



ATD-9905 BEAD SEATER INSTRUCTION MANUAL



FEATURES:

- ASME-Certified 5-Gallon Powder Coated Steel Tank
- Seats beads on all tires from 4" to 24.5" sizes
- Operates on standard shop air
- Built-in carrying handle for portability

READ INSTRUCTIONS THOROUGHLY BEFORE OPERATING

! California Prop 65 WARNING:

This product contains chemicals including lead, known to the State of California to cause cancer, birth defects, or other reproductive harm. **Wash hands after handling.**

General Safety Warnings:

 **WARNING:** The instructions and warnings contained in this manual should be read and understood before using or operating this tool. Do not allow anyone to use or operate this tool until they have read this manual and have developed a thorough understanding of how this tool works. Failure to observe any of the following instructions could result in severe personal injury to tool user and bystanders, or cause damage to the tool and property. Keep this manual for future reference.

 **Note:** The warnings and cautions discussed in this instruction manual cannot cover all possible conditions and situations that may occur. It must be understood by the operator that common sense and caution are factors which cannot be built into this product, but must be supplied by the operator.

 **WARNING:** Use safety equipment. Users and bystanders should use safety goggles or safety glasses with side shields which comply with current national standards, or when needed, a face shield. Use an ANSI approved dust mask or respirator when working around metal, wood, and chemical dusts and mists. This applies to all persons in the work area. Also use non-skid safety shoes, hardhat, gloves, dust collection systems, and hearing protection when appropriate.

 **WARNING:** Keep bystanders and children out of the work area while operating this tool.

 **WARNING:** Always keep your work area clean, uncluttered, and well lit. Cluttered or dark areas invite accidents and injuries. DO NOT work on floor surfaces that are slippery.

 **WARNING:** Do not operate this tool if you are tired or under the influence of alcohol, drugs, or medications that could affect your ability to use the tool properly.

 **WARNING:** Dress properly. Do not wear loose clothing or jewelry as they can be caught in moving parts. Wear restrictive hair covering to contain long hair.

 **WARNING:** Do not reach over or across running machines. Keep proper footing and balance at all times. Non-skid footwear is recommended when working.

Air Tools Specific Safety Warnings:

 **WARNING:** Air under pressure can cause severe injury. Never point an air tool at anyone or direct air at yourself or others. It could cause serious injury.

 **WARNING:** Always turn off the air supply, drain the hose of air pressure and detach the tool from the air supply before installing, removing or adjusting any accessory on this tool, or before performing any maintenance on this tool. Failure to do so could result in injury.

⚠️ WARNING: Always check for damaged, frayed or loose hoses and fittings. Have any defective or damaged parts replaced immediately by qualified personnel.

⚠️ WARNING: Do not carry Bead Seater by the hose. Do not keep air supply hose connected to the Bead Seater when operating it. Protect the hose from sharp objects and heat.

⚠️ WARNING: Always use air hose and couplings with a minimum working pressure rating of at least 1-1/2 times the maximum working pressure rating of the tool.

⚠️ WARNING: Do not open the Bead Seater air release valve when connecting the air supply hose.

⚠️ WARNING: When the Bead Seater is not in use, discharge air from the tank. If the Bead Seater is not to be used for a period of time, store in a clean and dry location at average room temperature.

📖 NOTE:

Typical Air Supply Installation

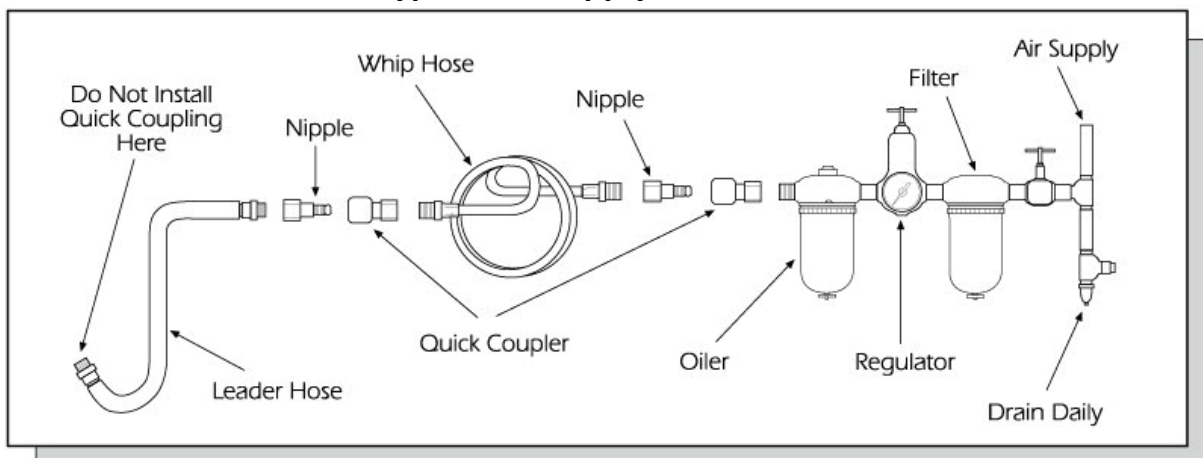

⚠️ WARNING: Always use clean, dry air. Dust, corrosive fumes and/or water in the airline will cause damage to the Bead Seater. Drain the air tank daily.

⚠️ WARNING: Inspect before each use. Do not use if broken, bent, cracked or damaged parts are noted. (Including warning label). If the Bead Seater appears damaged in any way, is missing parts, or operates abnormally, it shall be removed from service immediately. If the Bead Seater has been dropped, impacted suddenly, or dented, immediately discontinue use until product has been checked by qualified personnel. Labels and operator's manuals are available from the manufacturer.

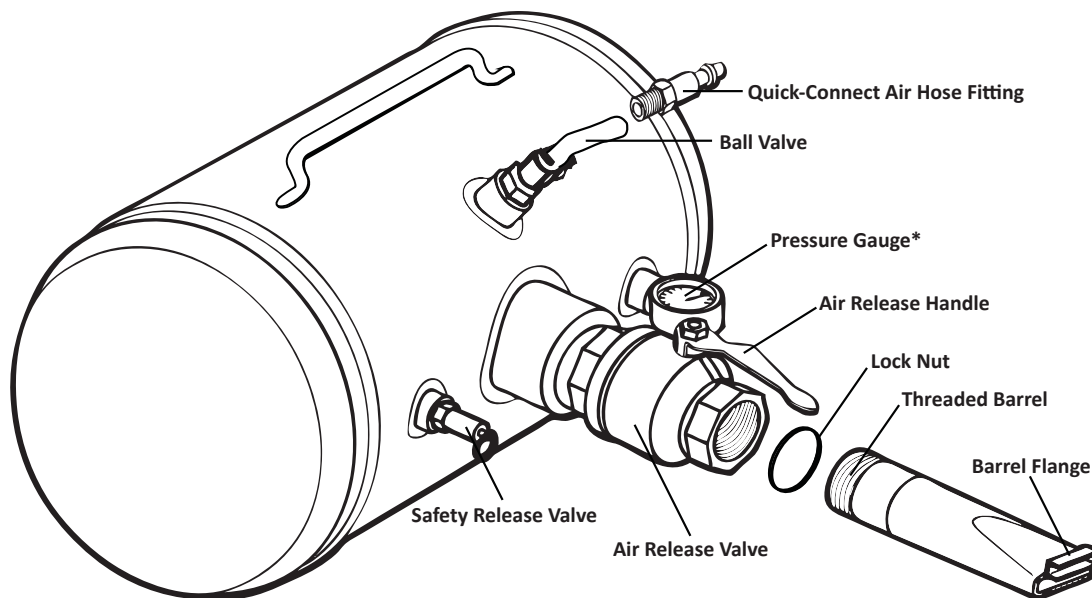

FIGURE 1

* - The pressure gauge is packed separately. Please wrap the threads with thread sealing tape to ensure leak free operation and use an open end wrench to thread tightly into the tank.

Install a quick coupler that fits your particular system (1/4" NPT). Working pressure of the unit is 80 - 130 psi. To install the barrel, screw the threaded end of the barrel into the discharge valve.

Using the ATD-9905 Bead Seater in the horizontal position: Install the barrel so the barrel flange is on the same side as the air release valve (as shown in figure 2).

Always inject air into the tire from the front or wide side of the wheel flange. Bead can be seated by placing the tire flat on the tire stand so the tire is slightly off the floor.

Tire bead should be seated on the bottom (narrow) flange of the wheel. Use the bead seater to inject air into the tire through an opening across from the valve stem.

Apply air to the valve stem at the same time by using your air hose.

Seating the bead in an upright position works better when there is a large gap between the tire and the wheel.

For upright bead seating, loosen the threadless connector nut and twist the barrel so the barrel flange is on the opposite side from the handle on the air release valve (as shown in figure 3). The back side of the tire should be seated against the wheel to trap the air. The ATD-9905 Bead Seater should always be attached to the front or wide flange of the wheel.

Tire and wheel must be in a firm position before injecting air. Release air from the bead seater while at the same time applying air to the valve stem by using your air hose.

The ATD-9905 Bead Seater can be filled from any service station air chuck. Portable and easy to use, the ATD-9905 Bead Seater is a durable tool that is affordable and will give you years of trouble free service.

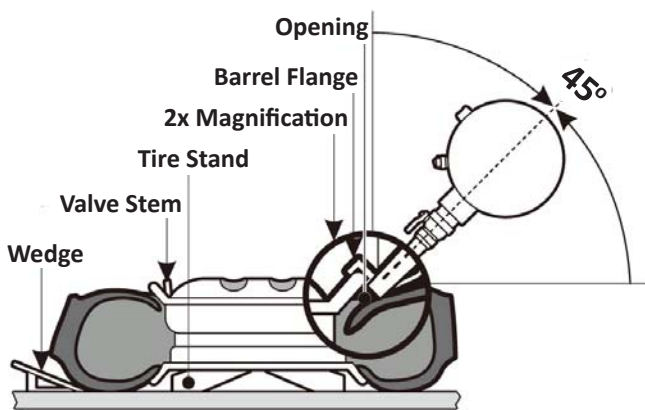

FIGURE 2

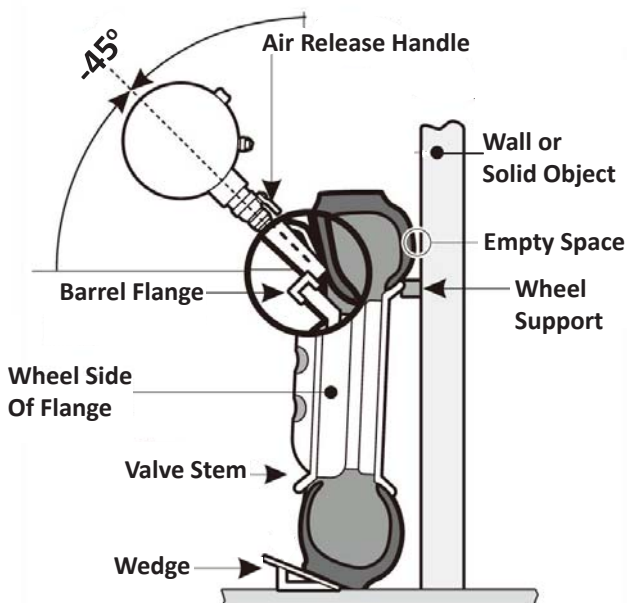
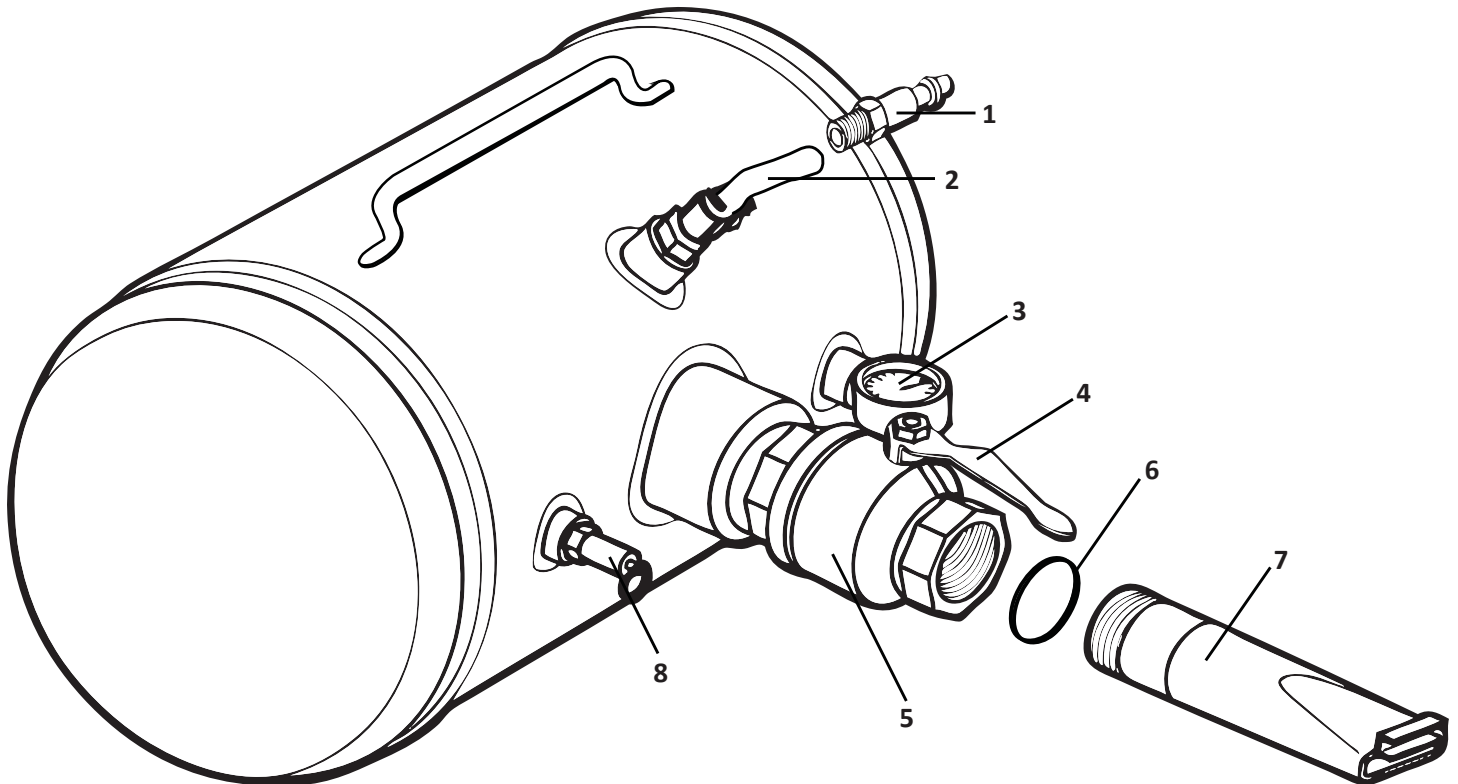

FIGURE 3



ITEM#	ORDERING PART#	PART DESCRIPTION
1	PRT9905-01	QUICK-CONNECT AIR HOSE FITTING
2	PRT9905-02	BALL VALVE
3	PRT9905-03	PRESSURE GAUGE
4	PRT9905-04	AIR RELEASE HANDLE ONLY
5	PRT9905-05	AIR RELEASE VALVE WITH HANDLE
6	PRT9905-06	LOCK NUT
7	PRT9905-07	THREADED BARREL
8	PRT9905-08	SAFETY RELEASE VALVE (130 PSI)



WARRANTY

1 YEAR REPLACEMENT WARRANTY

THIS WARRANTY AND CONFIRMED RECEIPT (S) SHOULD BE *RETAINED BY THE CUSTOMER* AT ALL TIMES

The warranty is only made available by returning the product to the point of sale.

Your supplier may elect to replace just the defective portion of this tool for you.

Your ATD-9905 is warranted for a period of 12 months from the original date of purchase.

The warranty given on this tool is against defects in workmanship and materials only. Any misuse, abuse or accidental and incidental damage is not covered by warranty. The following actions will also result in the warranty being void:

- If the tool shows signs of damage or defects caused by or resulting from abuse, accidents or alterations.
- If the tool is disassembled or tampered with in any way.