



ATD-7343 3 TON LOW PROFILE ALUMINUM FLOOR JACK OWNER'S MANUAL



Specifications:

Capacity	Min. Height	Max. Height	Handle Length	Overall Size	Saddle Diameter	Strokes to Max. Height	Weight
3 Tons	3-7/8"	18"	47-5/8"	26.3/8" L x 13" W x 7-7/8"	4-1/2"	6	55 lbs.

This hydraulic jack conforms to all "ANSI / ASME" safety standards.

⚠ WARNING ⚠
WARNING: This product may contain chemicals, including lead, known to the State of California to cause cancer, birth defects or other reproductive harm. *Wash hands after handling.*

SAFETY WARNING AND PRECAUTIONS

General Safety Warnings:

 **WARNING:** The instructions and warnings contained in this manual should be read and understood before using or operating this tool. Do not allow anyone to use or operate this tool until they have read this manual and have developed a thorough understanding of how this tool works. Failure to observe any of the following instructions could result in severe personal injury to tool user and bystanders, or cause damage to the tool and property. Keep this manual for future reference.

 **Note:** The warnings and cautions discussed in this instruction manual cannot cover all possible conditions and situations that may occur. It must be understood by the operator that common sense and caution are factors which cannot be built into this product, but must be supplied by the operator.

 **WARNING:** Use safety equipment. User and bystanders should use safety goggles or safety glasses with side shields which comply with current national standards, or when needed, a face shield. Use an ANSI approved dust mask or respirator when working around metal, wood, and chemical dusts and mists. This applies to all persons in the work area. Also use non-skid safety shoes, hardhat, gloves, dust collection systems, and hearing protection when appropriate.

 **WARNING:** Keep bystanders and children out of the work area while operating this tool.

 **WARNING:** Always keep your work area clean, uncluttered, and well lit. Cluttered or dark areas invite accidents and injuries. DO NOT work on floor surfaces that are slippery.

 **WARNING:** Do not operate this tool if you are tired or under the influence of alcohol, drugs, or medications that could affect your ability to use the tool properly.

 **WARNING:** Dress properly. Do not wear loose clothing or jewelry as they can be caught in moving parts. Wear restrictive hair covering to contain long hair.

 **WARNING:** Do not reach over or across running machines. Keep proper footing and balance at all times. Non-skid footwear is recommended when working.

Product Specific Warnings:

Non-compliance with these warnings may result in injury or damage to the jack or the vehicle.

 **WARNING:** NEVER use hydraulic jack as a stand-alone device. After lifting, **IMMEDIATELY** support the lifted vehicle with a pair of appropriately rated jack stands. **NEVER** place ANY portion of your body beneath the vehicle when lifting OR lowering.

 **WARNING:** Do not modify the jack in any way.

 **WARNING:** Never exceed the rated capacity of the jack.

 **WARNING:** This jack is a lifting device only and should never be used to move the vehicle.

 **WARNING:** The jack should be supported on a solid and level ground. Never use the jack in a surface where it may sink into the ground.

! WARNING: Ensure that there are no persons inside the vehicle to be lifted. Switch off the engine and apply the brake.
Chock each unlifted tire in BOTH directions as shown below.

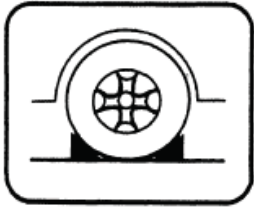

! WARNING: Position the jack under the manufacturer's recommended lifting point for the vehicle. Off centered loads can slip and accidents may result.

! WARNING: During raising and lowering of the load, precautions should be taken to avoid movement of the vehicle.

! WARNING: Traffic may cause the raised vehicle to rock during roadside use of the jack.

! WARNING: Never work on, under or around a raised vehicle supported only by a hydraulic jack. Always use adequately rated jack stands.

! WARNING: Never position any part of your body near the movable parts of the jack.

! WARNING: Ensure that there are no persons, tools or obstructions underneath the vehicle prior to lowering.

! WARNING: Do not adjust the overload bypass valve under any circumstance.

PRIOR TO OPERATION:

Air may become trapped in the hydraulic system during transit.

To Purge Air

1. Insert the handle into the socket and secure it with the set screw provided.
2. Turn the handle counterclockwise until release valve is open; pump the jack several times to purge the accumulated air in the system.
3. Turn the handle clockwise to close the release valve. The jack is now ready to use.

OPERATING INSTRUCTIONS:

To Lift a Vehicle:

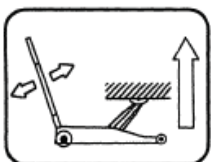

Turn the handle clockwise. Move the handle up and down. Use the full stroke of the piston for greater speed.

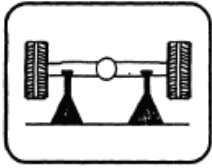

Support the vehicle with appropriate jack stands.

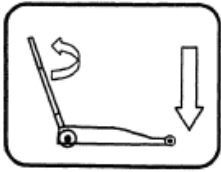

Lift the vehicle to remove the jack stands, ensuring that there are no persons or obstructions under the vehicle. Turn the handle counter-clockwise.

MAINTENANCE:

Important: Both the maintenance and repair of the jack may only be performed by qualified persons, who have sufficient knowledge of the hydraulic system used in these jacks

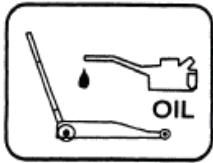

Regularly lubricate the moving parts in the wheels, arms, handle and pump roller pin. Only original replacement parts should be used.

⚠️ EXTREMELY IMPORTANT: NEVER use brake fluid OR transmission fluid for lubrication, or for filling the hydraulic system. Use ONLY quality hydraulic jack oil for lubrication and filling of the hydraulic system.

- When the jack is not in use, make sure the lifting arm is fully retracted to avoid corrosion.
- Replace the hydraulic fluid in the reservoir at least once a year. To check the hydraulic fluid level, lower the lifting arm completely.
- The hydraulic fluid level should be just below the filler plug. If the oil is too low, the jack will not raise to its advertised maximum height. Replenish if necessary, and reinstall the rubber filler plug. Do not overfill the jack. Excessive hydraulic oil may render the jack inoperative.
- Inspect the jack before each use. Take corrective action or remove the jack from service if any of the following problems are found:
 - A. Cracked or damaged frame
 - B. Leaking hydraulic fluid
 - C. Scored, damaged piston rod
 - D. Loose hardware
 - E. Modified equipment

Keep warning labels and instructional decals clean and readable. You may use a mild soap solution to wash external surfaces of the jack.

TROUBLESHOOTING:



CAUTION: To prevent personal injury, all inspection, maintenance, and repair procedures must be performed when the jack is free of load.

Trouble	Cause	Solution
Jack Does Not Lift	1. Release valve is open	1. Verify the release valve is closed. Release valve may need cleaning
	2. Low/no hydraulic fluid in reservoir	2. Fill with approved hydraulic fluid and bleed system
	3. Air trapped in hydraulic system	3. Follow the purge air procedure
	4. Load is above capacity of jack	4. Use the correct equipment
	5. Delivery valve and/or bypass valve not working correctly	5. Clean to remove dirt or foreign objects from the system. Replace hydraulic fluid
	6. Seals worn or defective	6. Replace seals
Jack lifts only partially	1. Too much or not enough hydraulic fluid	1. Check hydraulic fluid level
Jack advances slowly	1. Pump not working correctly	1. Rework pump
	2. Seals leaking	2. Replace seals/O-rings
Jack lifts load, but doesn't hold	1. Cylinder packing is leaking	1. Replace packing
	2. Valve not working correctly. (Suction, delivery, release or bypass)	2. Inspect valves. Replace if necessary
	3. Air trapped in hydraulic system	3. Follow the purge air procedure
Jack leaks hydraulic fluid	1. Worn or damaged seals	1. Replace seals
Jack will not retract	1. Release valve is closed	1. Open the release valve by turning the handle counter-clockwise (CCW). Maybe necessary to clean release valve



NOTE: Should you need assistance with parts, service or warranty, please contact your distributor or point of sale.

ATD®

ATD-7343

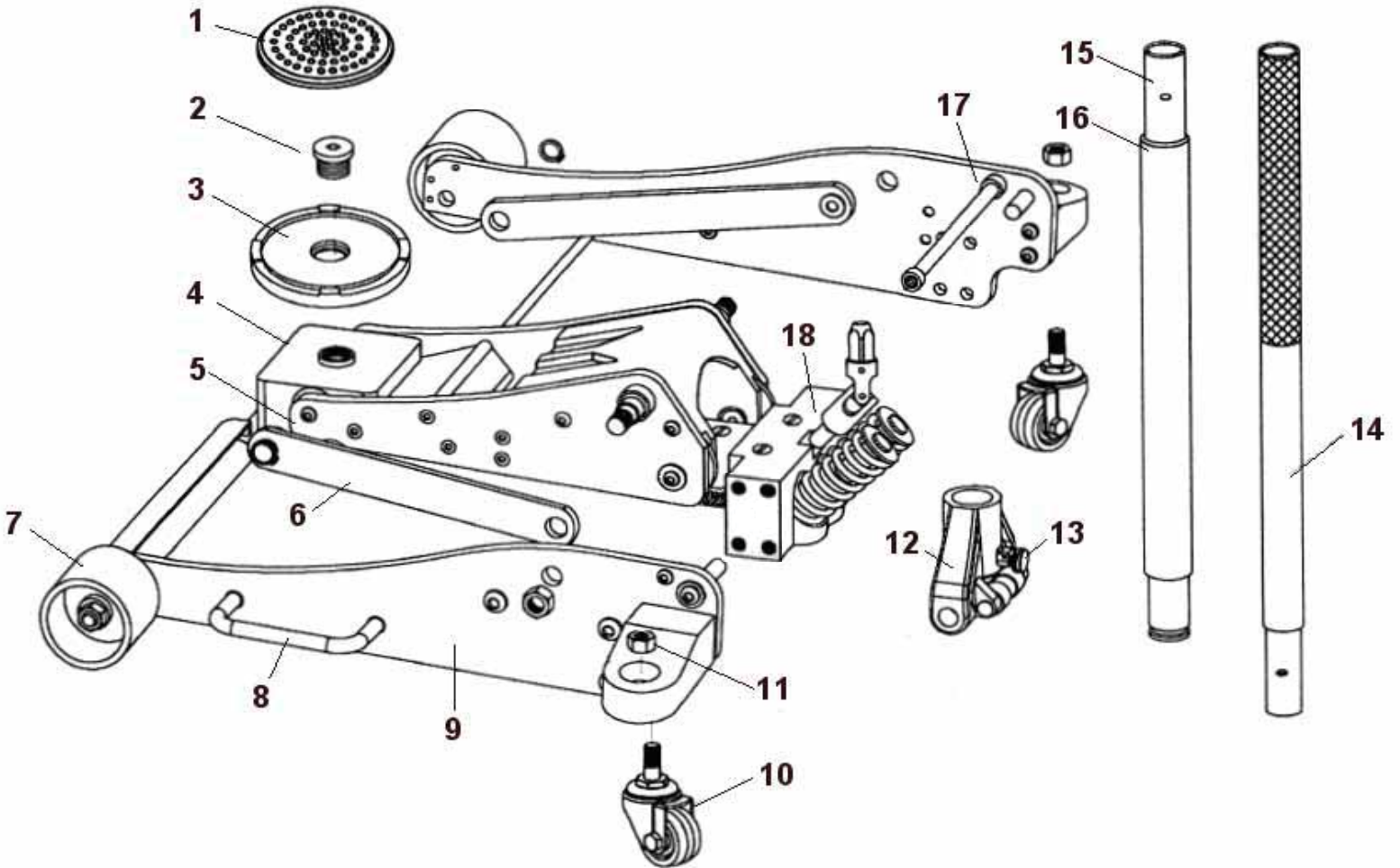

ITEM#	ORDERING PART#	PART DESCRIPTION
1	PRT7343-01	P01 - SADDLE PAD
2	PRT7343-02	P02 - SADDLE SCREW
3	PRT7343-03	P03 - SADDLE
4	PRT7343-04	P04 - SADDLE BASE
5	PRT7343-05	P05 - LIFT ARM ASSEMBLY
6	PRT7343-06	P06 - RADIUS ROD
7	PRT7343-07	P07 - FRONT WHEEL
8	PRT7343-08	P08 - CARRYING PLATE
9	PRT7343-09	P09 - SIDE PLATE
10	PRT7343-10	P10 - REAR CASTER ASSEMBLY

ITEM#	ORDERING PART#	PART DESCRIPTION
11	PRT7343-11	P11 - NUT, M12
12	PRT7343-12	P12 - HANDLE YOLK
13	PRT7343-13	P13 - HANDLE SET SCREW
14	PRT7343-HD	HD - COMPLETE HANDLE ASSEMBLY
15	PRT7343-HD	HD - COMPLETE HANDLE ASSEMBLY
16	PRT7343-HD	HD - COMPLETE HANDLE ASSEMBLY
17	PRT7343-17	P17 - TIE ROD
18	PRT7343-18	P18 - POWER UNIT ASSEMBLY
N/S	PRT7343-RK	PRK - COMPLETE O-RING AND SEAL KIT