

Owner's Manual & Assembly Guide



! caution
sharp edges *
 Gloves must be worn at all times to reduce risk of injury!

Model No. CPH122007 CPH122007EU
 CPHC122007 CPHC122007EU

12' x 20'
 Nominal Size

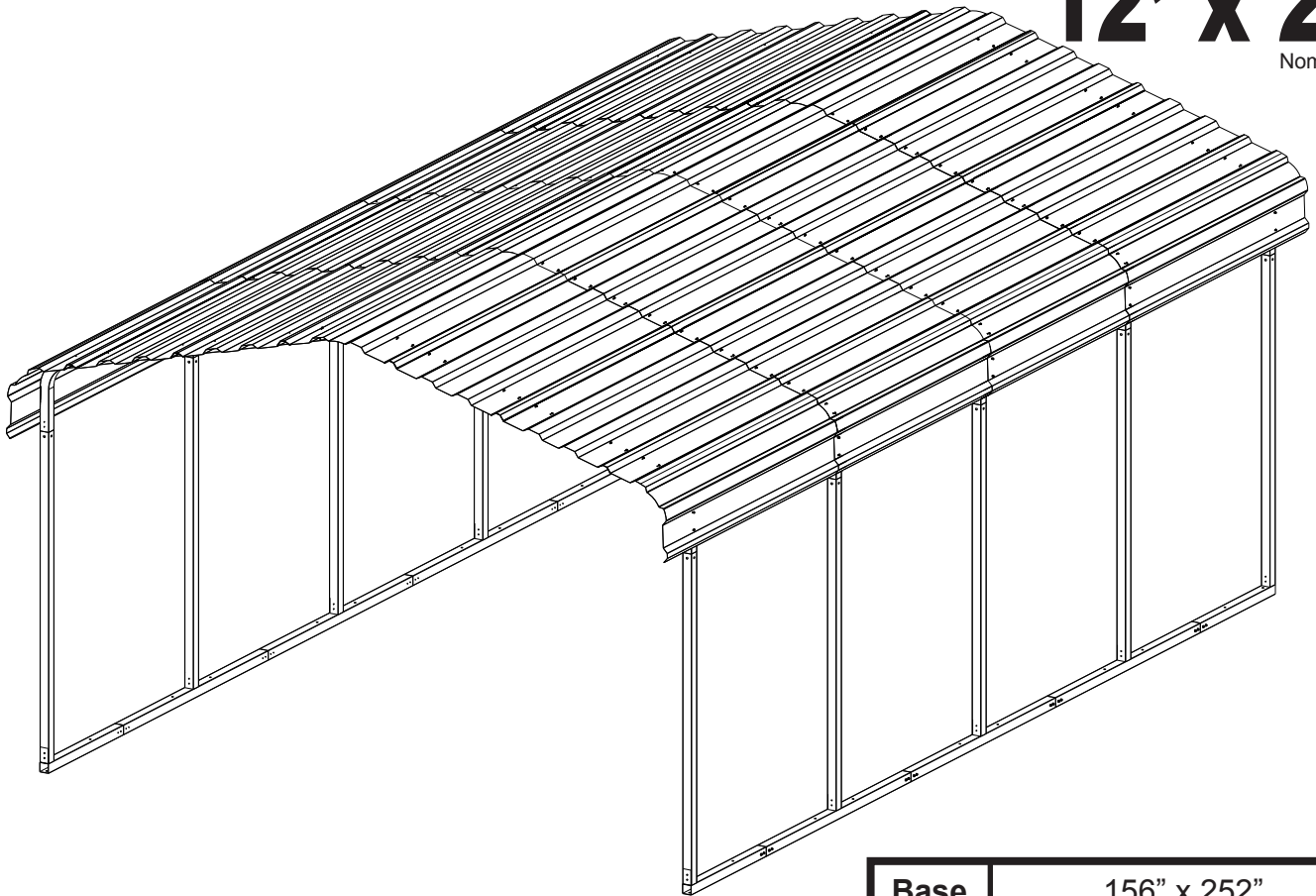

Base Size 156" x 252"
 396 cm x 640 cm

BUILDING DIMENSIONS

† Size rounded off to the nearest foot

Approx.† Size	Storage Area	Exterior Dimensions (Roof Edge to Roof Edge)			Interior Dimensions			Entrance		
		Width	Depth	Height	Width	Depth	Height	Height (max)	Height (min)	
12' x 20'	234 Sq. Ft. 1792 Cu. Ft.	146"	237"	102"	142"	237"	100"	142"	100"	82"
3,7 m x 6,1 m	21,7 m ² 50,8 m ³	371 cm	602 cm	259 cm	361 cm	602 cm	254 cm	361 cm	254 cm	208 cm

* See Inside for Detailed Safety Information.

SAFETY & MAINTENANCE

Safety precautions *MUST* be followed at all times throughout the construction of your building!

sharp edges

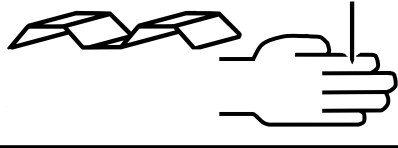

Care must be taken when handling various pieces of your building since many contain sharp edges. Please wear work gloves, eye protection and long sleeves when assembling or performing any maintenance on your building.

always practice proper tool safety



Practice caution with the tools being used in the assembly of this building. Be especially familiar with the operation of all power tools.

beware of wind



Do NOT attempt to assemble your building on a windy day. The large panels can catch the wind like a "sail", causing them to be whipped around making construction difficult and unsafe.

Do NOT attempt to assemble your building before double checking that you have all the parts indicated on the parts list as well as all hardware. Any building left partially assembled may be seriously damaged by even light winds.

don't focus weight on roof

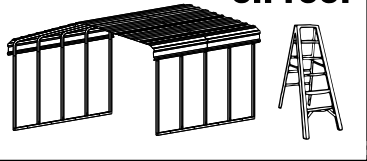

NEVER concentrate your weight on the roof of the building. When using a step ladder make sure that it is fully open and on even ground before climbing on it.

no children or pets at worksite



Keep children and pets away from the worksite during construction and until the building is completely assembled. This will help avoid distractions and any accidents which may occur.

IMPORTANT NOTE ON ANCHORING

- Your building **MUST** be anchored to prevent wind damage. See anchoring page for more info.
- You must also have a temporary anchoring system in place in case you need to take a break from assembly.

Exterior Care:

For a long lasting finish, clean and wax the exterior surface. We recommend washing with a mild soap solution. DO NOT use power washing to clean your shed. Using a spray automotive type wax periodically on the exterior is highly recommended if you are in a high humidity or coastal climate region.

Combustibles and corrosives must be stored in air tight containers designed for chemical and/or combustible storage. Corrosive chemicals such as fertilizers, pesticides and herbicides should be cleaned off the interior and exterior surfaces immediately. Rust caused by chemical damage is not covered by the warranty.

Rust protection precautions may help to stop rust from developing, or stop it quickly as soon as it appears.

- Avoid nicking or scraping the coating surface, inside and out.
- Keep roof and base perimeter free of debris and leaves which may accumulate and retain moisture. These can do double damage since they give off acid as they decay.
- Touch up scrapes or nicks and any area of visible rust as soon as possible. Make sure the surface is free of moisture, oils, dirt or grime and then apply an even film of high quality touch-up paint.
- Various paint manufacturers provide products for rust treatment and coverage. If surface rust does appear on your shed we recommend treating those areas as soon as possible, following the paint supplier of your choice instructions.
- Our customer service department can provide the paint tinting formula for matching the color of your shed. We also have touch-up paint available for repairing small nicks and scratches.

Roof: Keep the roof clear of leaves and snow. Heavy amounts of snow on the roof can damage the building making it unsafe to enter.

Fasteners: Regularly check fasteners and retighten as necessary.

General: Wash off inked part numbers on coated panels with soap and water.

Please note, Manufacturer cannot be held responsible for any consequences due to buildings that are not installed per these instructions, or for damage due to weather conditions or acts of God.

Keep these assembly instructions and owner's manual for future reference.

ASSEMBLY TIPS & TOOLS

Watch the Weather Closely: Be sure the day you choose to install your building is dry and calm. Do **NOT** attempt to assemble your building on a windy day. Be careful on wet or muddy ground.

Use Teamwork: Two or more people are required to assemble your building. One person can hold the parts or panels in place while the other person fastens them together and handles the tools. This makes the process of assembling your building faster and safer.

Tools and Materials: Here is a list of some basic tools and materials you will need to assemble your building. Decide which method of anchoring and the type of base you will use to make a complete list of the materials you will need.

WHAT YOU NEED

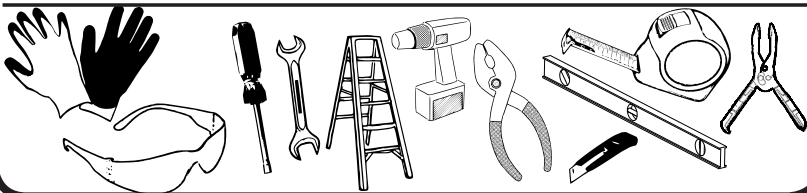

- Work Gloves
- Safety Glasses
- Nut Driver or Wrench
- Step Ladder 8'
- Power Drill (Cordless, Variable Speed)
- Pliers
- Utility Knife or Scissors
- Carpenter's Level
- Tape Measure
- Clamp

RECOMMENDED TIME SAVERS



- Square
- String (for squaring the frame)
- Awl (to align holes)

BASE PREPARATION TOOLS

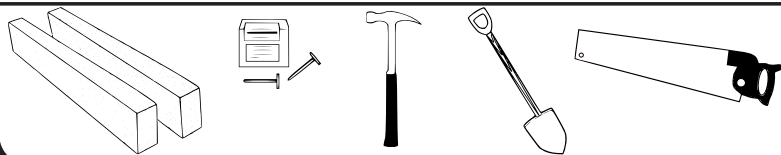

- Lumber and/or Concrete
- Hammer and Nails
- Spade or Shovel
- Hand Saw or Power Saw

How to Select and Prepare Your Building Site: Before you start to assemble your building, you will want to decide on a good location. The best location is a level area with good drainage.

- Allow enough working space so it is not difficult to move parts into position for assembly. Also, there needs to be enough space outside the building to be able to fasten the panel screws from the outside.
- Before assembling any parts, your base should be constructed and an anchoring system should be ready to use.

PARTS

804860

(A)

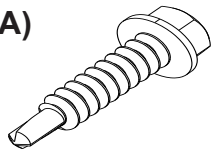

(x366)

804861

(B)

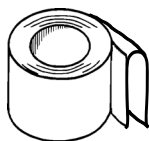

(x1)

00828

(C)

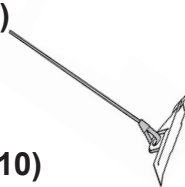

(x10)

00825

(D)

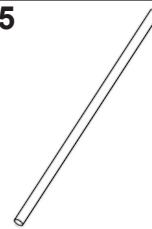

(x1)

10016

(E)

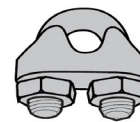

(x10)

805031

(F)



(x2)

803562

(G)



(x3)

803468

(H)



(x10)

804859

(I)



(x8)

803565

(J)

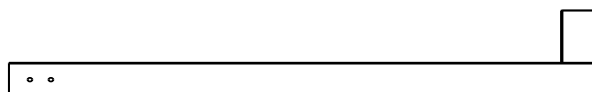

(x4)

803466

(K)

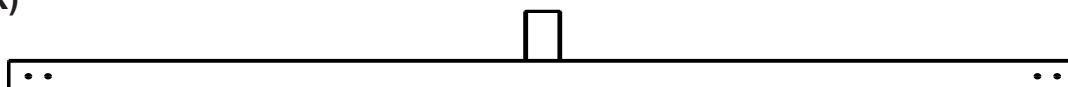

(x6)

803467

(L)

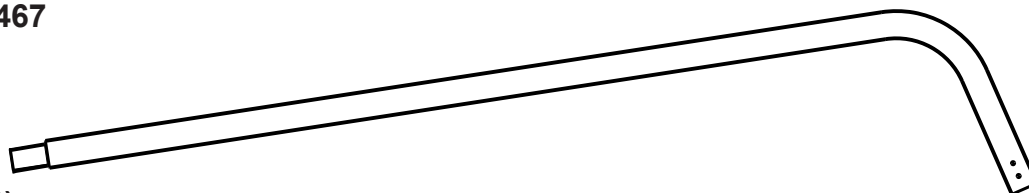

(x10)

11061

(M)

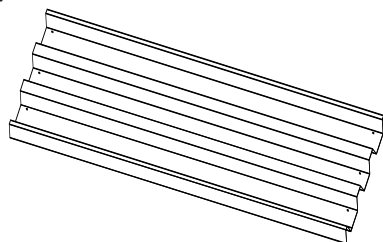

(x14)

11060

(N)

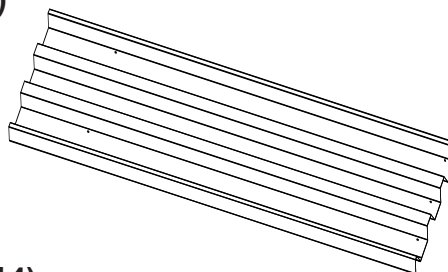

(x14)

66856

(O)



(x3)

ASSEMBLY BY KEY NO.

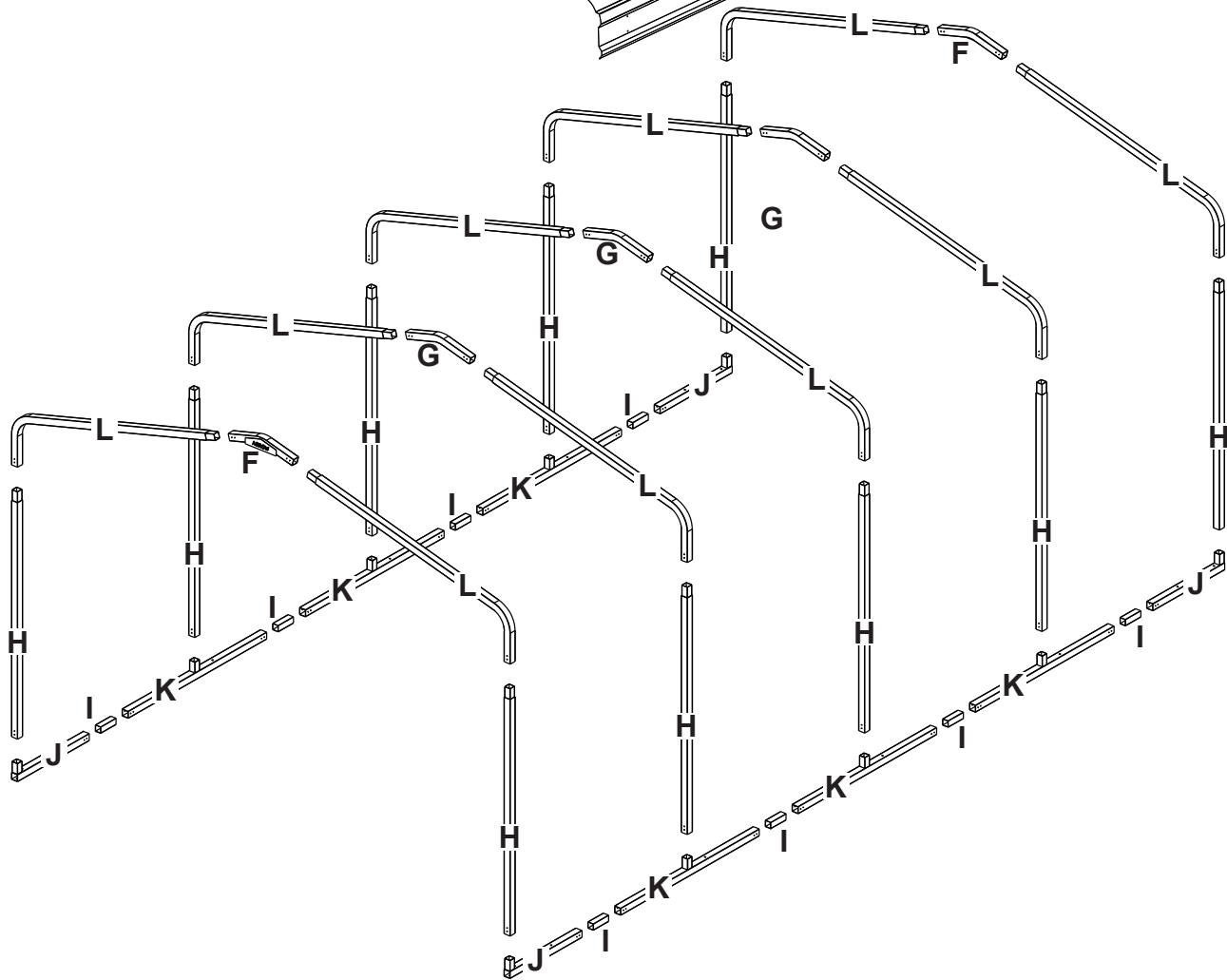
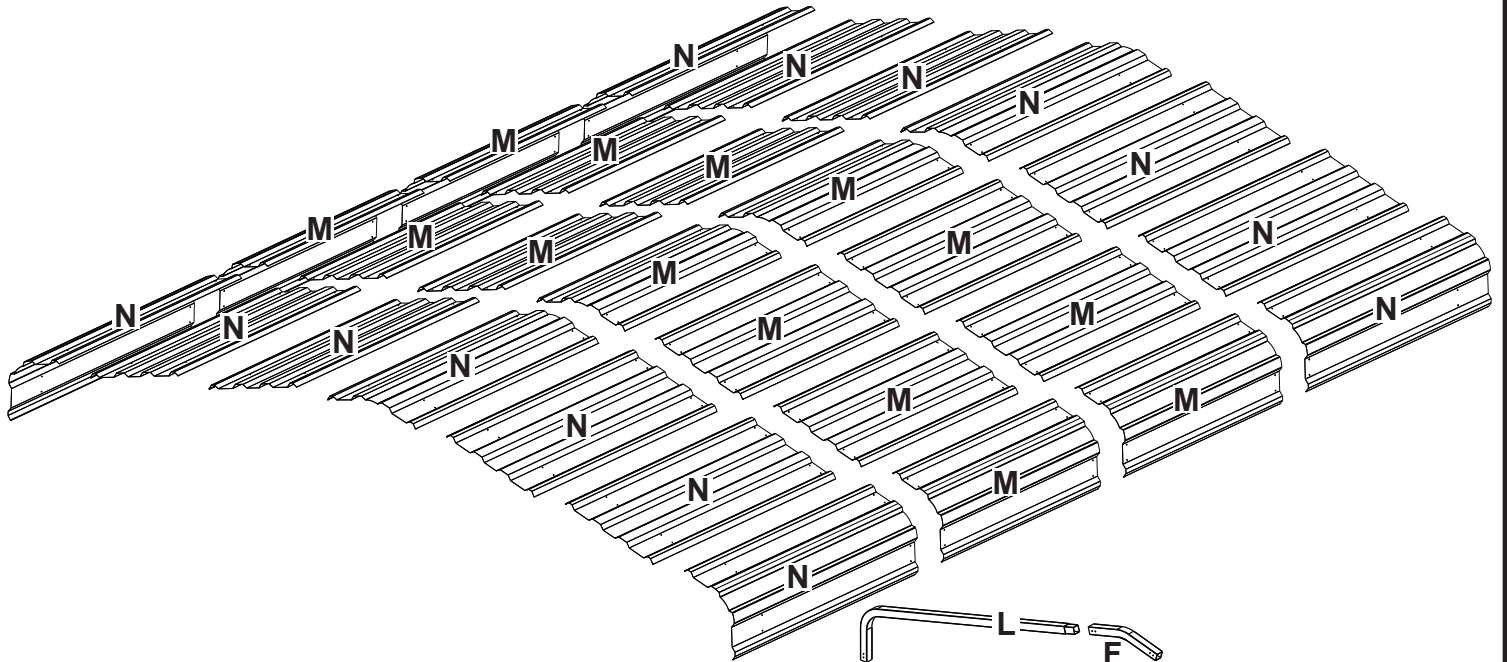

Extension Modules

NOTE: 12' x 20' x 7' is the BASE frame dimension. Your model may have more middle ribs than shown in the illustrations. You will receive one additional middle rib and seven middle roof panels for every additional 4.5 ft. of building length that you purchase. The basic frame assembly remains the same.

FRAME OVERVIEW

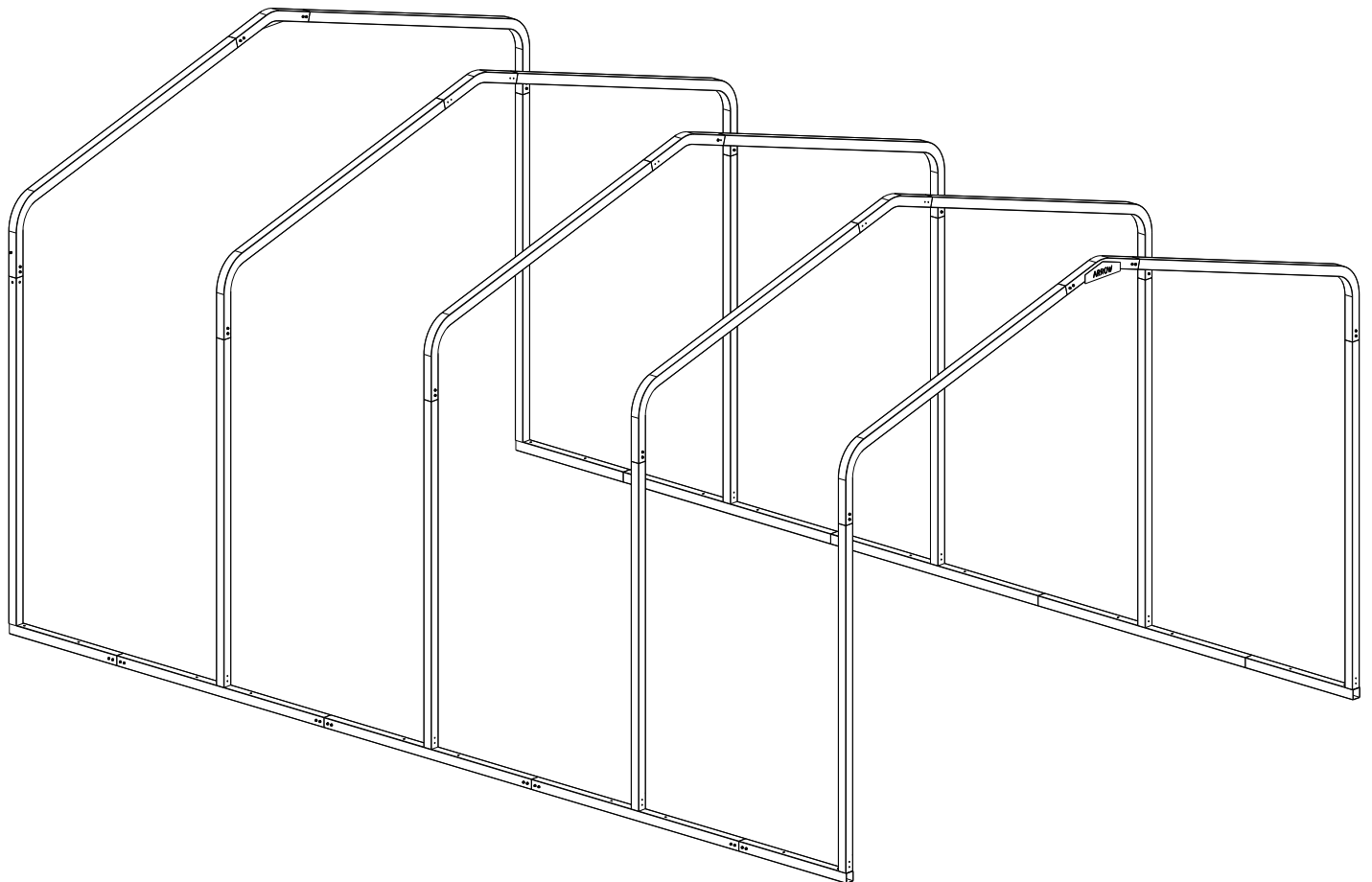

NOTE: The 12'W x 20'L x 7'H is a base building. Buildings longer than 15' will receive 2 additional boxes for each 4.5', one frame box with 1 middle rib and one panel box with 7 middle panels. These frames and panels are inserted in the middle section of the base building.

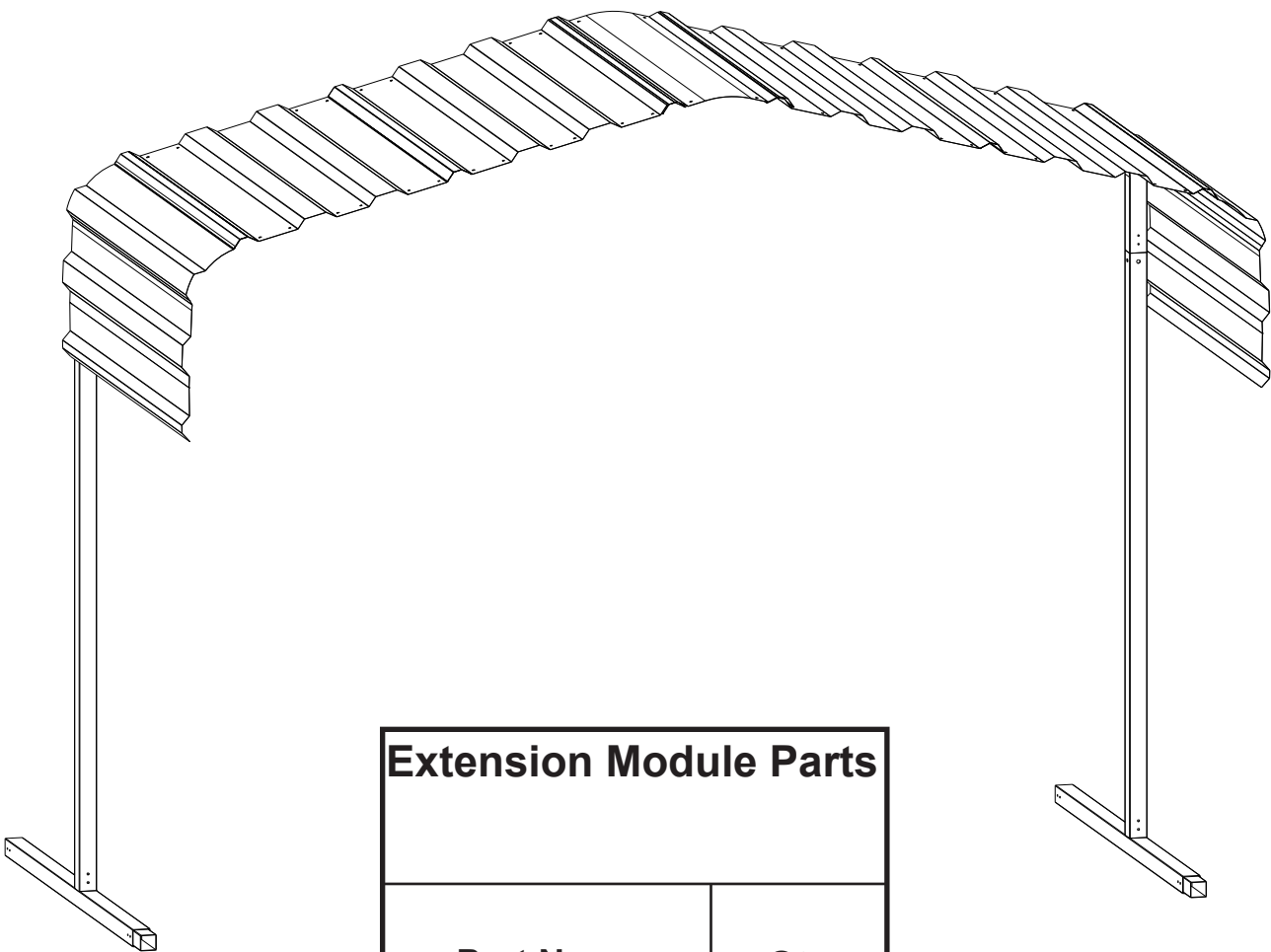

Extension Module Parts		
Part Name		Qty
G	803562	1
H	803468	2
I	804859	2
K	803466	2
L	803467	2
M	11061	7

Step 1

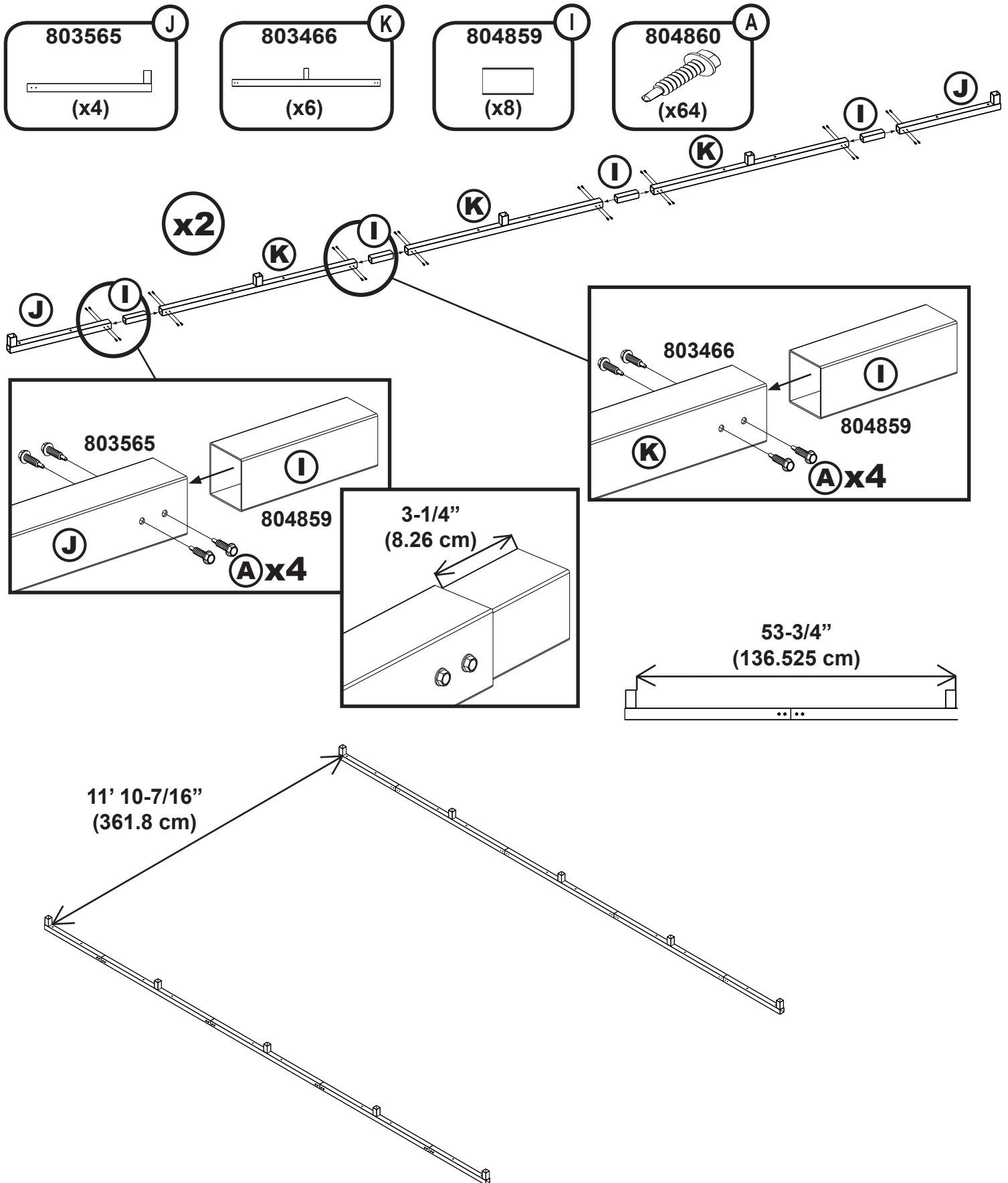

Step 2

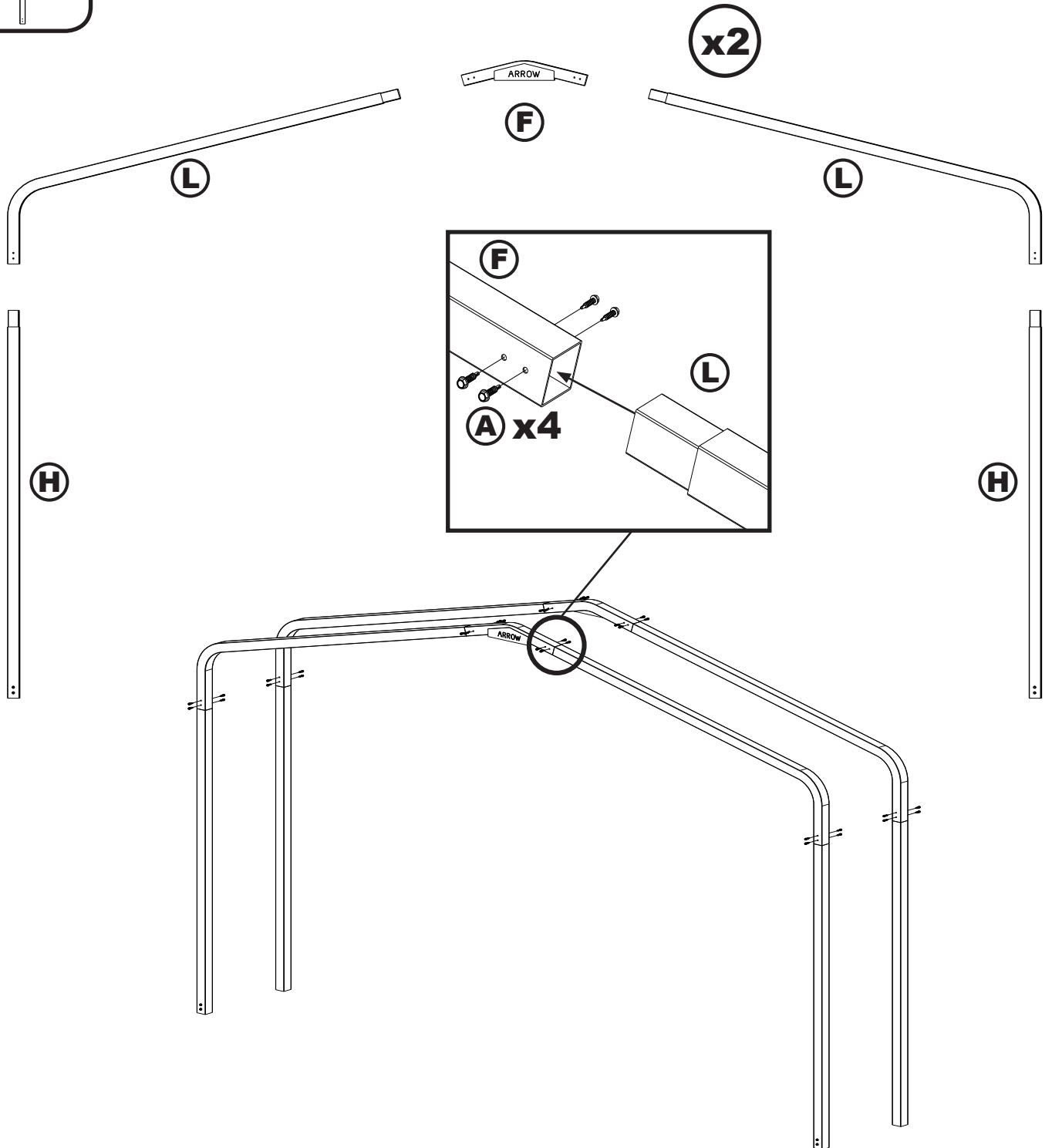
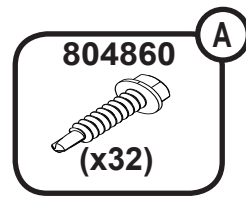
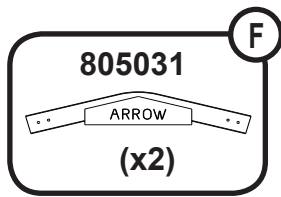
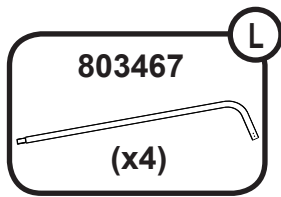
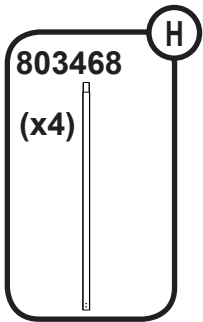

Step 3

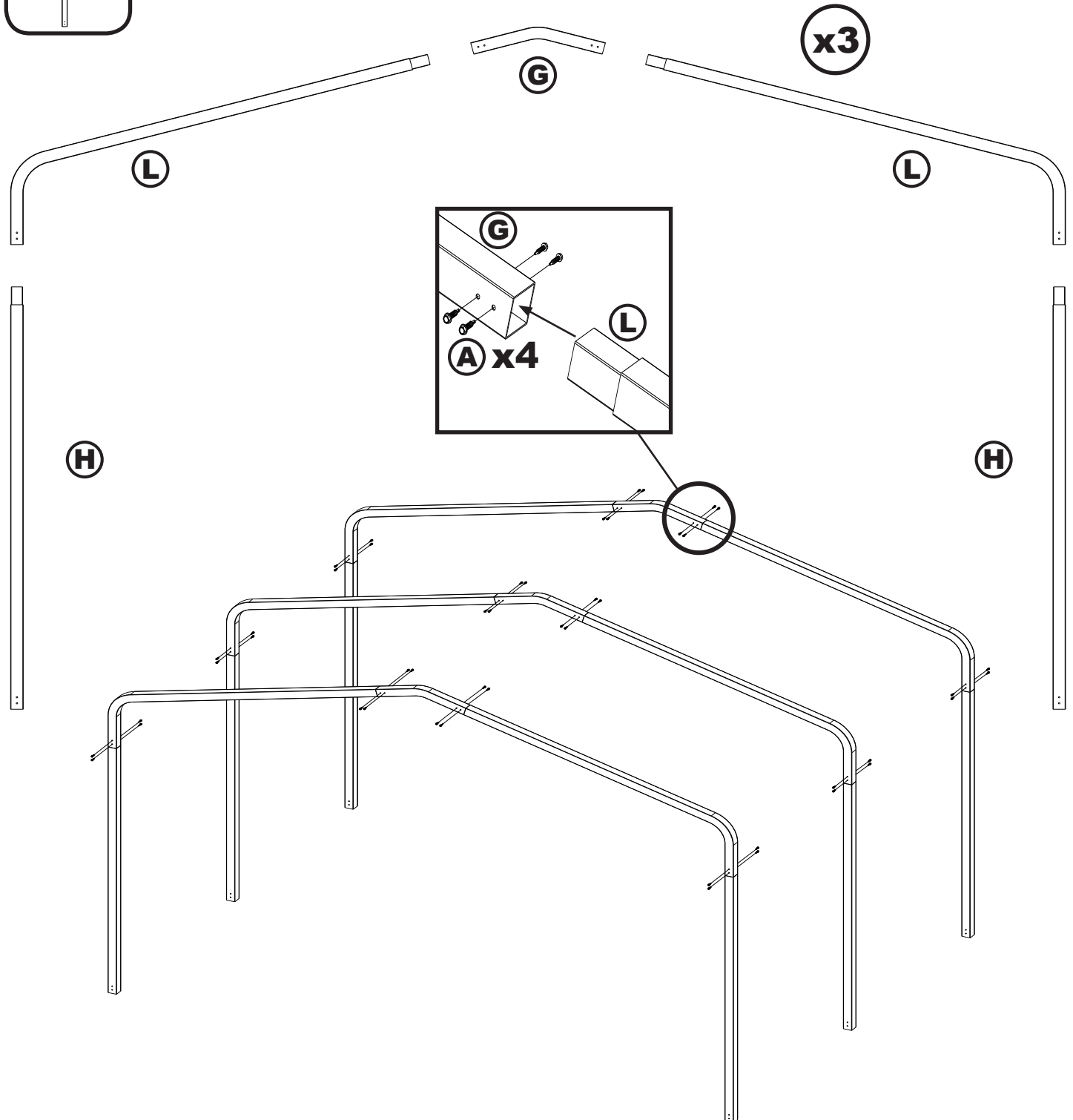
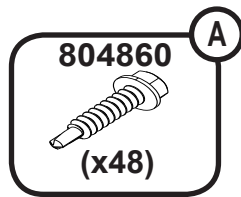
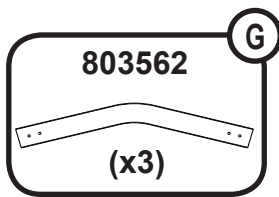
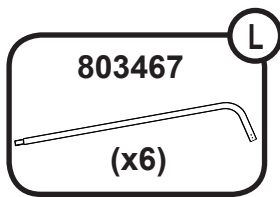
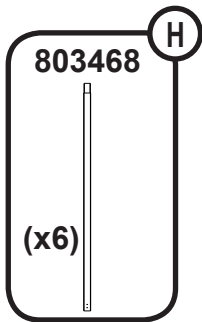

Step 4

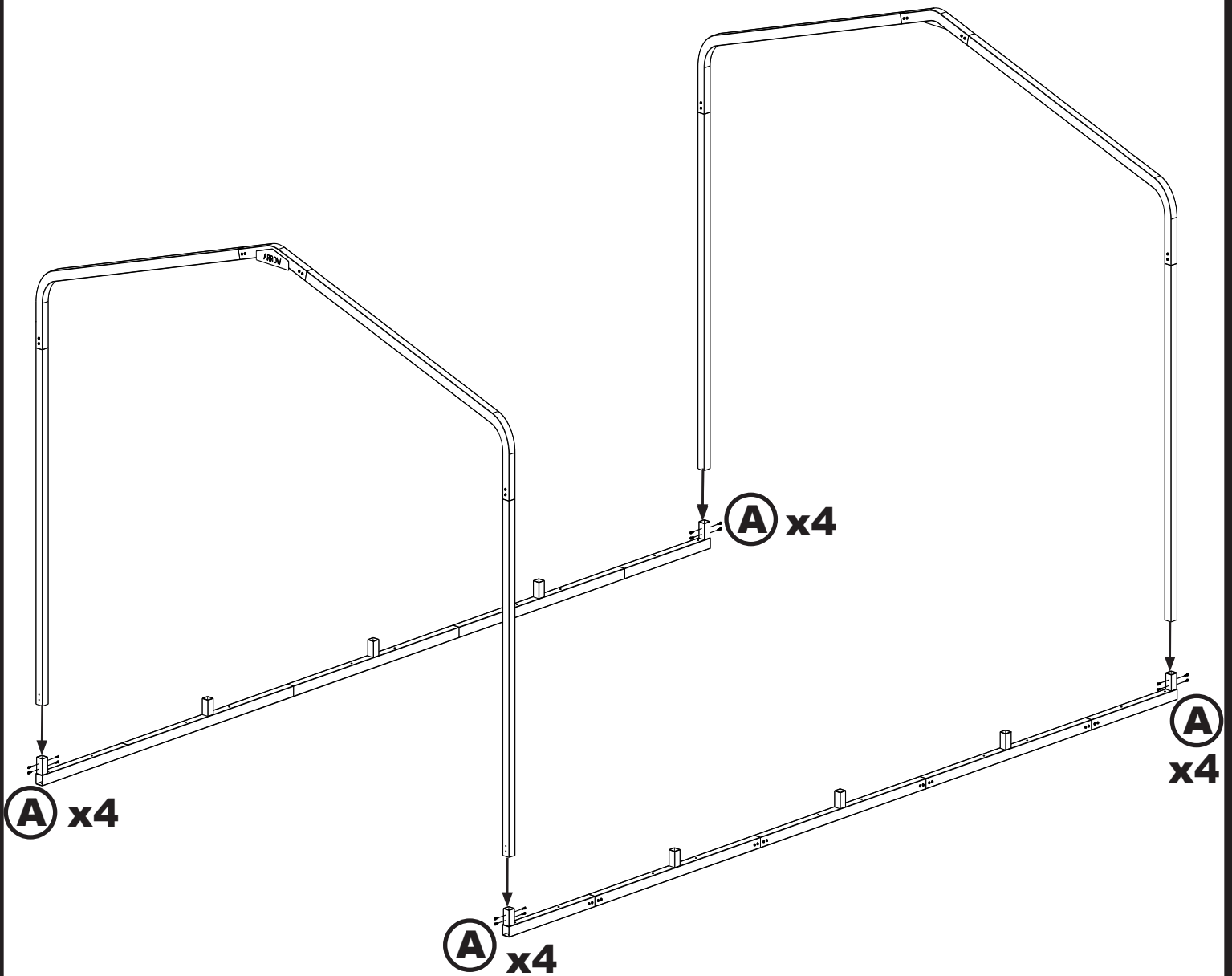
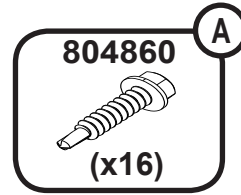
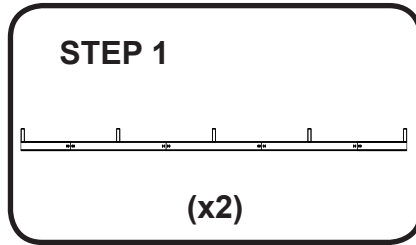
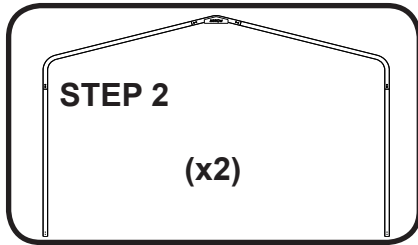

Step 5

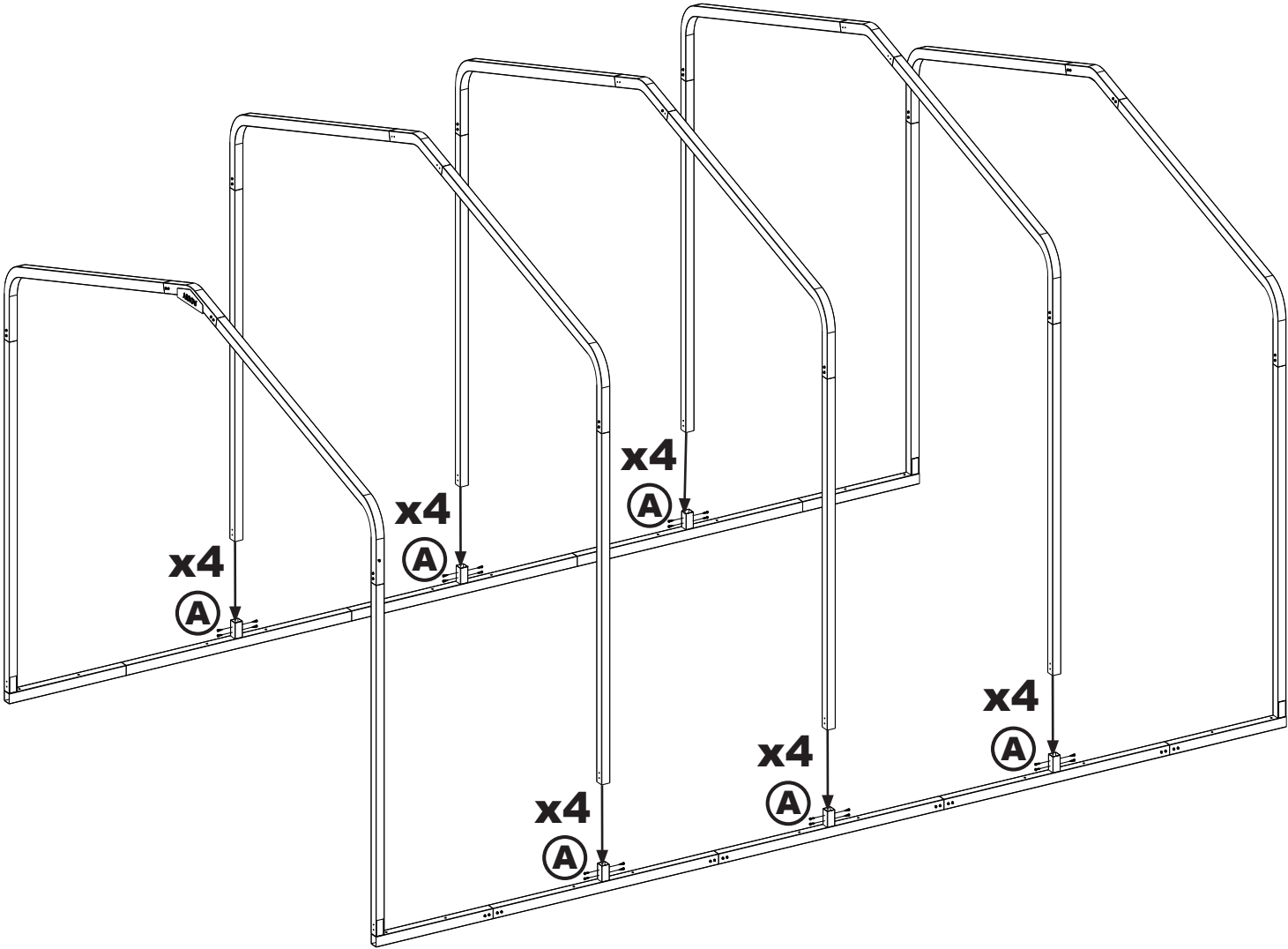
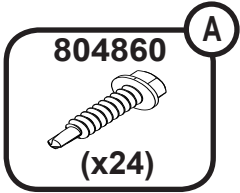
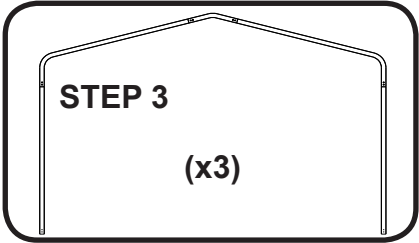

Step 6

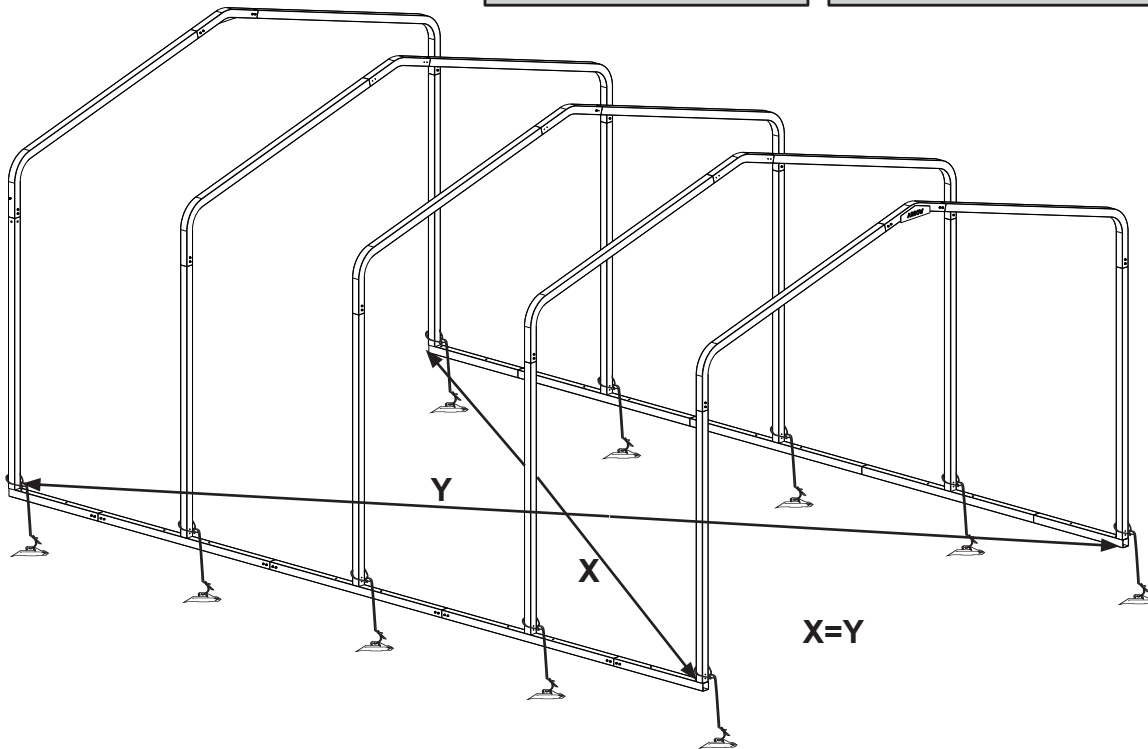
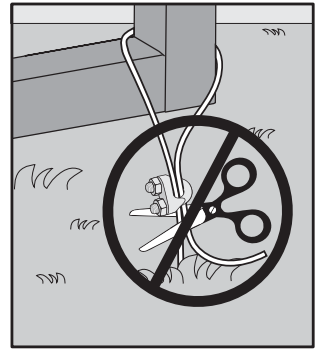
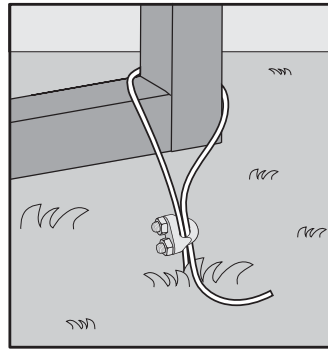
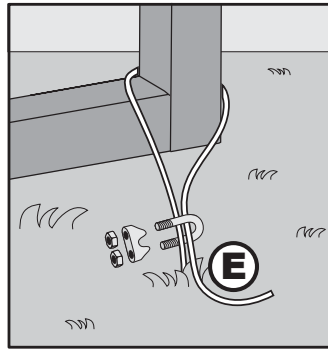
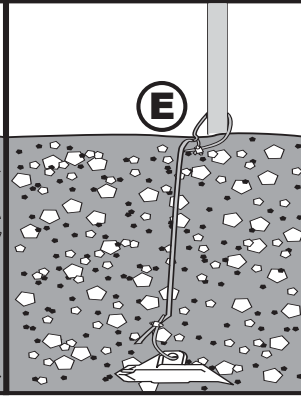
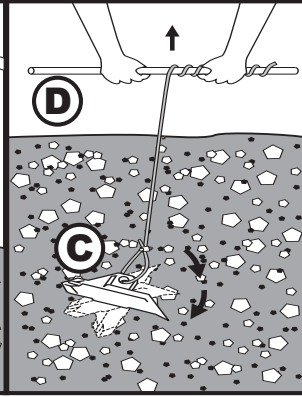
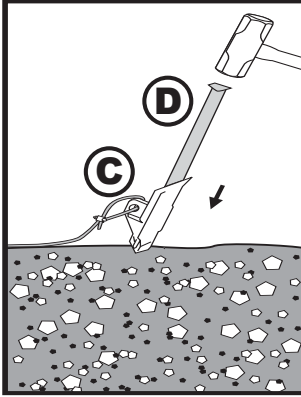
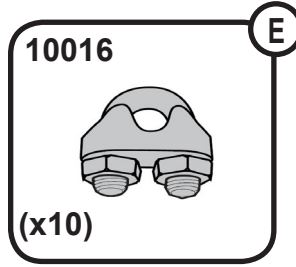
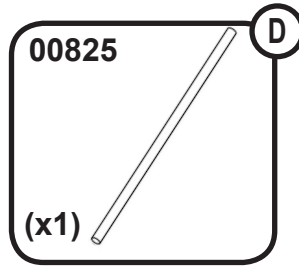
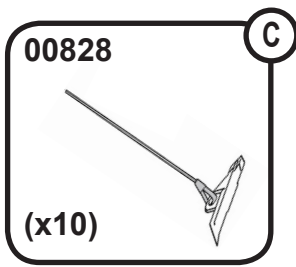

Step 7

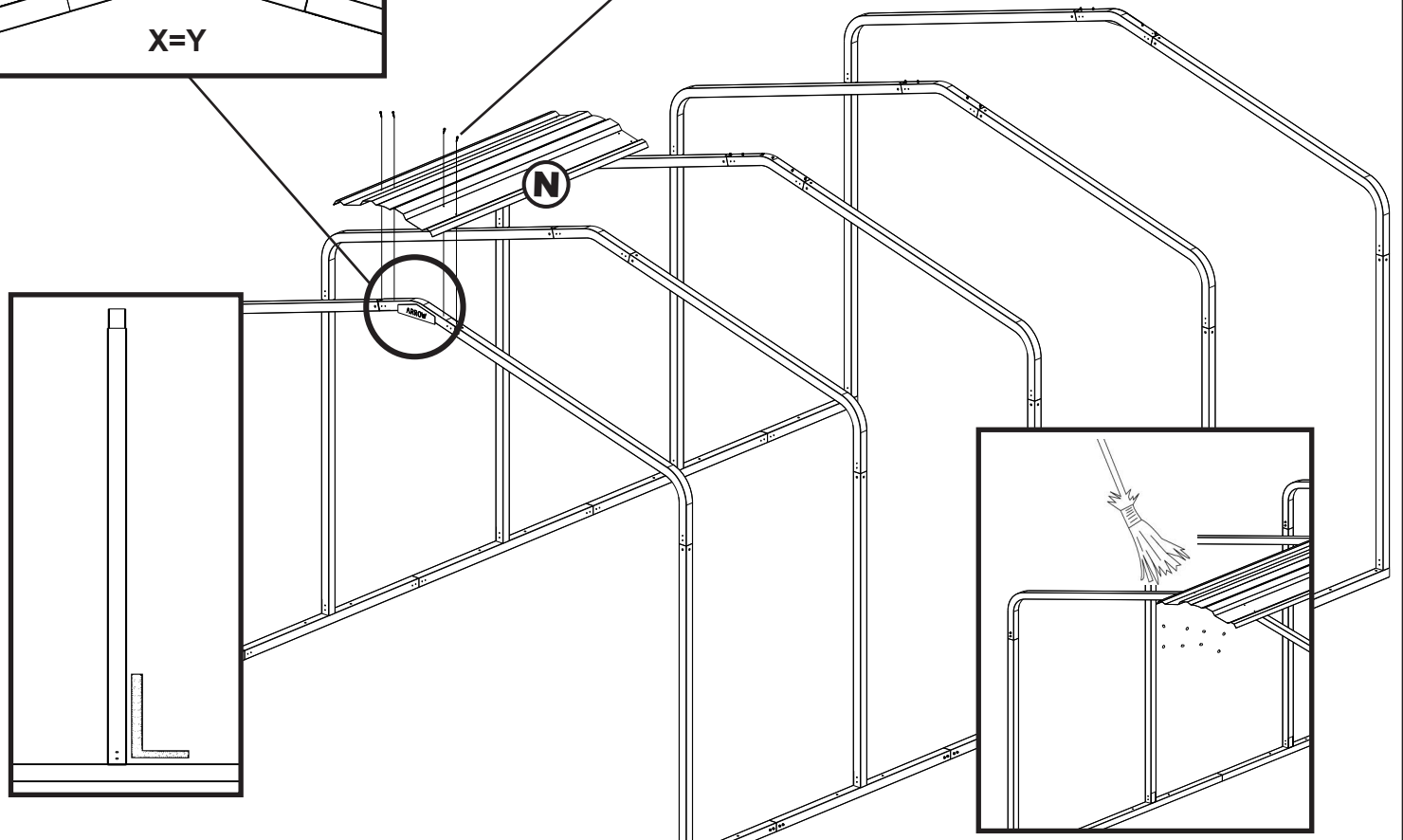
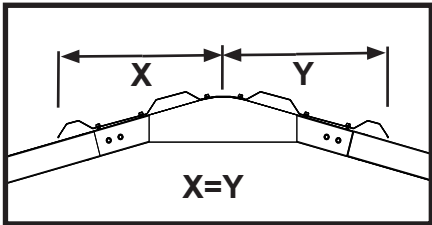
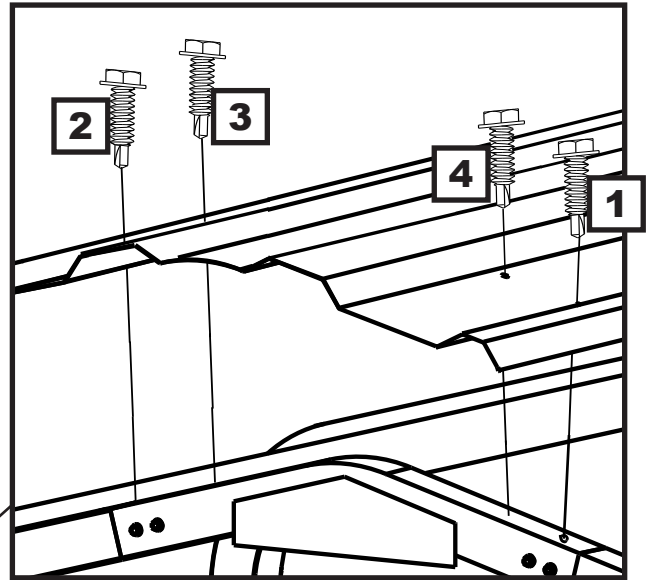
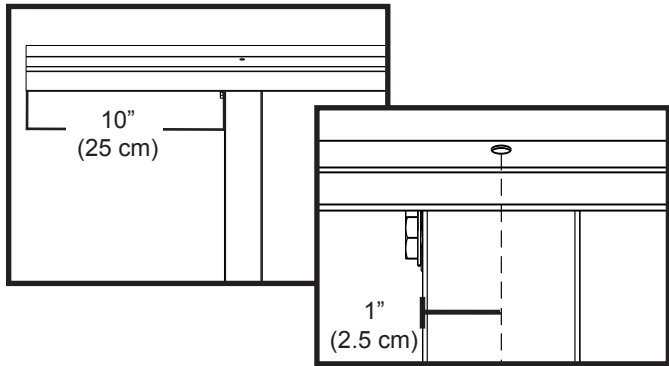
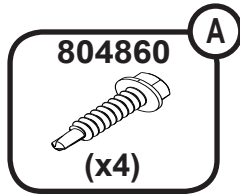
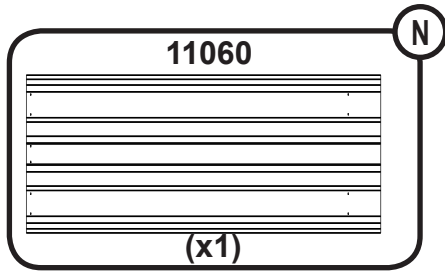

Step 8

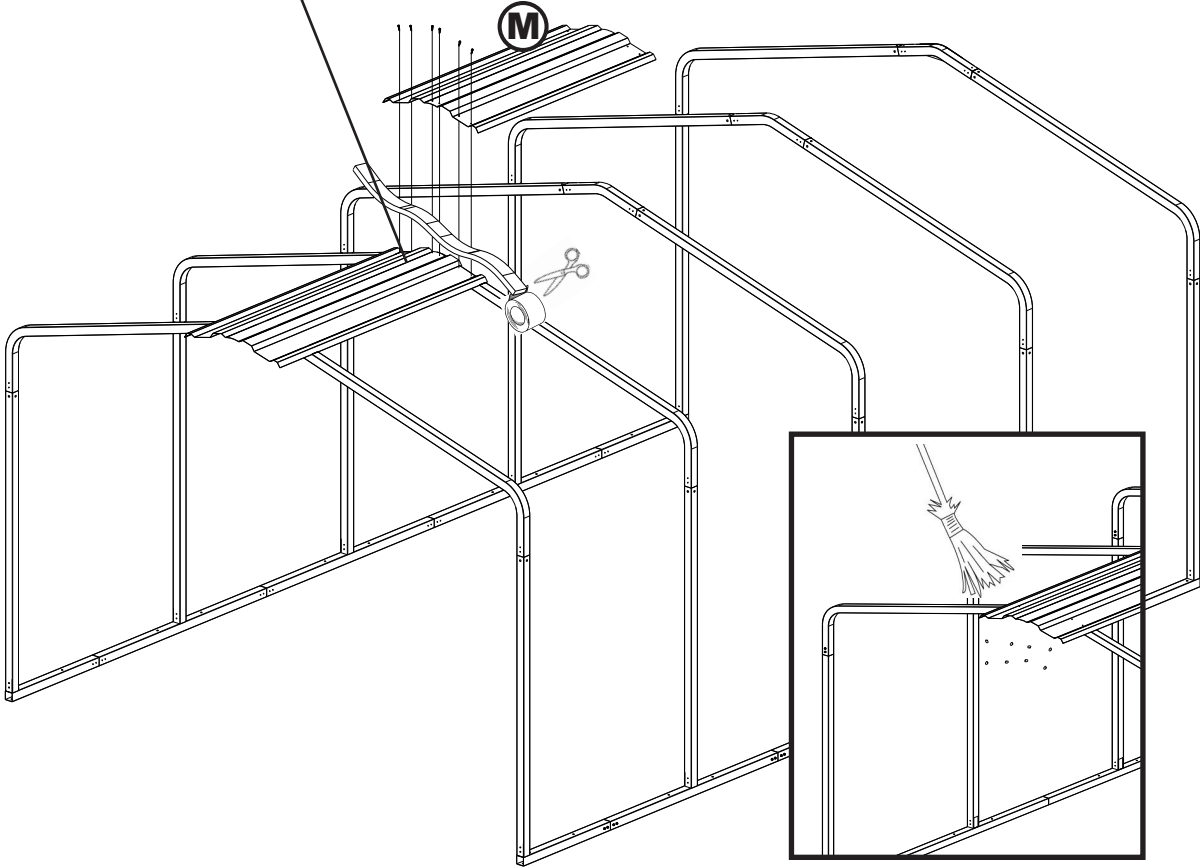
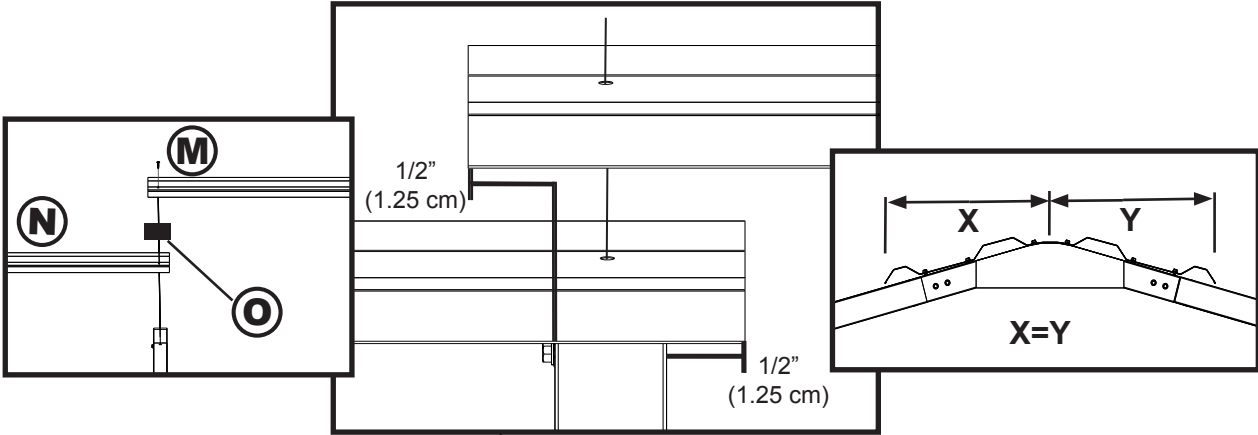
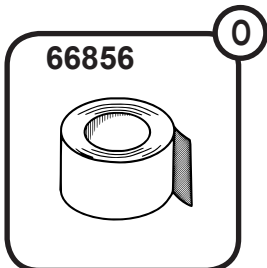
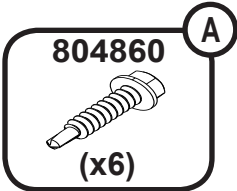
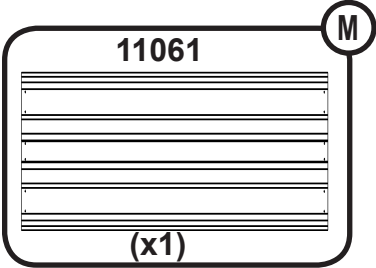

Step 9

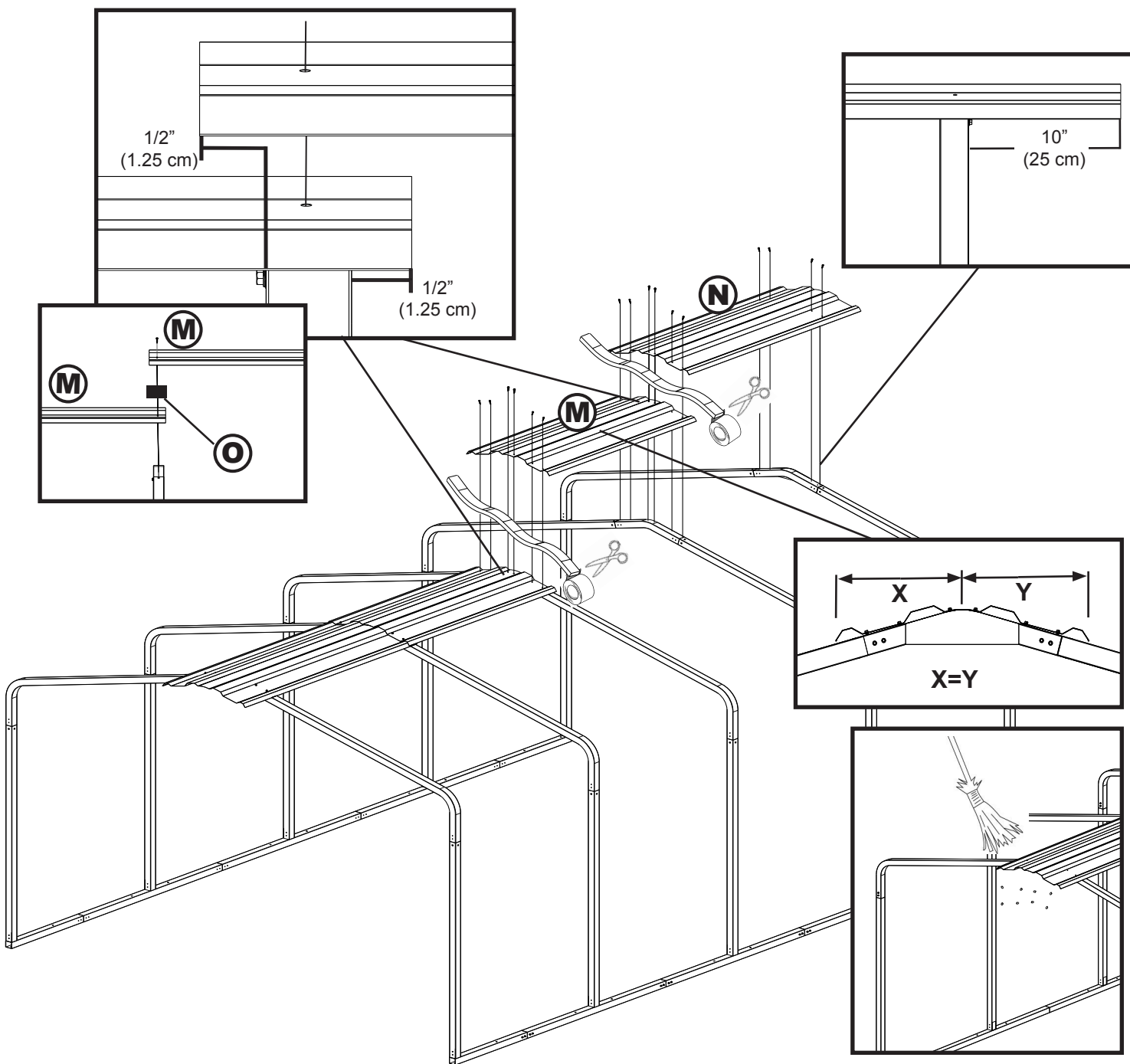
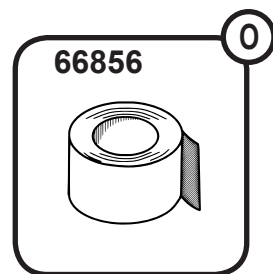
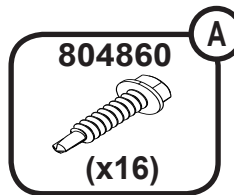
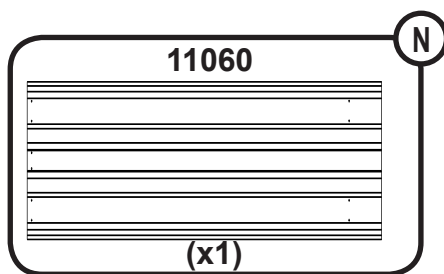
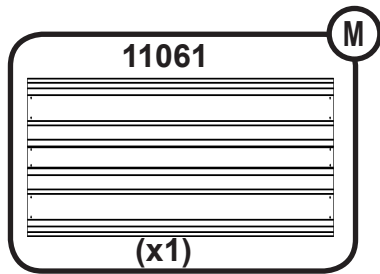

Step 10

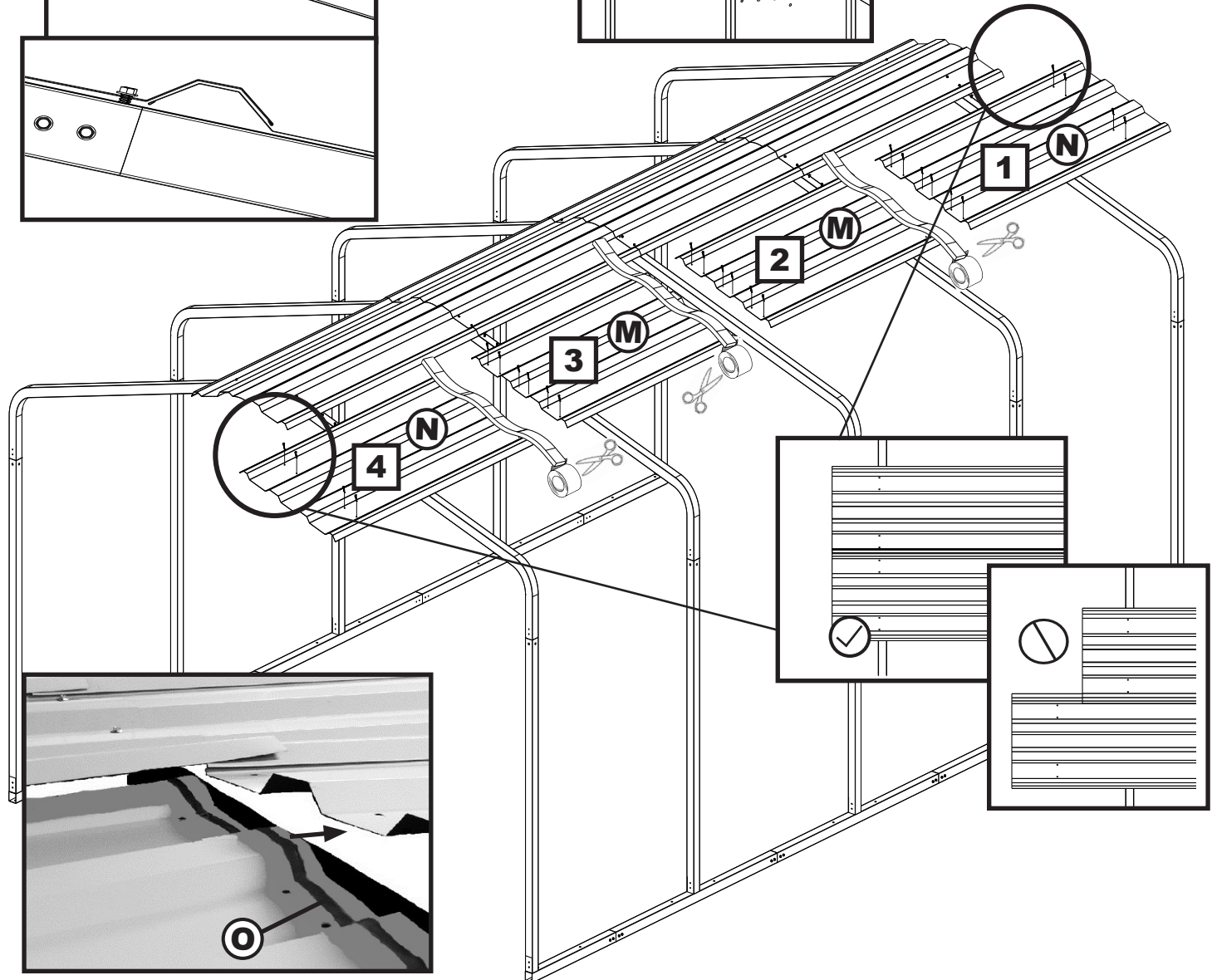
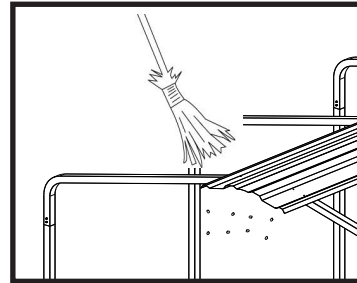
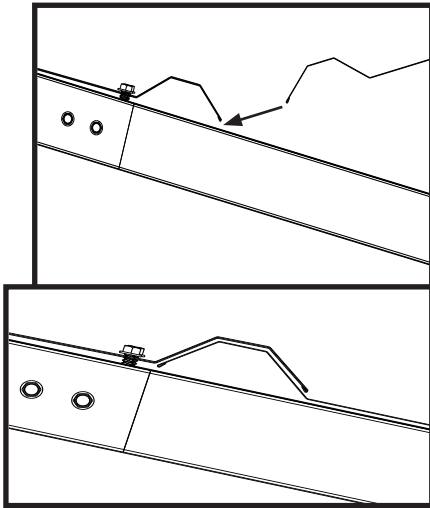
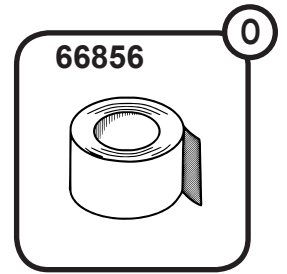
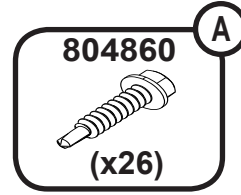
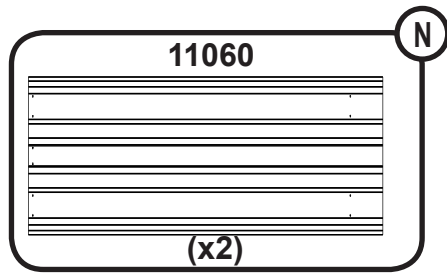
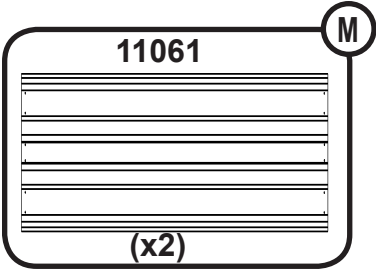

Step 11

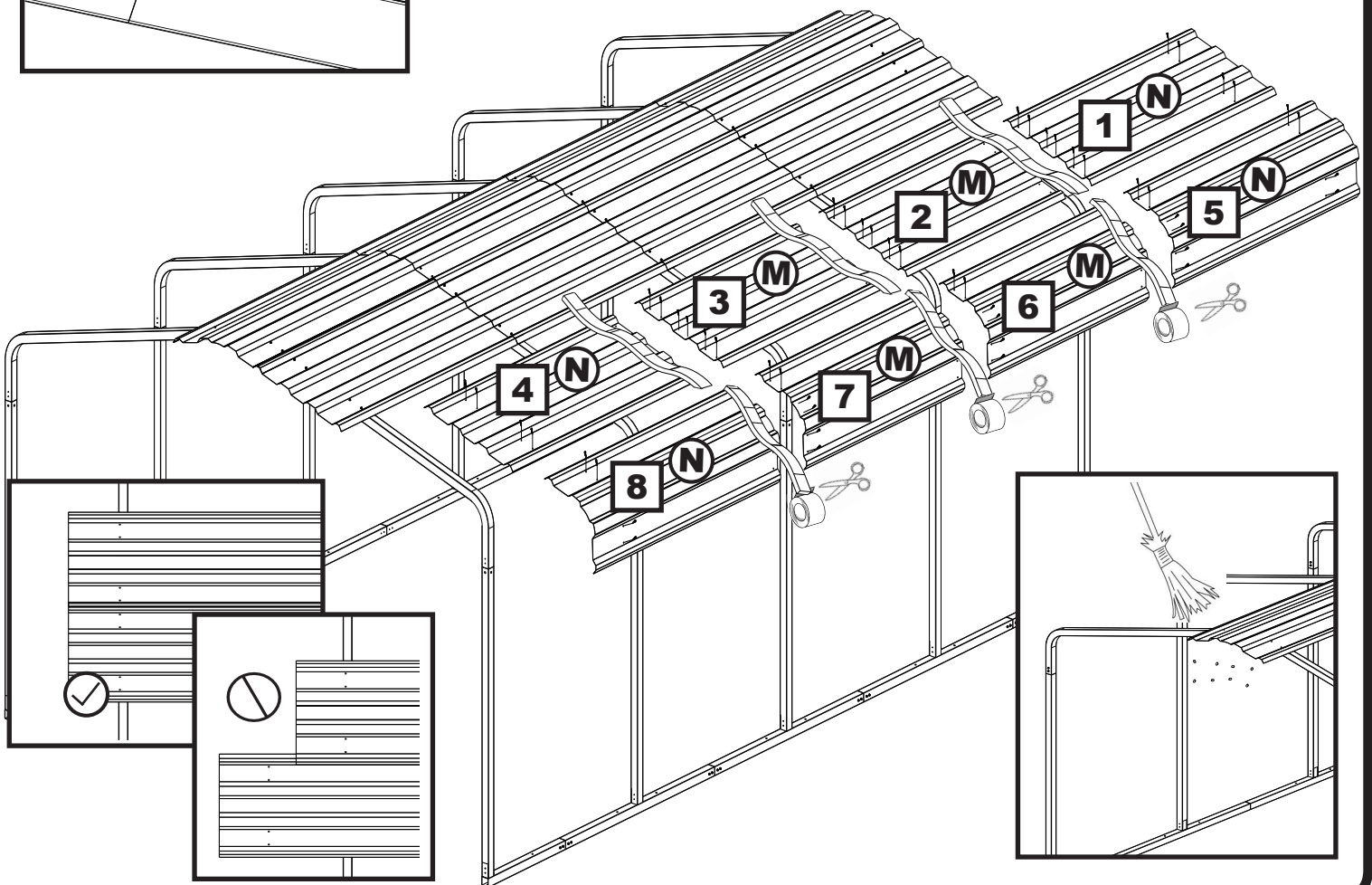
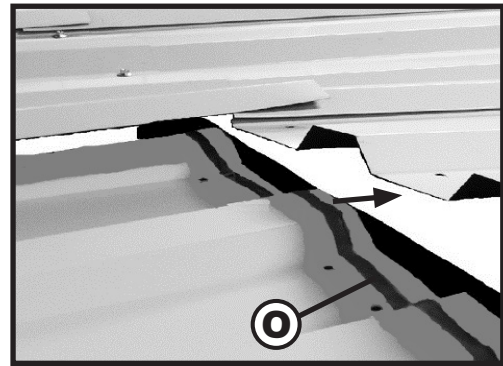
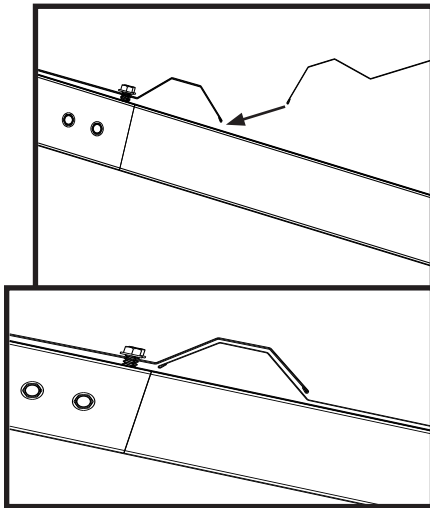
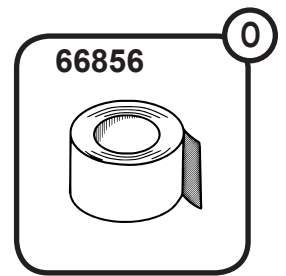
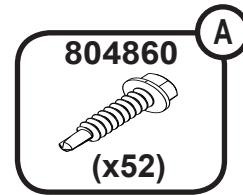
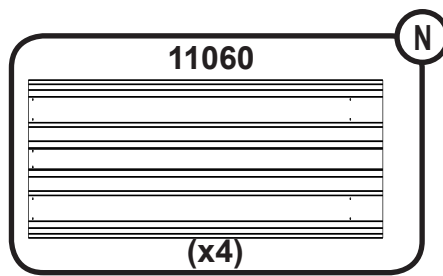
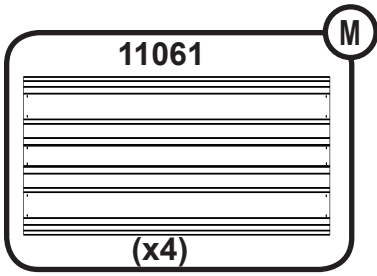

Step 12

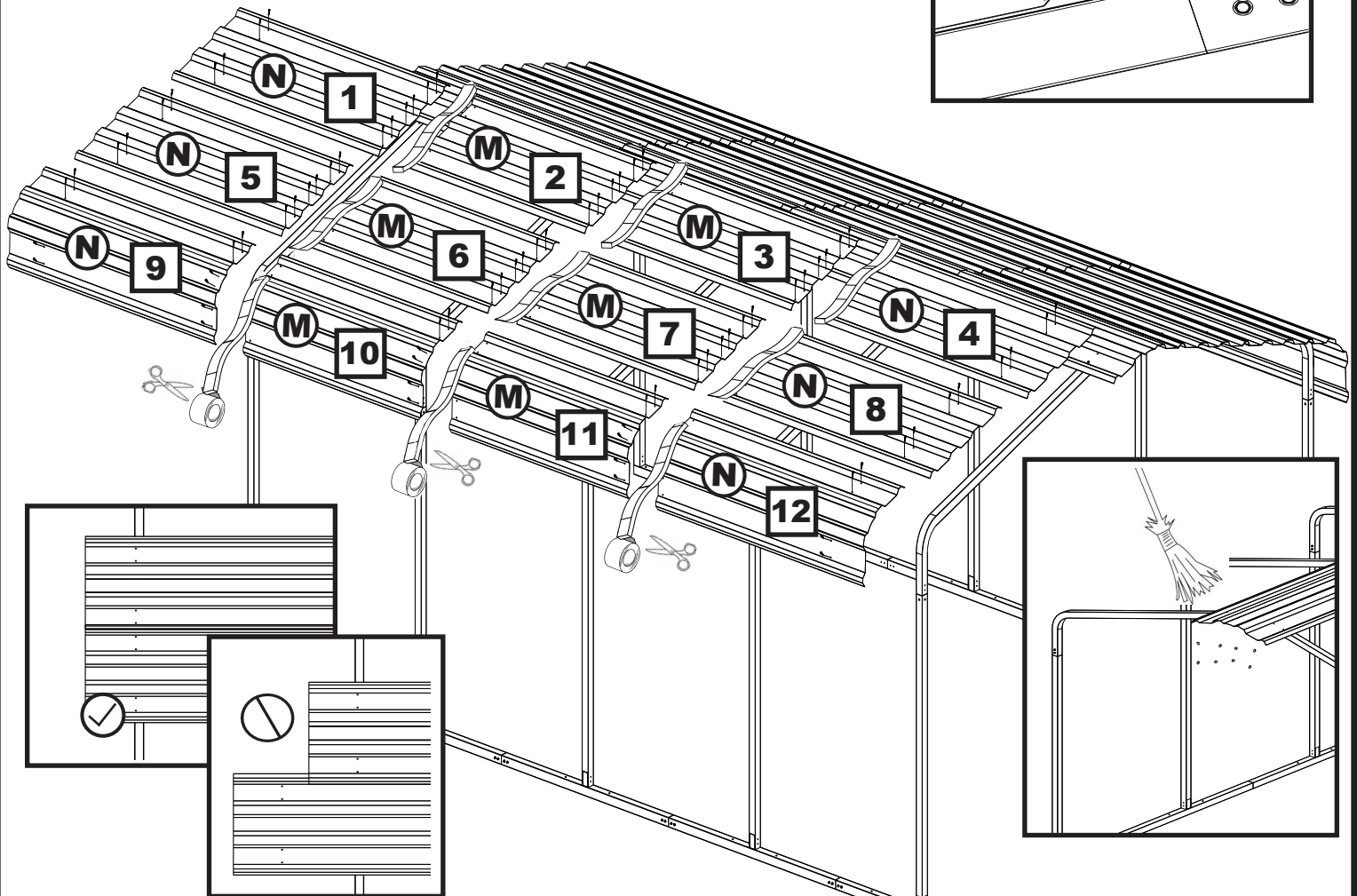
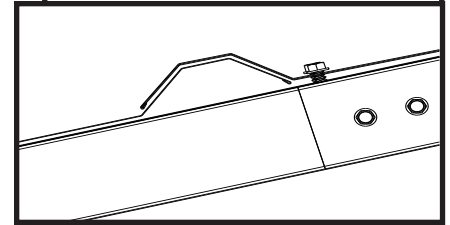
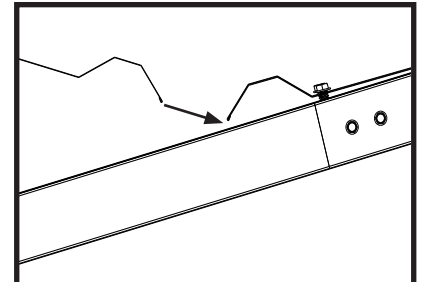
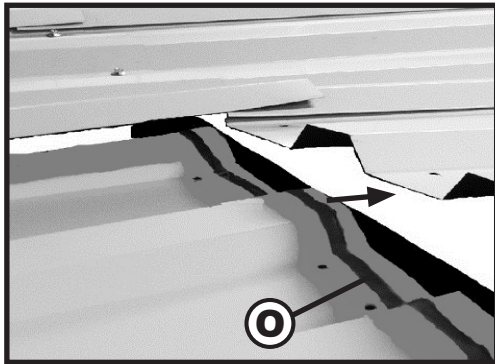
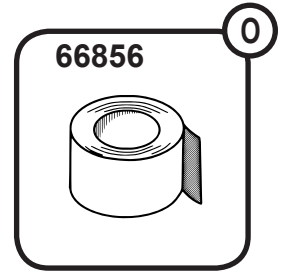
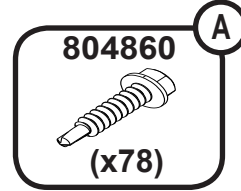
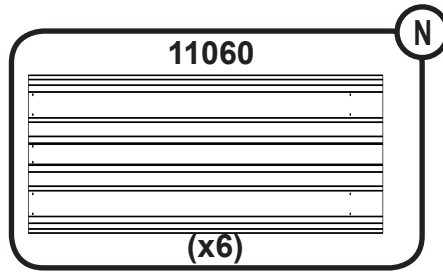
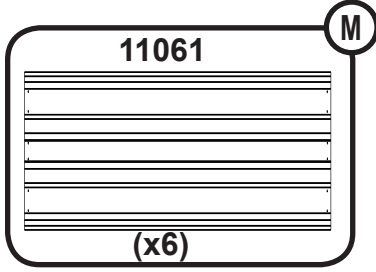

Step 13

