

Parts List

1	Grille guard
1	Driver / left frame mounting bracket
1	Passenger / right frame mounting bracket
2	Spacer plate
1	Driver / left mounting bracket, lower
1	Passenger / right mounting bracket, lower
1	LED support flange
2	Clip nut, M8
2	Hex bolt, M8
2	Flat washer, M8
2	Lock washer, M8
8	Hex bolt, M12 - 1.75mm x 35mm
16	Flat washer, M12 x 32mm OD x 3mm
8	Lock washer, M12
8	Hex nut, M12
2	Plastic retainer, M12

Torque Specifications

	Torque Specifications	
METRIC	M6 bolt	3 ft.-lbs.
	M8 bolt	7 ft.-lbs.
	M10 bolt	16 ft.-lbs.
	M12 bolt	28 ft.-lbs.
SAE	1/4" bolt	3 ft.-lbs.
	5/16" bolt	7 ft.-lbs.
	3/8" bolt	16 ft.-lbs.
	7/16" bolt	20 ft.-lbs.
	1/2" bolt	28 ft.-lbs.

Level of Difficulty

Easy

Product Image



Notes and Maintenance

Before you begin installation, read all instructions thoroughly.

Proper tools will improve the quality of installation and reduce the time required.

For black finishes, mild soap may be used to clean the product.

Refer to the table to the left when securing hardware during the installation process to help prevent damage to the product or vehicle.

Assistance is recommended to avoid possible injury or damage to the vehicle. Cutting is required.

1. Starting at the front-driver side of the front bumper, remove the plastic cover, (if equipped), covering the bumper bolts on both sides of the tow hook, **(Figure 1)**. Remove the (2) outer bumper bolts, **(Figures 2 & 3)**. **IMPORTANT:** Do not remove the inner bumper bolts or the bumper may fall. Only remove the outer bumper bolts. **NOTE:** Cover cannot be reinstalled.
2. Select the driver side Frame Bracket and (1) Spacer Plate, **(Figure 4)**. Place the Spacer over the holes for the bumper bolts. Reuse the factory bumper bolts to attach the Frame Bracket to the Spacer and bumper, **(Figure 5)**. Make sure there is clearance between the top and bottom of the Frame Bracket and the opening in the bumper. Do not tighten hardware at this time.
3. Repeat **Steps 1 & 2** for passenger side Frame Bracket and Spacer installation.
4. Next, remove the plastic air dam from the bottom of the bumper and place it on a clean, stable work surface, **(Figure 6)**. Note the location and type of all factory hardware for reinstallation.
5. From under the driver side of the bumper, locate the (2) outer hex nuts attaching the frame extension to the outside of the frame, **(Figure 7)**. Remove (1) of the (2) factory hex nuts, **(Figures 8 & 9)**. Thread (1) Plastic Retainer onto the threaded end of the double bolt plate inside the frame. Remove the second factory nut from the bolt plate. **NOTE:** The Plastic Retainer is designed to help hold the factory double bolt plate in place in the frame and to help with bracket installation. Do not allow the double bolt plate to fall into the frame channel.
6. Select the driver side Lower Mounting Bracket. Reuse the (2) factory hex nuts to attach the Bracket to the double bolt plate, **(Figure 10)**. Do not tighten hardware at this time.
7. Repeat **Steps 5 & 6** for passenger side Lower Mounting Bracket installation.
8. To install an LED light into the light bar cage, select an LED light, mounting hardware and brackets. Attach the hardware to the support flange (Figure 11).
9. Place a clip nut on both ends of the support flange. Insert an 8mm hex bolt, lock washer and flat washer into the clip nut. Leave enough space between the flat washer and clip nut to slot the support flange into the light bar cage on the grille guard (Figure 12).
10. Place the grille guard face down on a flat, stable work surface. Insert the support flange into the light bar cage and ensure the flat washer, lock washer and head of the hex bolt are on the outside of the center flange. Tighten the support flange to the light bar cage (Figure 13).
11. With assistance, position the Grille Guard up to the outside of the Mounting Brackets. Attach the Grille Guard to the Frame Brackets with the included (4) 12mm x 35mm Hex Bolts, (8) 12mm Flat Washers, (4) 12mm Lock Washers and (4) 12mm Hex Nuts, **(Figure 11)**. Do not fully tighten hardware.
12. Attach the Grille Guard to the Lower Mounting Brackets with the included (4) 12mm x 35mm Hex Bolts, (8) 12mm Flat Washers, (4) 12mm Lock Washers and (4) 12mm Hex Nuts, **(Figure 11)**. Do not tighten hardware at this time.
13. Level and adjust the Grille Guard and fully tighten the Bracket to vehicle hardware only at this time. Temporarily remove the Grille Guard.

14. Hold the plastic air dam up in position against the Lower Brackets and mark the location of the Brackets onto the top of the air dam, **(Figure 12)**. Measure the location of the Lower Brackets and transfer these measurements onto the back of the air dam, **(Figures 13 & 14)**. Place the air dam back up to the (2) Lower Mounting Brackets to verify location before cutting. Check all measurements on the vehicle. Once absolutely satisfied, use a hacksaw blade or utility knife to carefully cut (2) openings in air dam. Check fit, trim as necessary and reuse the factory hardware to reinstall air dam over Lower Brackets. **IMPORTANT:** On the "tall" air dam only, do not cut through the top or bottom edge of the air dam, **(Figure 13)**. **NOTE:** It may be necessary to loosen or temporarily remove the Lower Mounting Brackets only to reinstall the air dam.
15. Reinstall the Lower Brackets through the air dam if removed.
16. Reinstall the Grille Guard as described in **Steps 8 & 9**. Level and adjust Grille Guard and fully tighten all hardware. Reinstall the license plate and bracket.
17. Do periodic inspections to the installation to make sure that all hardware is secure and tight.

Driver/left Side Installation Pictured

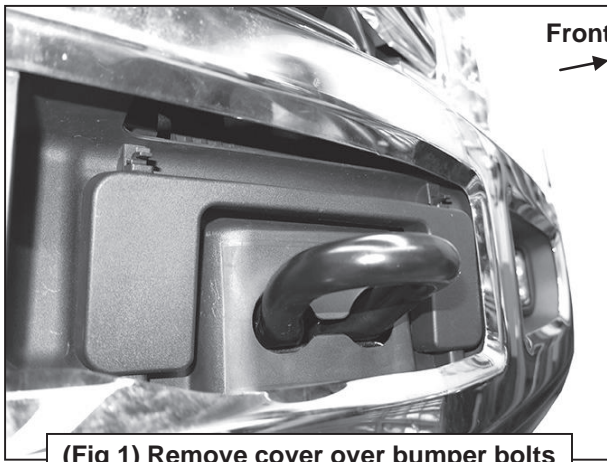

(Fig 1) Remove cover over bumper bolts

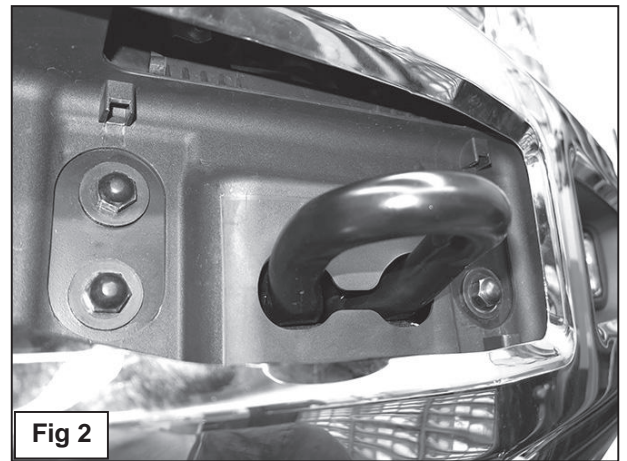
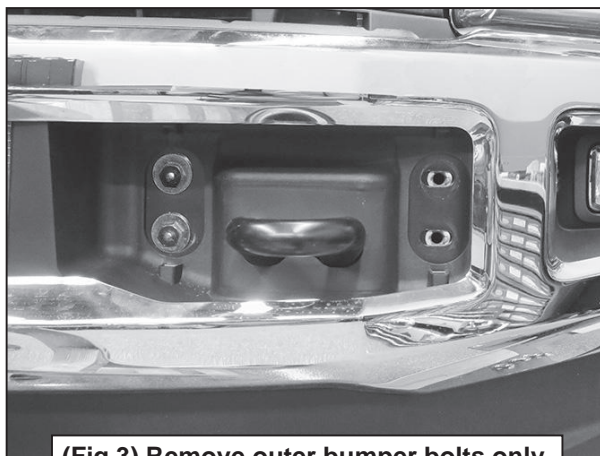
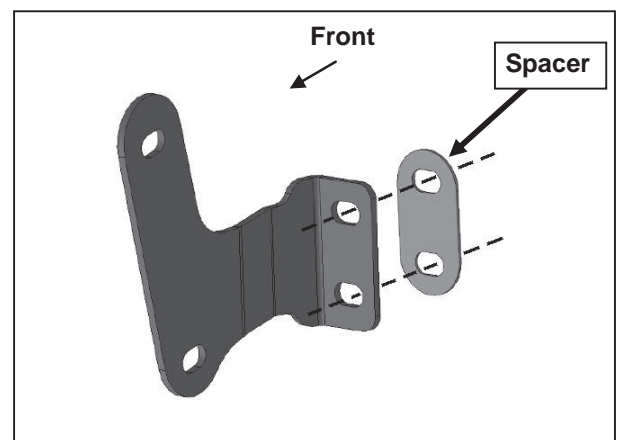

Fig 2



(Fig 3) Remove outer bumper bolts only



(Fig 4) Reuse factory bumper bolts to attach driver/left Frame Bracket to Spacer and bumper. Do not install Bracket without Spacer

Driver/left Side Installation Pictured

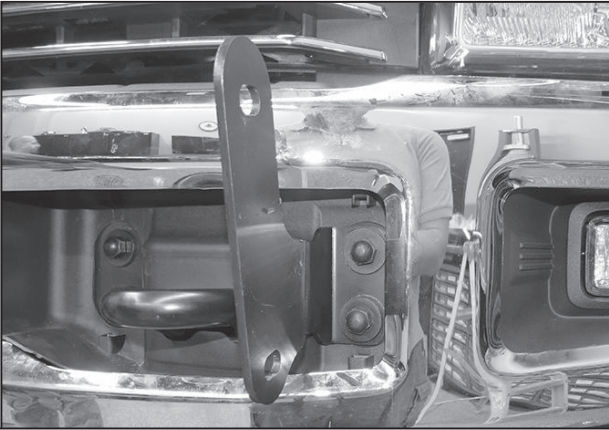

(Fig 5) Reuse factory bumper bolts to attach driver/left Frame Bracket to Spacer and bumper



(Fig 6) Remove plastic air dam from bumper

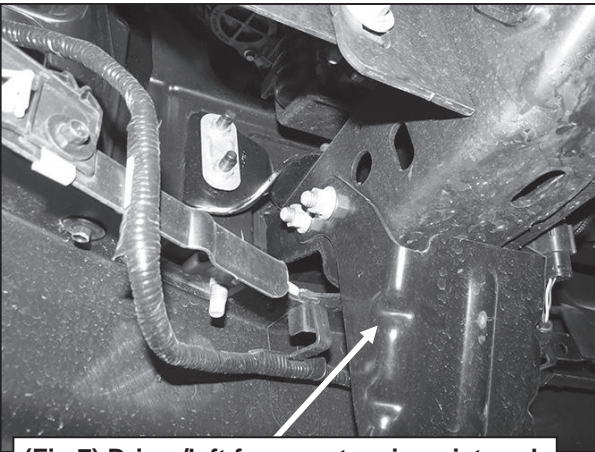

(Fig 7) Driver/left frame extension pictured

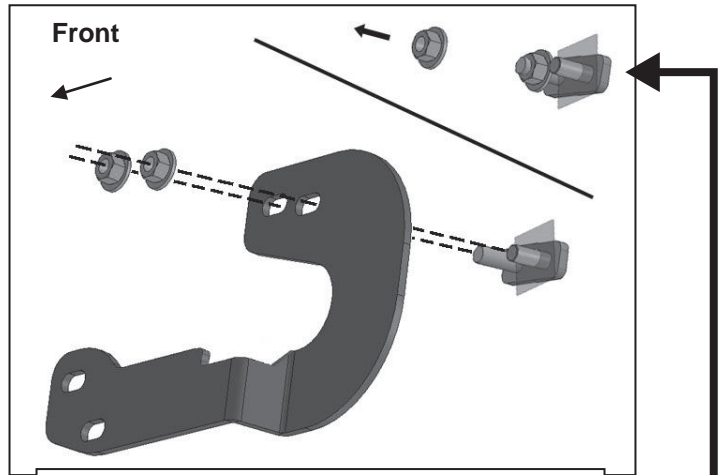

(Fig 8) Driver/left Lower Bracket illustrated. Reuse factory hardware to attach Bracket to side of frame and frame extension

Remove (1) nut, thread (1) 12mm Plastic Retainer onto threaded end before removing remaining hex nut

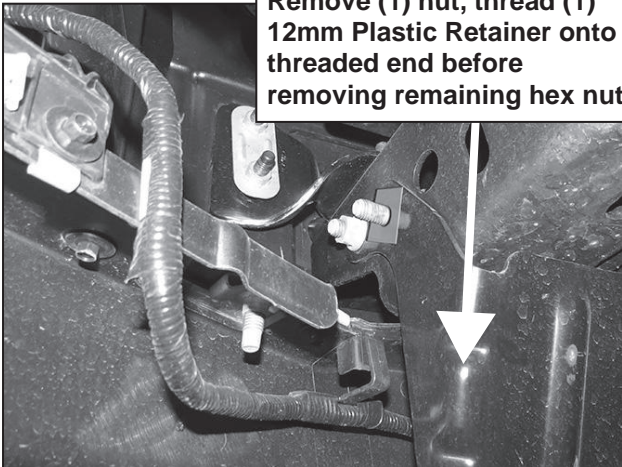

(Fig 9) Driver/left frame extension pictured

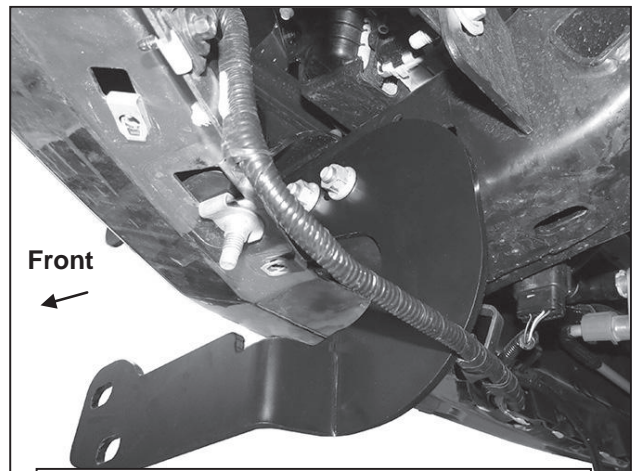

(Fig 10) Driver/left Lower Bracket pictured. Reuse factory hardware to attach Bracket to side of frame and frame extension



(Fig 11) LED installed on support flange



(Fig 12) Insert an 8mm clip nut over the end of the support flange and insert an 8mm hex bolt

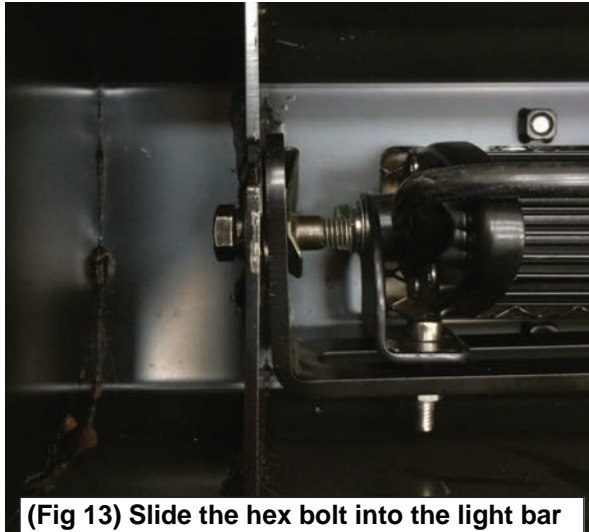

(Fig 13) Slide the hex bolt into the light bar cage and tighten

