









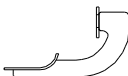

INSTALLATION INSTRUCTION
 For Ford F150 Regular/Super Cab 97-04
 ITEM NO:4506

ATTENTION

1. Please read this installation instruction before installing this part.
 When install it, please pay attention to protecting your vehicles.

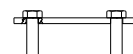
2. When you use it, please check this parts at a fix time-lapse, such as one month or two month.

PARTS LIST

No	Name	Photo	Qty	Remarks	No	Name	Photo	Qty	Remarks
①	Mount Bracket		2		⑧	"T"Bolt		4	
②	Mount Bracket		2		⑨	flat washer		16	M6
③	"T"Bolt		4	M10	⑩	LOCK NUT		16	M6
④	"T"Bolt		2	M10					
⑤	Flat Washer		12	M10					
⑥	Lock Washer		12	M10					
⑦	Hex Nut		12	M10					

Installation Diagram

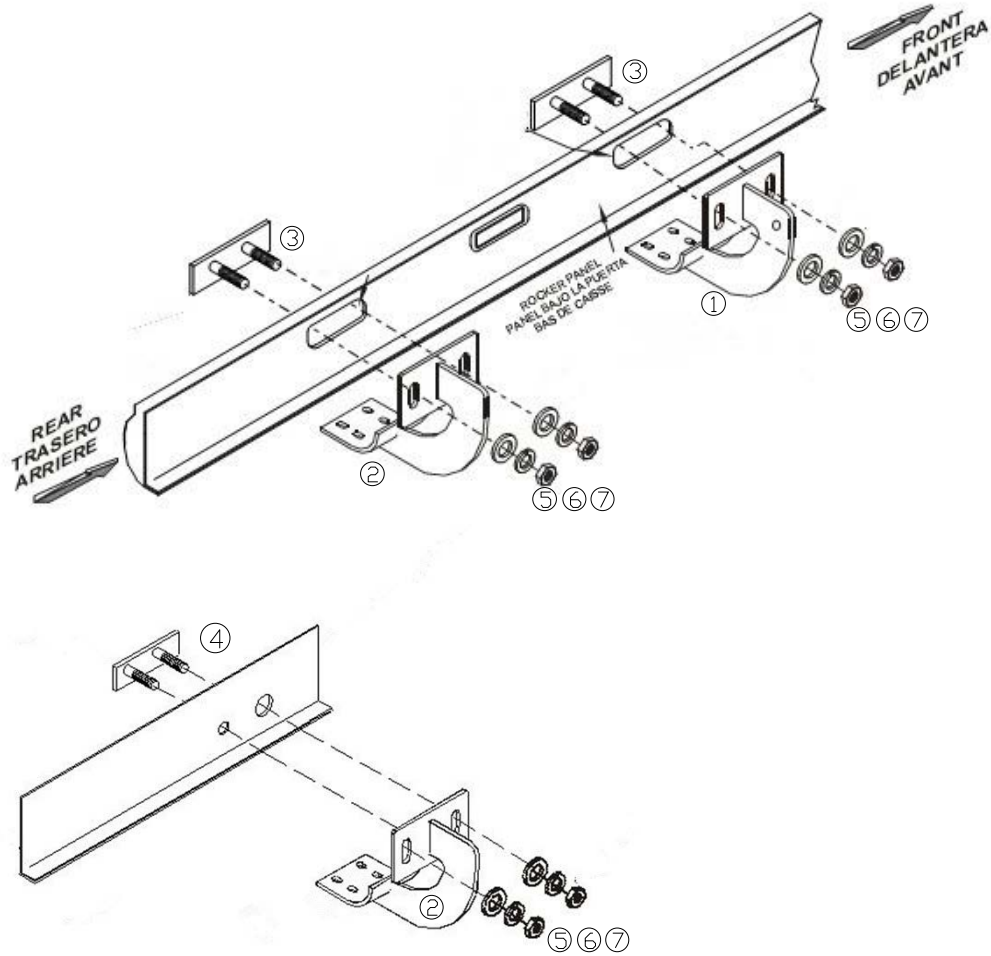

STEP-1

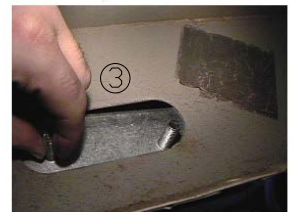

STEP-2



STEP-3



STEP-4

INSTALLATION STEPS

STEP 1: Check the parts in the box carefully if match above list .

STEP 2: Pls prepare the tools for installation, follow as: 10-12wrench, 14-17 wrench .

STEP 3: Put the mount bracket into the girder of the car, and tighten it with "T" Bolt ③④.

STEP 4: Install the Side Bar to the mount bracket, and tighten it with T" Bolt ③.

STEP 5: Installation is finished.

Rely on premium off-road bumpers by Aries if you' re looking for quality and efficiency.