



INSTALLATION INSTRUCTION











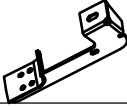



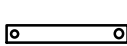

ITEM NO:4492

APPLICATION: 99-13 Chevy Silverado 1500/2500/3500 - Reg.Cab

ATTENTION

1. Please read this installation instruction before installing this part. When install it, please pay attention to protecting your vehicles.
2. When you use it, please check this parts at a fix time-lapse, such as one month or two month.

PARTS LIST

No	Name	Photo	Qty	Remarks	No	Name	Photo	Qty	Remarks
①	Mount bracket 1		4	Lateral symmetry	⑩	Hex Bolt		6	M10x35
②	Mount bracket 2		2	Lateral symmetry	⑪	Lock washer		6	M10
③	Mount bracket 3		2		⑫	Flat washer		6	M10
④	Mount bracket 4		2		⑬	Hex nut		6	M10
⑤	Hex Bolt		4	M12*50 Teeth long:30	⑭	"T"Bolt		4	
⑥	Hex Bolt		2	M12*50	⑮	Flat washer		16	M6
⑦	Lock washer		6	M12	⑯	LOCK NUT		16	M6
⑧	Flat washer		6	M12					
⑨	Hex nut		6	M12					

Driver Side Installation Pictured

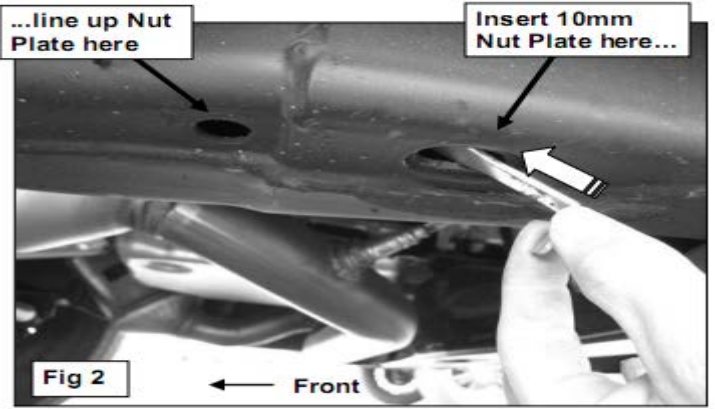

10mm Nut Plate
10mm x 30mm Hex Bolt
10mm Lock Washer
10mm Flat Washer

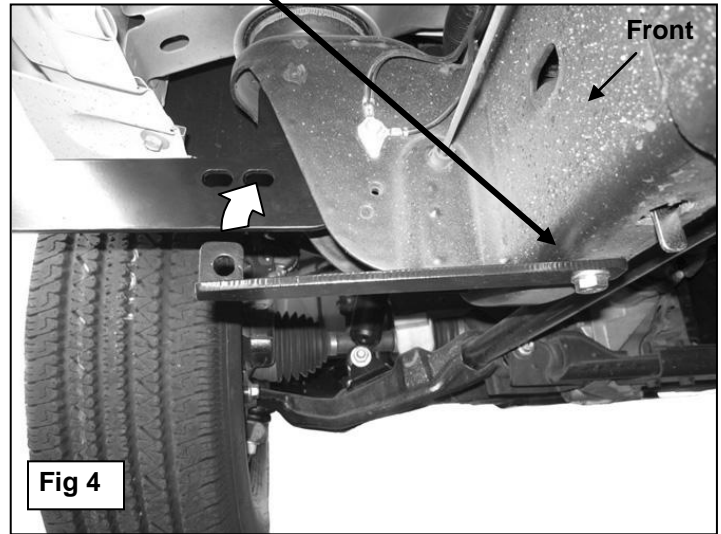

IMPORTANT NOTE: 25-3500 Model Front Support Bracket Installation Pictured Bend Support Bracket up by hand to meet the Front Mounting Bracket.

NOTE: Support Brackets not required on 2011 25-3500 Models

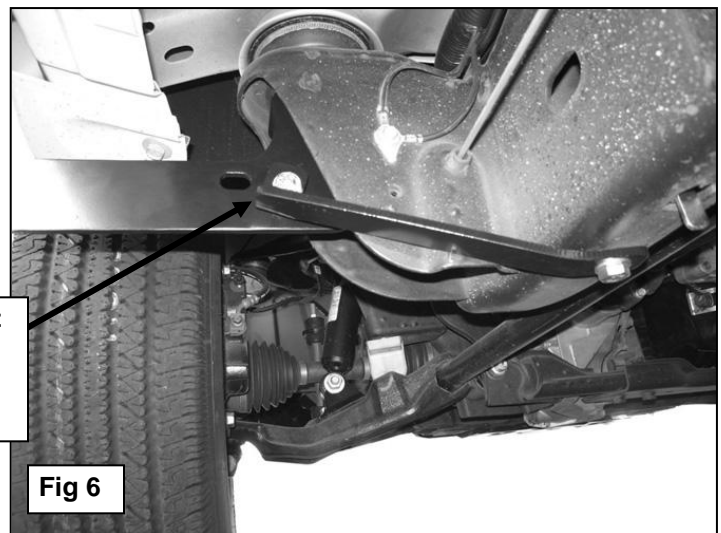
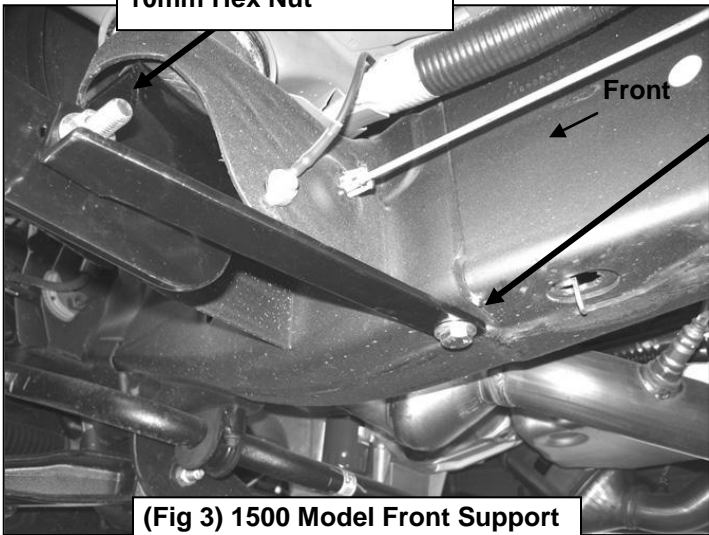

Fig 6

10mm x 30mm Hex Bolt
(2) 10mm Flat Washers
10mm Lock Washer
10mm Hex Nut



(Fig 3) 1500 Model Front Support Bracket Installation Pictured



Fig 5

10mm x 30mm Hex Bolt
(2) 10mm Flat Washers
10mm Lock Washer
10mm Hex Nut

NOTE: Support Brackets not required on 2011 25-3500 Models

Driver Side Installation Pictured

12mm x 30mm Hex Bolt
(2) 12mm Flat Washers
12mm Lock Washer
12mm Hex Nut

NOTE: Support Brackets not required on 2011 25-3500 Models

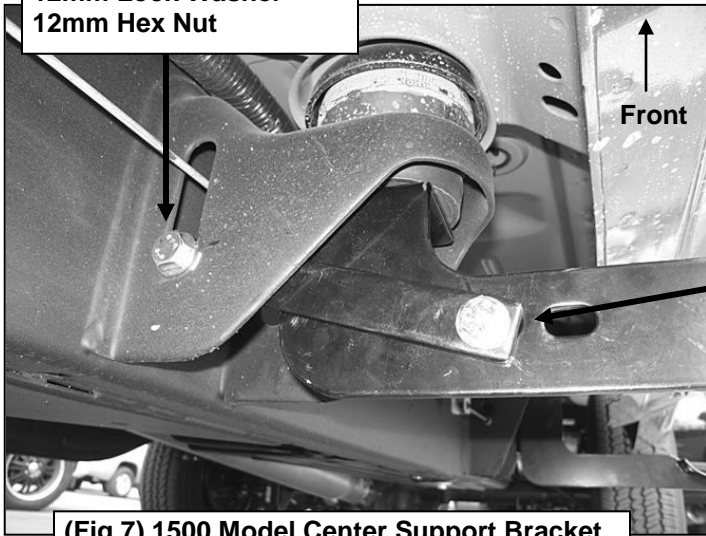

(Fig 7) 1500 Model Center Support Bracket Installation Pictured

10mm x 30mm Hex Bolt
(2) 10mm Flat Washers
10mm Lock Washer
10mm Hex Nut

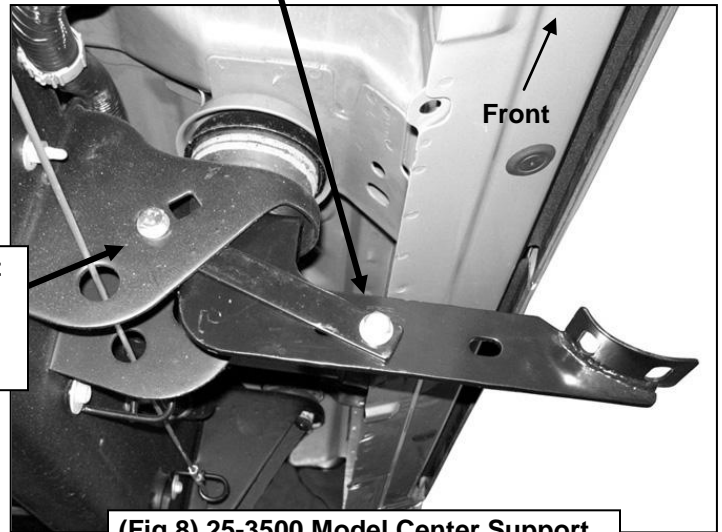

(Fig 8) 25-3500 Model Center Support Bracket Installation Pictured.

12mm x 30mm Hex Bolt
(2) 12mm Flat Washers
12mm Lock Washer
12mm Hex Nut

NOTE: Support Bracket not required on 2011 25-3500 Models

