



INSTALLATION INSTRUCTIONS

2007-10 SILVERADO 1500 TON / 2007-10 SIERRA 1500 TON

PART # B35-4005 / 35-4005

PARTS LIST:

| | | | |
|---|----------------------------------|---|---------------------------------------|
| 1 | Bull Bar | 3 | 12mm Lock Washers |
| 1 | Driver/Left Mounting Bracket | 5 | 12m ID x 29mm OD x 3mm Flat Washers |
| 1 | Passenger/Right Mounting Bracket | 3 | 12mm Hex Nuts |
| 1 | 12-1.75mm x 35mm Bolt Plate | 4 | 8-1.25mm x 30mm Hex Head Bolts |
| 2 | Tube Spacers – 84mm | 4 | 8mm Lock Washers |
| 2 | 12-1.75mm x 140mm Hex Head Bolts | 4 | 8mm ID x 17mm OD x 1.5mm Flat Washers |

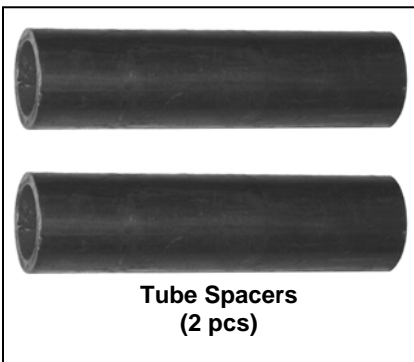
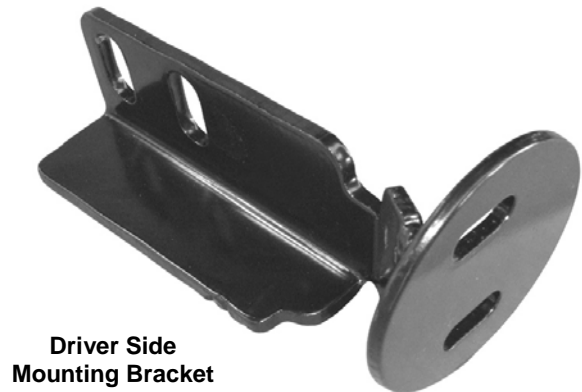
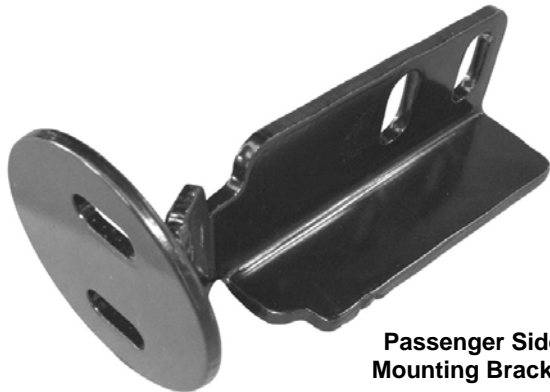

PROCEDURE:

1. **REMOVE CONTENTS FROM BOX. VERIFY ALL PARTS ARE PRESENT. READ INSTRUCTIONS CAREFULLY BEFORE STARTING INSTALLATION.**
2. **NOTE:** It may be necessary to remove/relocate front license plate and license plate bracket. It is not required, but strongly recommended. If local/state law requires a license plate, license plate relocation kit is available.
3. From underside of vehicle, remove the two bolts holding the driver factory tow hook, then remove tow hook from vehicle. **NOTE:** This Bull Bar is not compatible with factory tow hooks, so you will not be reinstalling factory tow hooks back onto vehicle.
4. Loosely attach Mounting Brackets to Bull Bar using the included (4) 8mm x 30mm Hex Head Bolts, (4) 8mm Lock Washers, and (4) 8mm Flat Washers (**Figure 1**). Do not tighten at this time. **NOTE:** Refer to figure above for bracket configuration.
5. With help slide the Bull Bar assembly through tow hook cavities and place Mounting Brackets on the outer side of frame rails.
6. **On the driver side** you will be using the front tow hook hole that traverses the frame from side to side to attach Mounting Bracket to frame rail. Insert (1) Tube Spacers through the front of frame rail and align it with hole that traverses the frame rail (**Figure 2**). Secure the assembly with the included (1) 12mm x 140mm Hex Head Bolt, (1) 12mm Lock Washer, (1) 12mm Hex Nut, and (2) 12mm Flat Washers (**Figure 3**).
7. **On the passenger side** use the included (1) 12mm x 35mm Bolt Plate, (1) 12mm Lock Washer, (1) 12mm Hex Nut, and (1) 12mm Flat Washer to attach Mounting Bracket to rear tow hook hole. Repeat step 6 to attach Mounting Bracket to front tow hook hole (**Figure 4**).
8. Adjust Bull Bar properly, and then tighten all hardware at this time. **NOTE:** If you can't reach the Bull Bar Bolts (8mm hardware) from behind of bumper and through tow hook cavity, some cutting might be necessary to the tow hook cavity in order to tighten the Bull Bar Bolts.
9. Do periodic inspections to the installation to make sure that all hardware is secure and tight.

To protect your investment, wax this product after installing. Regular waxing is recommended to add a protective layer over the finish. Do not use any type of polish or wax that may contain abrasives that could damage the finish.

For stainless steel: Aluminum polish may be used to polish small scratches and scuffs on the finish. Mild soap may be used also to clean the Bull Bar.

For gloss black finishes: Mild soap may be used to clean the Bull Bar.

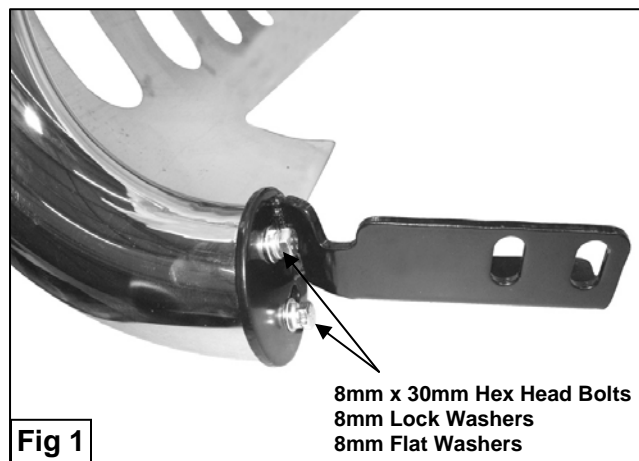

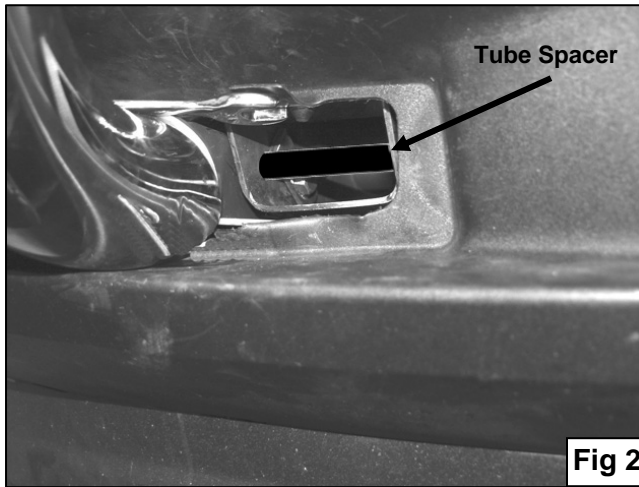

Inner Side of Driver Frame Rail Shown

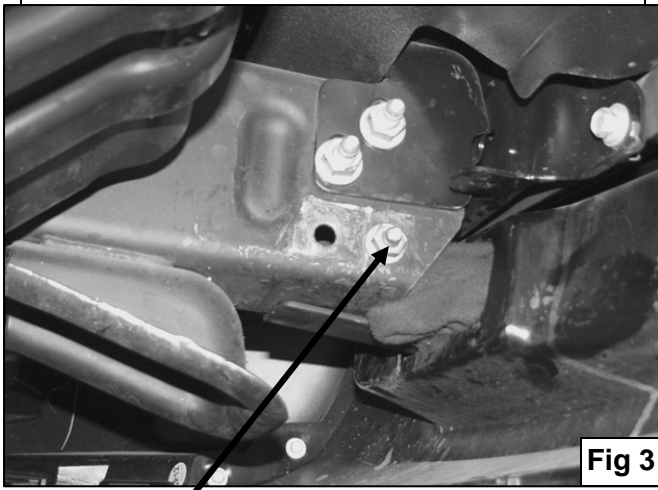

Factory Hardware or
12mm x 140mm Hex Head Bolt
12mm Lock Washer
12mm Hex Nut
12mm Flat Washers

Outer Side of Passenger Frame Rail Shown

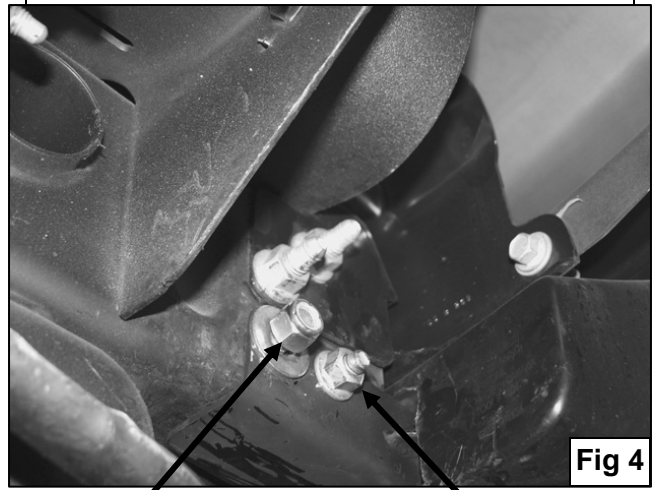

12mm Bolt Plate
12mm Lock Washer
12mm Hex Nut
12mm Flat Washer

Factory Hardware or
12mm x 140mm Hex Head Bolt
12mm Lock Washer
12mm Hex Nut
12mm Flat Washers

