



INSTALLATION INSTRUCTIONS

**GRILL GUARD PART #2063-2/2063
2010 TOYOTA 4RUNNER**

PARTS LIST:

1	Grille Guard	4	12mm Hex Nuts
1	Driver/Left Frame Mounting Bracket	2	8-1.25mm x 30mm Button Head Bolts
1	Passenger/Right Frame Mounting Bracket	2	8-1.25mm x 30mm Hex Bolts
2	Top Mounting Brackets	6	8mm x 24mm OD x 2mm Flat Washers
4	12-1.75mm x 30mm Hex Bolts	2	8mm x 16mm OD x 1.6mm Flat Washers
8	12mm ID x 24mm OD x 2.5mm Flat Washers	4	8mm Nylon Lock Nuts
4	12mm Lock Washers	1	50mm x 200mm Adhesive Backed Foam Tape

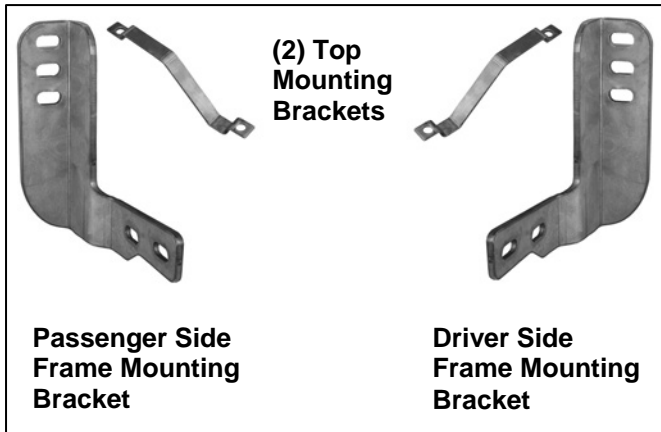

PROCEDURE:

- 1. REMOVE CONTENTS FROM BOX. VERIFY ALL PARTS ARE PRESENT. READ INSTRUCTIONS CAREFULLY BEFORE STARTING INSTALLATION. ASSISTANCE IS RECOMMENDED. CUTTING IS REQUIRED.**
- Remove the driver side and passenger side plastic splash guards and place them on a clean, stable work area, **(Figure 1)**. To make reinstallation easier, note the type and location of all factory fasteners. The plastic center splash guard may also be removed for better access to hardware if necessary. **IMPORTANT:** As an added precaution, apply a layer of masking tape to the openings in the bumper to protect the painted finish during bracket installation, **(Figure 2)**.
- Starting on the driver side, remove the (3) factory bumper mount bolts located toward the outside of the bumper mount, **(Figure 3)**. Select the driver side frame mounting bracket and hold it in a horizontal position, **(Figure 4)**. Insert the mounting tab on the Bracket into the back of the grille opening and rotate the Mounting Bracket up to the bumper bolts. Line up the (3) slots in the Mounting Bracket with the (3) bolt locations for the factory bumper bracket. Secure the Frame Mounting Bracket to the factory bumper bracket using the (3) factory bolts removed earlier, **(Figure 5)**. Snug but do not tighten hardware at this time. Repeat this Step for passenger side Frame Mounting Bracket installation.
- Next, open the hood and remove the plastic cover between the top of the radiator and the grille. **NOTE:** Pay close attention to the type and location of all factory hardware for easier reinstallation.

5. Select (2) Top Brackets and apply the Adhesive Backed Foam Tape to the underside (side facing the bumper) to prevent damage to the bumper cover during installation. **NOTE:** Cut Foam Tape to fit and only apply to areas that may come in contact with bumper cover, **(Figure 8)**.
6. Remove the (2) plastic clips securing the bottom of the grille insert to the crossmember, **(Figure 6 & 7)**. Select (1) Top Bracket and from behind the grille, insert the Bracket through the opening in the grille insert, **(Figure 8)**. Line up the hole in the Top Bracket with the tab on the crossmember and secure with (1) 8mm x 30mm Hex Bolt, (2) 8mm x 24mm x 2mm Flat Washers and (1) 8mm Nylon Lock Nut, **(Figure 9)**. Leave hardware loose. Repeat this step for passenger side Top Bracket installation.
7. With assistance, line up the bottom mounting tabs on the Grille Guard with the (2) previously installed Frame Mounting Brackets. Bolt the Grille Guard to the Frame Mounting Brackets with the included (4) 12mm x 30mm Hex Bolts, (8) 12mm Flat Washers, (4) 12mm Lock Washers and (4) 12mm Hex Nuts, **(Figure 10)**. Do not tighten hardware at this time.
8. Push the Grille Guard back toward the vehicle and line up the (2) Top Mounting Brackets with the holes in the crossbar. **NOTE:** The Top Mounting Brackets bolt to the bottom of the crossbar on the Grille Guard. Loosen or remove the previously installed (2) 8mm Hex Bolts if necessary to move the Top Brackets into the proper position. Once lined up, attach the Top Brackets to the bottom of the crossbar on the Grille Guard with the included (2) 8mm Button Head Bolts, (2) 8mm x 16mm Small Flat Washers (top), (2) 8mm x 24mm Flat Washers (bottom) and (2) 8mm Nylon Lock Nuts, **(Figure 11)**. Do not tighten hardware at this time.
9. Level and adjust the Grille Guard properly and tighten all hardware. **IMPORTANT:** Do not over-tighten the (2) 8mm Hex Bolts attaching the Top Mounting Brackets to the grille insert and crossmember or you may damage the plastic grille insert.
10. Reinstall the plastic center splash guard using the factory hardware.
11. Select the driver side plastic splash guard and hold it up in position against the Frame Mounting Bracket, **(Figure 1 & 12)**. Mark the area that needs to be removed from the splash guard to clear the Mounting Bracket. Check the location carefully and cut only the minimum amount of plastic from the splash guard to clear the Bracket, **(Figure 13)**. Once the slot has been checked for clearance, reinstall the splash guard with the factory hardware. Repeat this step to reinstall the passenger side splash guard.
12. Do periodic inspections to the installation to make sure that all hardware is secure and tight.

To protect your investment, wax this product after installing. Regular waxing is recommended to add a protective layer over the finish. Do not use any type of polish or wax that may contain abrasives that could damage the finish.

For stainless steel: Aluminum polish may be used to polish small scratches and scuffs on the finish. Mild soap may be used also to clean the Grille Guard.

For gloss black finishes: Mild soap may be used to clean the Grille Guard.

Driver Side Installation Pictured

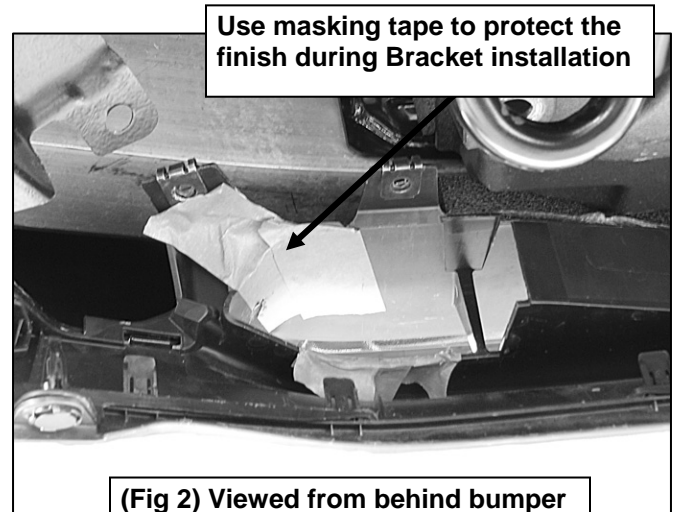
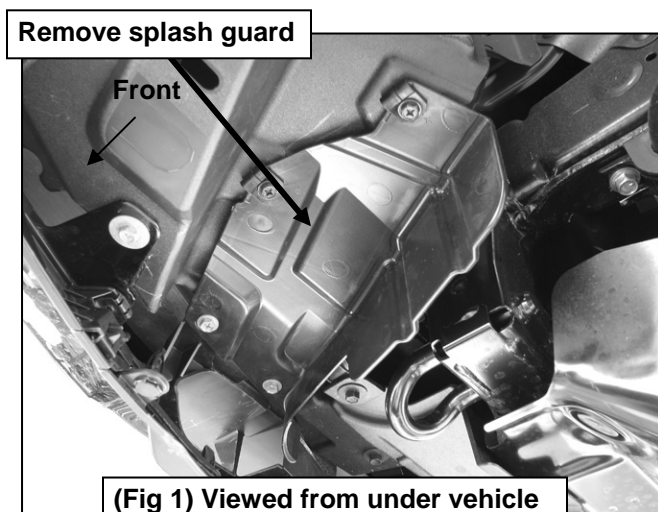

Driver Side Installation Pictured

Remove (3) factory bumper bracket bolts (outer bolts only)

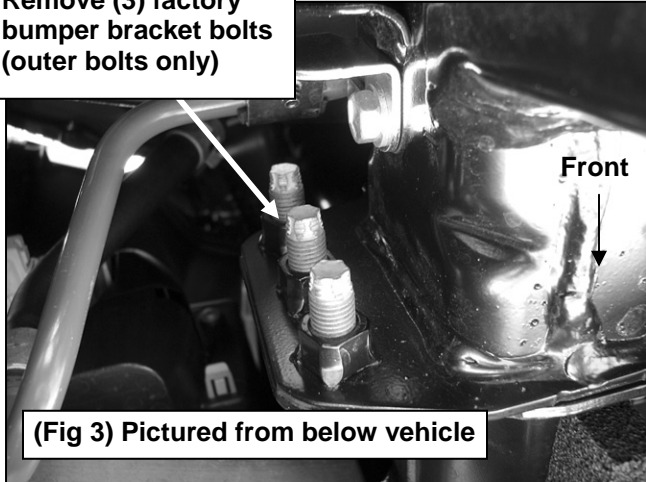

(Fig 3) Pictured from below vehicle

Hold Bracket flat and insert through opening in back of bumper

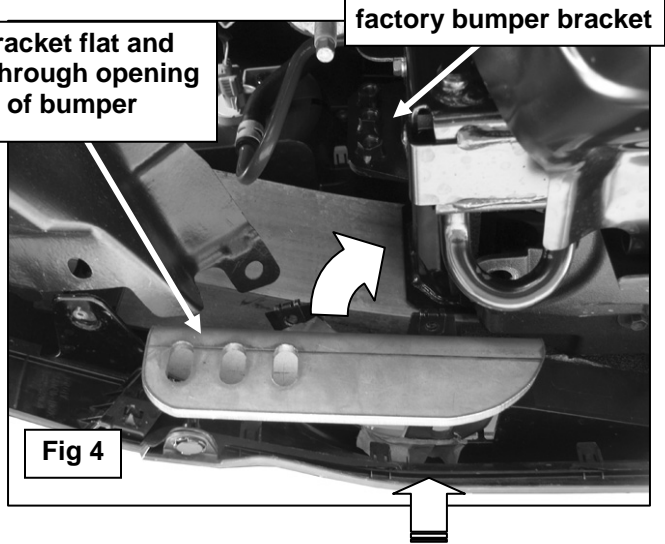

Line up Bracket and bolt to bumper bracket with (3) factory hex bolts

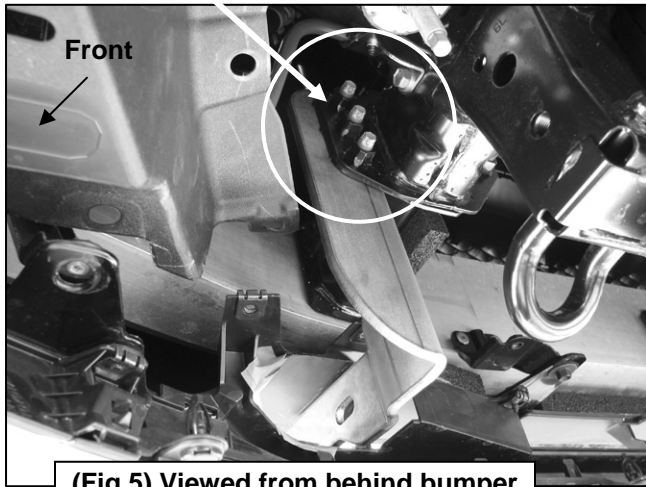

(Fig 5) Viewed from behind bumper

Pry up center of pin to remove 2pc plastic fastener

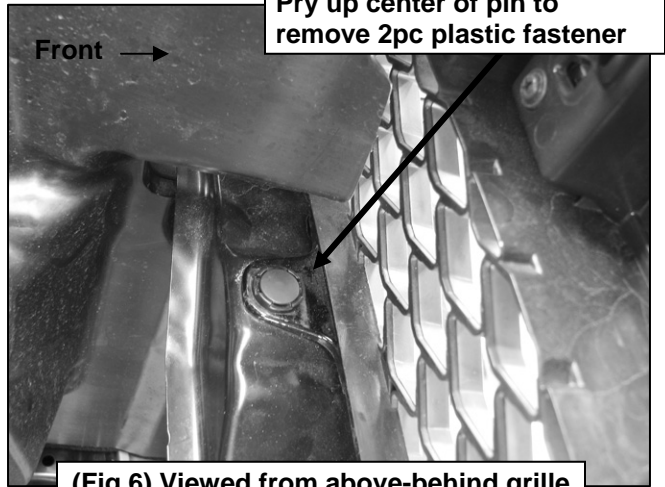

(Fig 6) Viewed from above-behind grille

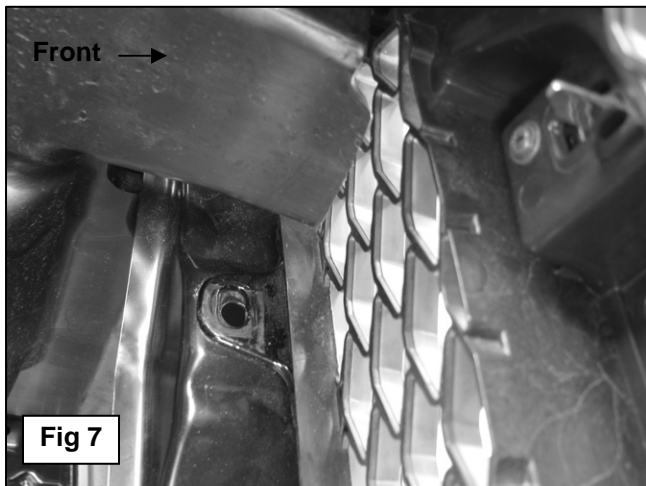
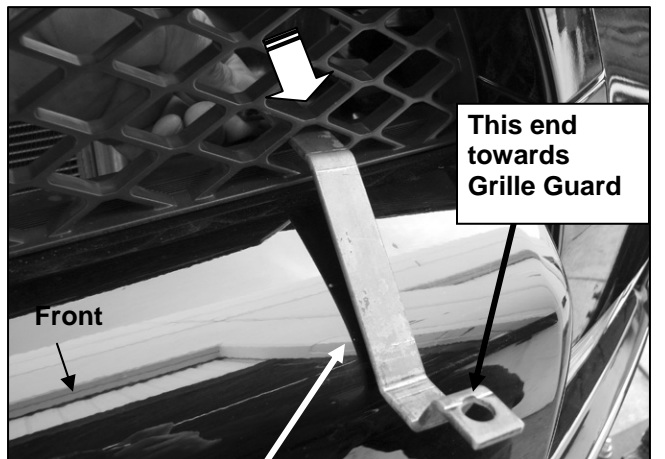

Fig 7

This end towards Grille Guard



(Fig 8) Apply Adhesive Backed Foam Tape to the back of the Top Brackets to prevent damage during install

Driver Side Installation Pictured

8mm x 30mm Hex Bolt
(2) 8mm x 24mm Flat Washers
8mm Nylon Lock Nut

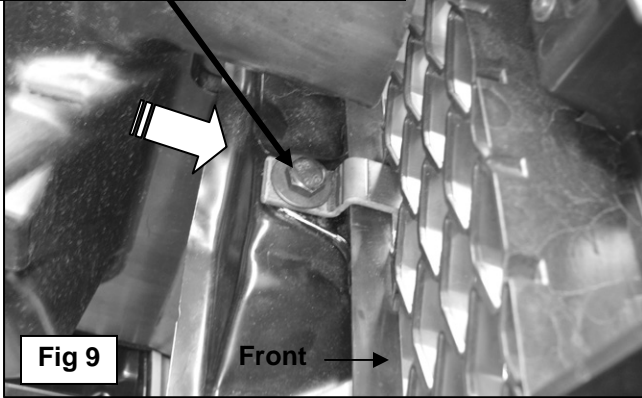

(2) 12mm x 30mm Hex Bolts
(4) 12mm Flat Washers
(2) 12mm Lock Washers
(2) 12mm Hex Nuts

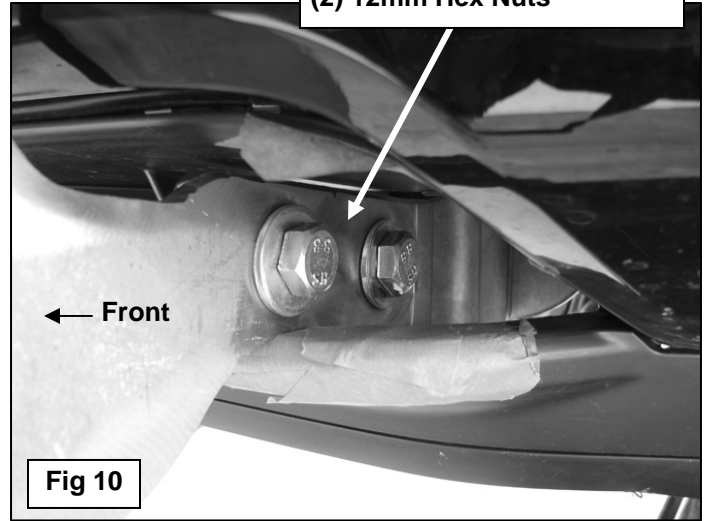

8mm x 30mm Button Head Bolt
8mm x 16mm Flat Washer (top)
8mm x 24mm Flat Washer (bottom)
8mm Nylon Lock Nut

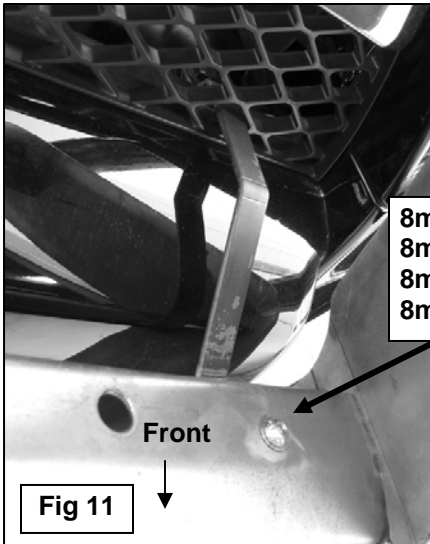

Cut out area illustrated
as an example only

