

ARIES OFFROAD

INSTALLATION INSTRUCTIONS

SIDEBAR 203031/203031-2
2008-2011 FORD ESCAPE & MAZDA TRIBUTE

PARTS LIST:

1	Driver/Left Sidebar	2	10-1.50mm x 35mm Bolt Plate
1	Passenger/Right Sidebar	2	10-1.50mm x 30mm Hex Bolts
1	Driver/Left Front Mounting Bracket	4	10-1.50mm x 45mm Hex Bolts
1	Passenger/Right Front Mounting Bracket	10	10mm ID x 30mm OD x 2.5mm Flat Washers
1	Driver/Left Rear Mounting Bracket	2	10mm Lock Washers
1	Passenger/Right Rear Mounting Bracket	2	10mm Hex Nuts
1	Driver/Left Front Support Bracket	2	10mm Nylon Lock Nuts
1	Passenger/Right Front Support Bracket	10	8-1.25mm x 25mm Hex Bolts
2	10mm Double Nut Plates	10	8mm Lock Washers
2	10mm ID x (35mm x 35mm) OD x 5mm Thick Square Washers	10	8mm ID x 24mm OD x 2mm Flat Washers

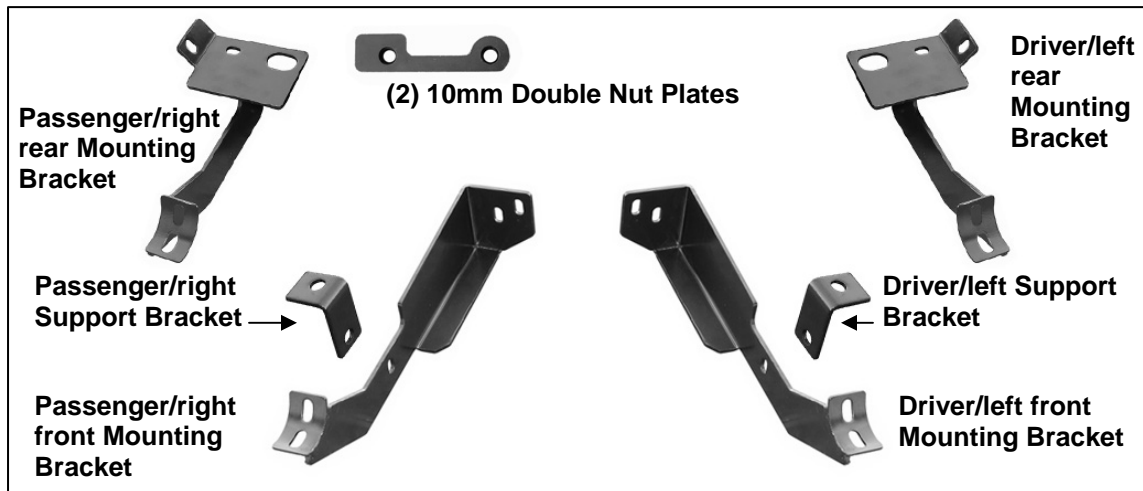

PROCEDURE:

- REMOVE CONTENTS FROM BOX. VERIFY ALL PARTS ARE PRESENT. READ INSTRUCTIONS CAREFULLY BEFORE STARTING INSTALLATION. DO NOT ATTEMPT INSTALLATION ALONE; PERSONAL INJURY OR DAMAGE TO THE VEHICLE MAY RESULT.**
- Starting the installation at the driver side-left front, remove the sheet metal screw in the rear of the front fender. Next, remove the three plastic clips from under the front of the plastic rocker trim panel, **(Figure 1)**. Once these are removed, gently pull the plastic panel toward the outside to locate the factory hole in the body panel, **(Figure 2)**. **NOTE:** Hold the front Mounting Bracket up in position to determine the approximate location of the correct mounting hole.
- Mark the location of the factory hole onto the plastic rocker panel. Using a 7/16" drill bit, carefully drill through the marked location on the plastic panel, **(Figure 3)**. **IMPORTANT:** Only drill through the plastic panel. Take precautions to avoid damage to the vehicle.
- Gently pull the cover aside to insert (1) 10mm x 35mm Bolt Plate with (1) 10mm Plastic Retainer into the factory hole in the body panel. Once the Bolt Plate is in place, thread the

Plastic Retainer down until it is flush against the body panel. Carefully reposition the plastic rocker panel over the Bolt Plate and into the original position, **(Figure 4)**. Secure with factory clips and metal screw.

5. Locate the three factory bolts on the side of the frame rail. Remove the two lower bolts only. Position the driver side front Mounting Bracket up to the frame rail. Line up the holes in the Mounting Bracket with (2) threaded holes. Secure the Mounting Bracket with the (2) factory bolts, **(Figure 5)**. Snug but do not tighten hardware at this time.
6. Place the Support Bracket onto the previously installed Bolt Plate using (1) 10mm Flat Washer, (1) 10mm Lock Washer and (1) 10mm Hex Nut. Attach the opposite end of the Support Bracket to the back of the Mounting Bracket with (1) 10mm x 30mm Hex Bolt, (2) 10mm Flat Washers and (1) 10mm Nylon Lock Nut, **(Figure 6)**. **NOTE:** Shorter tab on the Support Bracket mounts to the rocker panel, longer end to the Mounting Bracket. Do not tighten hardware at this time.
7. Moving to the rear of vehicle, locate the three holes in the floor panel next to the pinch weld. Remove the factory rubber plug if equipped, **(08 Escape only)**, facing the rear of the vehicle, **(Figure 7)**.
8. Insert (1) Double Nut Plate through the large round hole and line up the threaded nuts on the nut plate with the smaller round and oval holes, **(Figure 8)**. **NOTE:** Nut Plate must be flat against the inside of the body panel with the Welded nuts on top.
9. Position the driver side rear Mounting Bracket up to the vehicle. Insert (1) 10mm x 45mm Hex Bolt with (1) 10mm Flat Washer and (1) 10mm Lock Washer through the Mounting Bracket, small round hole and into the Double Nut Plate. Insert (1) 10mm x 45mm Hex Head Bolt, (1) 10mm Square Washer and (1) 10mm Lock Washer through the Mounting Bracket, large oval hole and into remaining nut in the Double Nut Plate, **(Figure 9)**. Do not tighten at this time.
Note for 2008 Escape driver side rear Mounting Bracket installation only: Use (1) 8mm x 25mm Hex Head Bolt, (1) 8mm Flat Washer, and (1) 8mm Lock Washer to attach the driver side Mounting Bracket to previously removed rubber plug location. You will not be using this 8mm bolt on the driver side of the Mazda Tribute or 09 Escape.
10. Carefully position the driver Sidebar onto the Mounting Brackets and secure using (4) 8mm x 25mm Hex Head Bolts, (4) 8mm Flat Washers and (4) 8mm Lock Washers, **(Figure 11)**. Snug but do not tighten hardware at this time.
11. Adjust and level the Sidebar and tighten all hardware at this time.
12. Repeat Steps 2-11 for passenger/right Sidebar.
NOTE: On 2009-010 Escape and Tribute models, the passenger side rear Mounting Bracket installs between the factory exhaust support and the body panel. Remove the (2) hex bolts securing the bracket, move the exhaust support slightly and install the passenger side Mounting Bracket as per Step 9, **(see Figure 10)**. Reinstall the exhaust support using the (2) factory hex bolts with (1) inserted through the exhaust support and the Mounting Bracket.
13. Do periodic inspections to the installation to make sure that all hardware is secure and tight.

To protect your investment, wax this product after installing. Regular waxing is recommended to add a protective layer over the finish. Do not use any type of polish or wax that may contain abrasives that could damage the finish.

For stainless steel: Aluminum polish may be used to polish small scratches and scuffs on the finish. Mild soap may be used also to clean the Sidebar.

For gloss black finishes: Mild soap may be used to clean the Sidebar.

Driver Front Mounting Bracket Installation Pictured

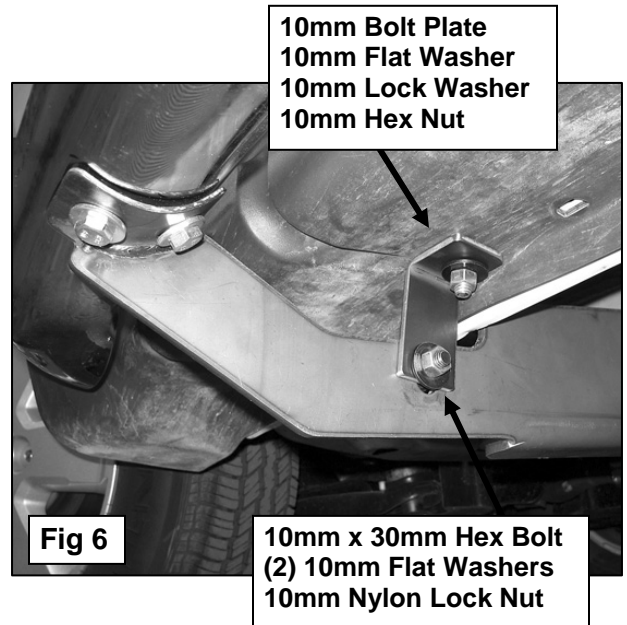
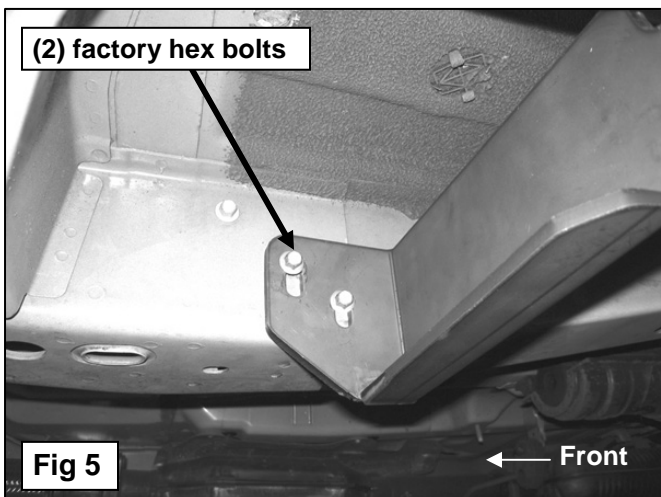
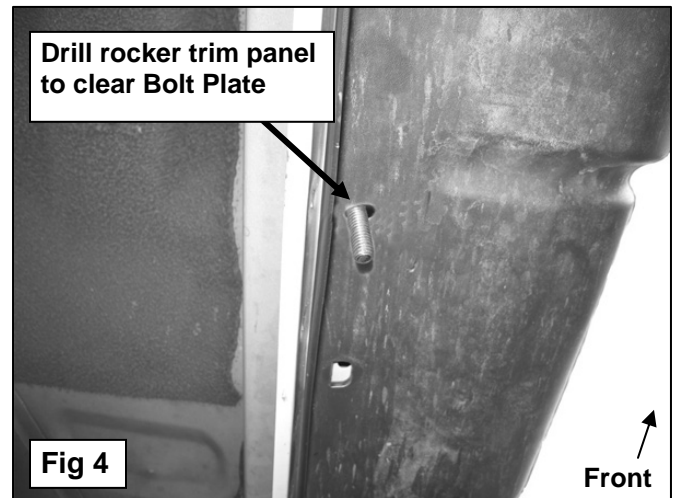
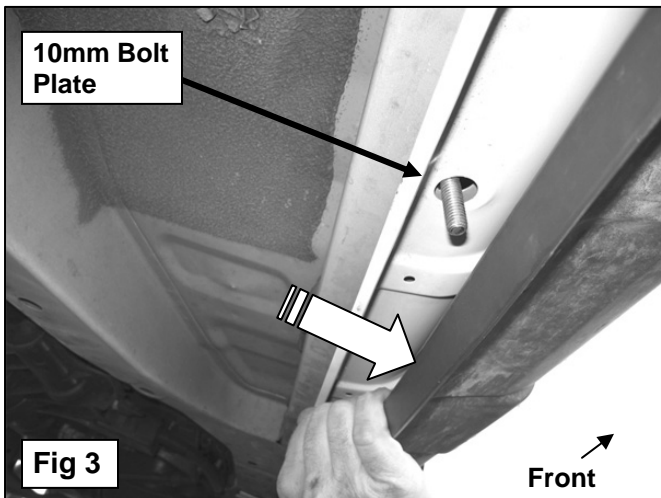
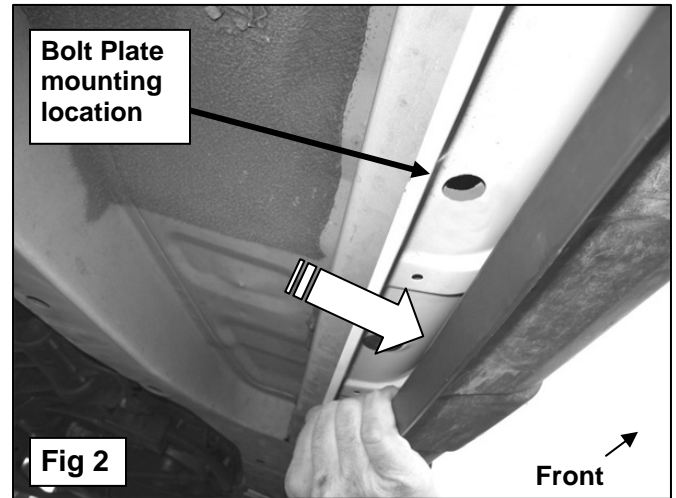
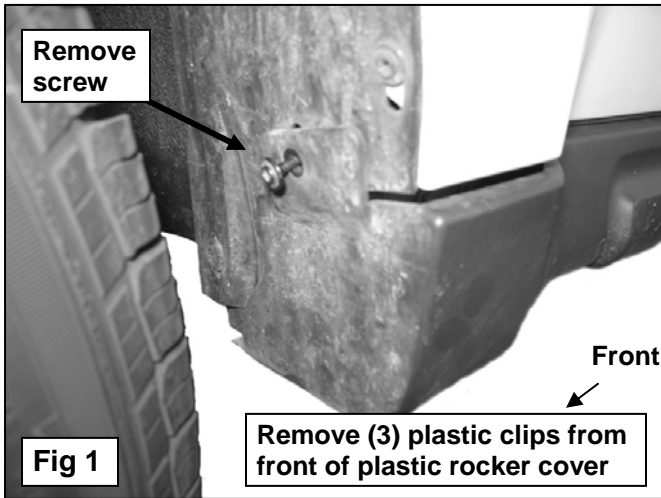

Driver Rear Mounting Bracket Installation Pictured

Remove rubber plug (08 Escape models only)

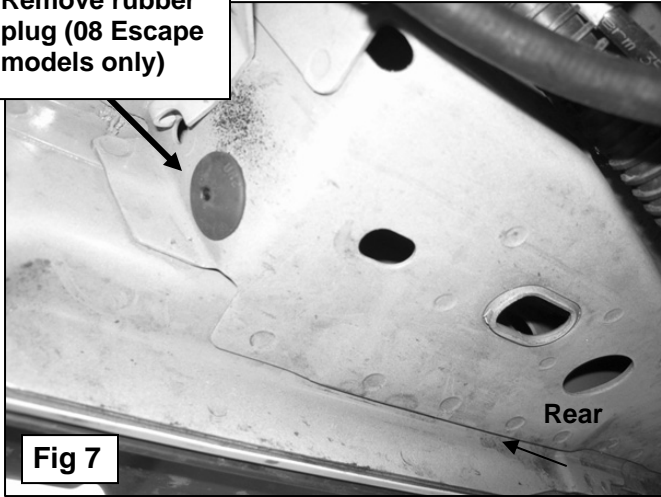

Fig 7

Insert Double Nut Plate and line up with (2) holes

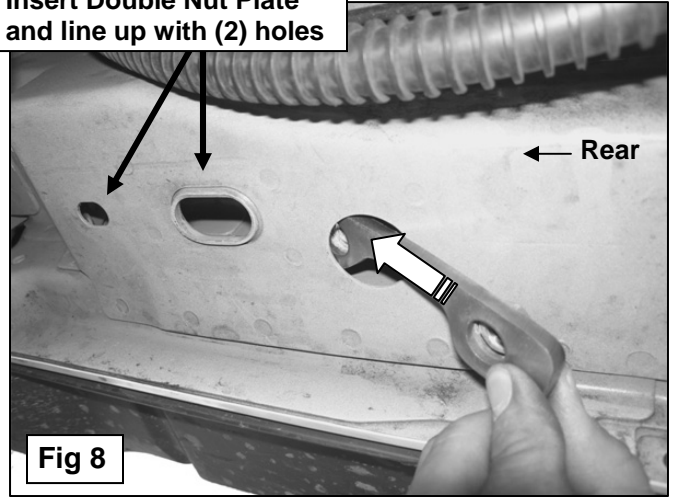
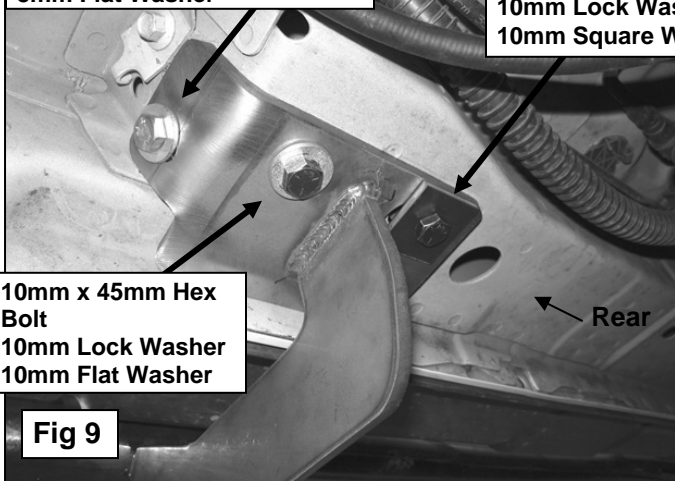

Fig 8

Driver side 08 Escape Only
8mm x 25mm Hex Head Bolt
8mm Lock Washer
8mm Flat Washer

10mm x 45mm Hex Bolt
10mm Lock Washer
10mm Square Washer



10mm x 45mm Hex Bolt
10mm Lock Washer
10mm Flat Washer

Fig 9

09-010 models-Install passenger side rear Mounting Bracket between exhaust support and body panel. Secure with factory hex bolts

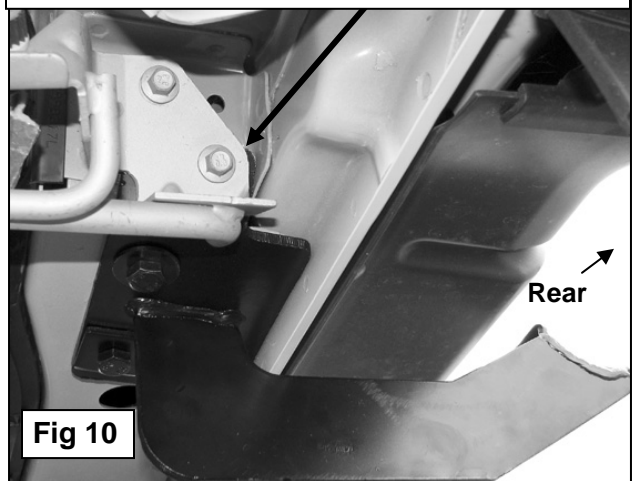

Fig 10

8mm x 25mm Hex Head Bolts
8mm Flat Washers
8mm Lock Washers

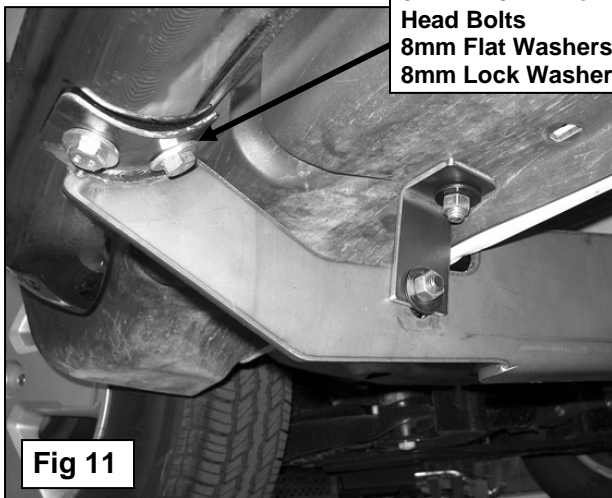

Fig 11



Complete Installation