







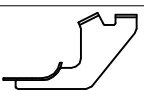

INSTALLATION INSTRUCTION
 For Toyota Tacoma Ext/Double Cab 05-13
 ITEM NO:4521

ATTENTION

1. Please read this installation instruction before installing this part.
 When install it, please pay attention to protecting your vehicles.

2. When you use it, please check this parts at a fix time-lapse, such as one month or two month.

PARTS LIST

No	Name	Photo	Qty	Remarks	No	Name	Photo	Qty	Remarks
①	Mount Bracket1		2	Lateral symmetry	⑧	LOCK NUT		24	M6
②	Mount Bracket2		4	Lateral symmetry					
③	Hex Bolt		12	M8					
④	Flat Washer		12	M8					
⑤	Lock Washer		12	M8					
⑥	"T"Bolt		6						
⑦	flat washer		24	M6					

Installation Diagram

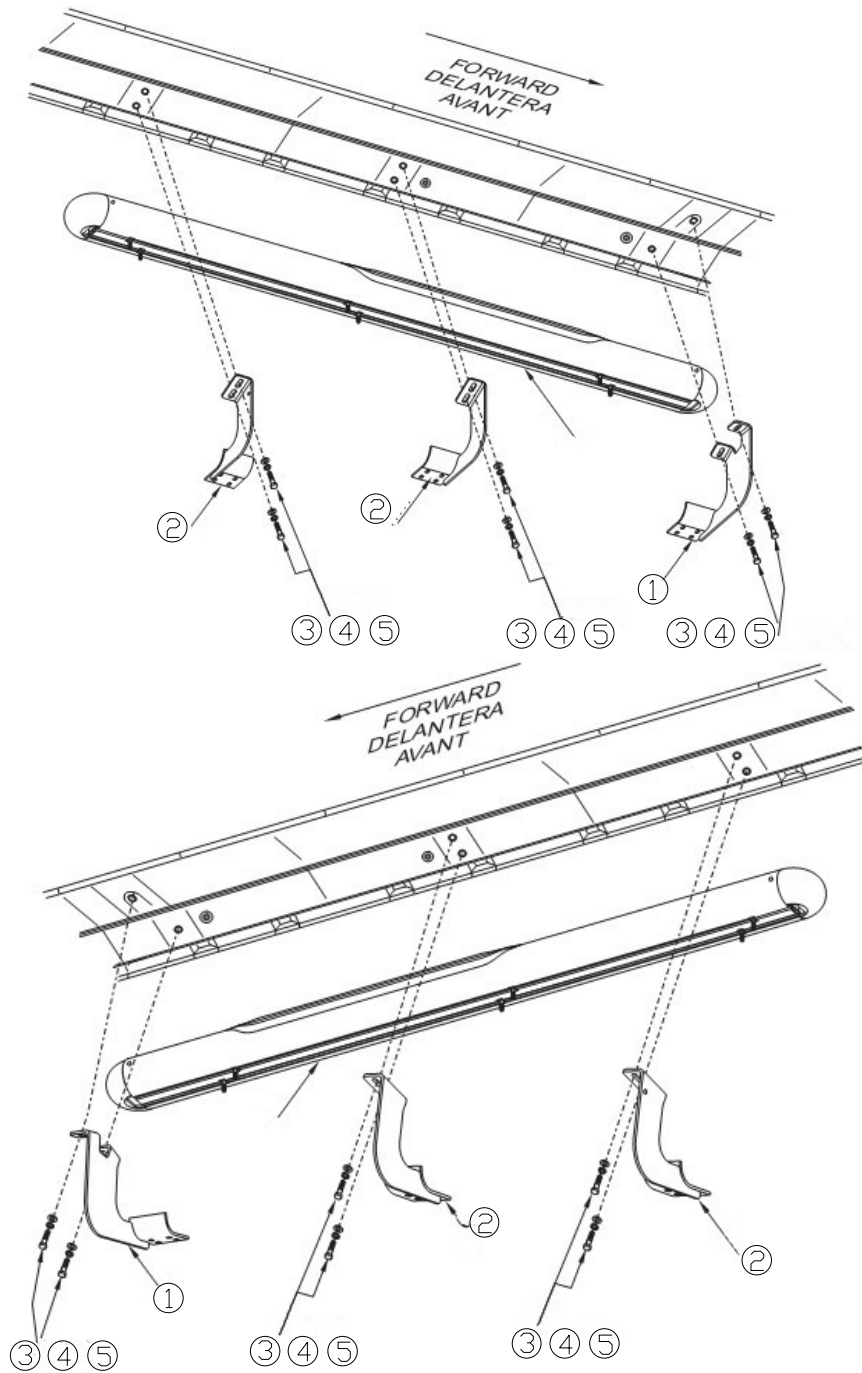

INSTALLATION STEPS

STEP 1: Check the parts in the box carefully if match above list .

STEP 2: Pls prepare the tools for installation, follow as: 10-12wrench, 14-17 wrench .

STEP 3: Put the mount bracket into the girder of the car, and tighten it with ③④⑤ .

STEP 4: Install the Side Bar to the mount bracket, and tighten it with ⑥⑦⑧.

STEP 5: Installation is finished.

Rely on premium running boards and step bars by Aries if you' re looking for quality and efficiency.