

INSTALLATION INSTRUCTION











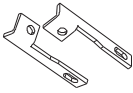



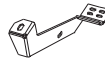

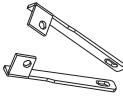
ITEM NO:4501

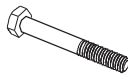
APPLICATION:Dodge Ram 1500-Quad Cab 2002-2008

ATTENTION

1. Please read this installation instruction before installing this part.
When install it, please pay attention to protecting your vehicles.
2. When you use it, please check this parts at a fix time-lapse, such as one month or two month.

PARTS LIST

No	Name	Photo	Qty	Remarks	No	Name	Photo	Qty	Remarks
A	mount bracket		2	LATERAL SYMMETRY	J	Hex Bolt		4	M10X30
B	front bracket		2	LATERAL SYMMETRY	K	flat washer		12	10mm
C	rear bracket		2	LATERAL SYMMETRY	L	Lock washer		8	10mm
D	support bracket		2	LATERAL SYMMETRY	M	Hex Nut		8	M10
E	Hex Bolt		4	M12X120	N	Plastic push		4	10mm
F	45mm spacer		4	12mm	O	"T"Bolt		4	
G	flat washer		4	12mm	P	Flat washer		16	M6
H	Lock washer		4	12mm	I	LOCK NUT		16	M6
I	"T" Bolt		4	M10X25					

INSTALLATION STEPS

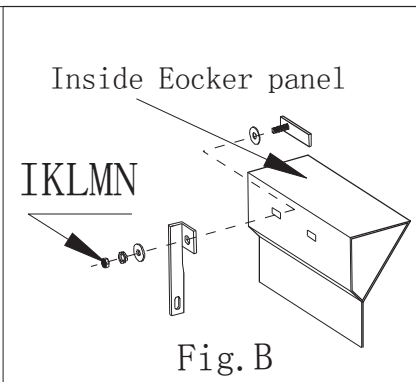
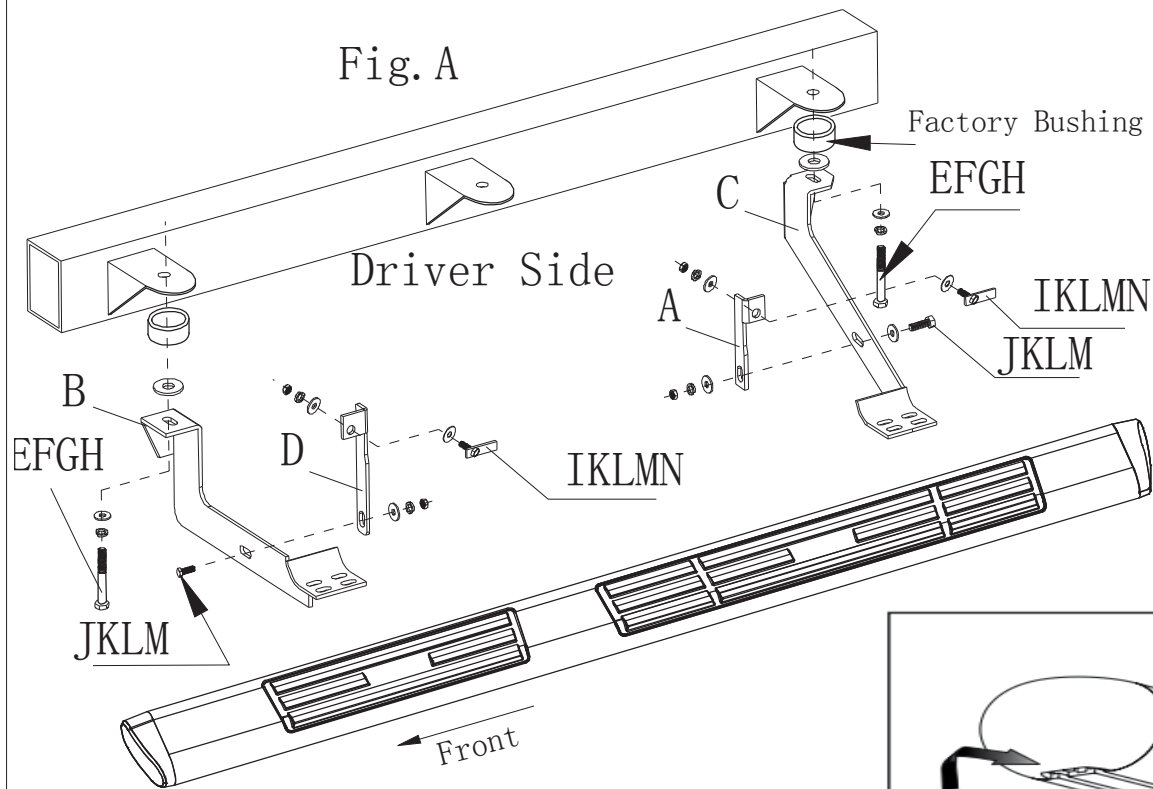

INSTALLATION STEPS

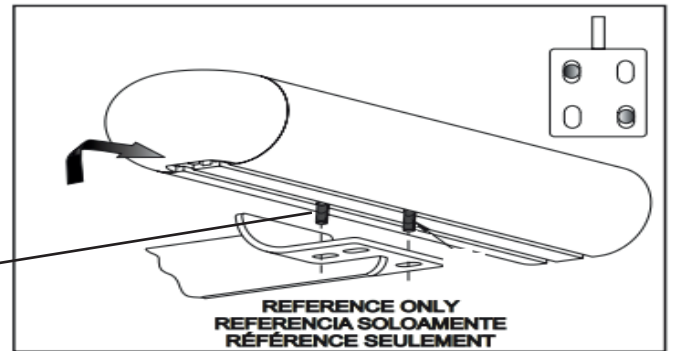

- STEP 1. Remove all contents from the received box and check stainless steel tube for any dent. Also verify all brackets and bolts against the parts list.
- STEP 2. Read installation manual and installation drawing completely. Understand all brackets and bolts before installation.
- STEP 3. Remove the body mount bolts from the front and rear body mounts underneath cab of truck and discard. (Keep the factory bolts and bushings) Loosely bolt front bracket to front body mount using the (E F G H) as shown (Fig.A). (Make sure factory bushing is put on the same way is taken off.)
- STEP 4. Loosely bolts rear brackets to rear body mounts using the (E F G H) as shown (Fig.A). (Make sure factory bushing is put on the same way is taken off.)
- STEP 5. Insert (I) in front inside of pinch weld and hold in place with Push-nut(M). Mount front support brace to T-bolt using flat(K), lock(L) washers and hex head nut(M) as shown. Attach rear support brace to rear bracket using hex bolt(J), flat(K) and lock(L) washers, and hex head nut(M) as shown in Fig.A.
- STEP 6. Insert T-bolt(I) in rear inside of pinch weld and hold in place with Push-nut(M). Mount front support brace to T-bolt using flat(K), lock(L) washers and hex head nut(M) as shown Fig.B. Attach rear support brace to rear bracket using hex bolt(J), flat(K) and lock(L) washers, and hex head nut(M) as shown in Fig.A.
- STEP 7. Mount step bar to front and rear brackets using T bolt(O), nut(I), flat(P) washers as shown. Head tighten into nutsert on the bottom of the step bar. Adjust position of step bar and tighten all bolts.

[Learn more about other running boards and step bars by Aries on our website.](#)