









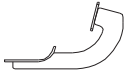

INSTALLATION INSTRUCTION  
For Ford F150 Regular/Super Cab 97-04  
ITEM NO:4506

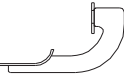
**ATTENTION**

1. Please read this installation instruction before installing this part.  
When install it, please pay attention to protecting your vehicles.

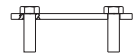
2. When you use it, please check this parts at a fix time-lapse, such as one month or two month.

**PARTS LIST**

No	Name	Photo	Qty	Remarks	No	Name	Photo	Qty	Remarks
①	Mount Bracket		2		⑧	"T"Bolt		4	
②	Mount Bracket		2		⑨	flat washer		16	M6
③	"T"Bolt		4	M10	⑩	LOCK NUT		16	M6
④	"T"Bolt		2	M10					
⑤	Flat Washer		12	M10					
⑥	Lock Washer		12	M10					
⑦	Hex Nut		12	M10					

## Installation Diagram

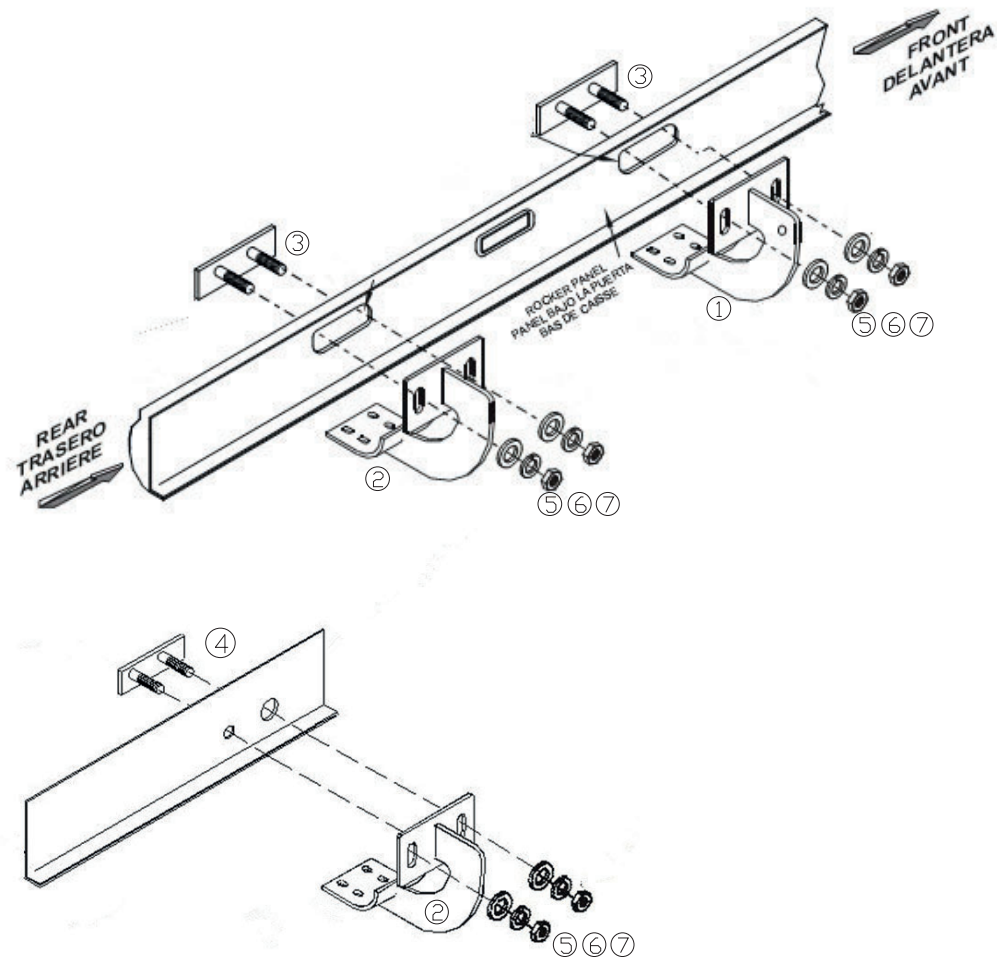

STEP-1

STEP-2

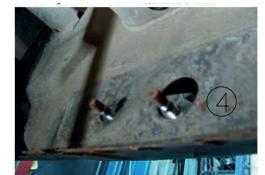

STEP-3

STEP-4

### INSTALLATION STEPS

STEP 1: Check the parts in the box carefully if match above list .

STEP 2: Pls prepare the tools for installation, follow as: 10-12wrench, 14-17 wrench .

STEP 3: Put the mount bracket into the girder of the car, and tighten it with "T" Bolt ③④.

STEP 4: Install the Side Bar to the mount bracket, and tighten it with T" Bolt ③.

STEP 5: Installation is finished.

Learn more about other running boards and step bars by [Aries](#) on our website.