



# INSTALLATION MANUAL

## Parts List

1	Center section
2	Hex bolt, M6 x 20mm
2	Flat washer, M6
3	Nylock nut, M6
8	Hex bolt, M12 x 35mm
16	Flat washer, M12 x 24mm
8	Lock washer, M12
8	Nut, M12

Additional hardware may be present depending on the configuration purchased. See the individual component installation pages for additional hardware lists

## Tools Required

Ratchet	Ratchet extension
Cut-off tool	Phillip screwdriver
Allen wrench	Flathead screwdriver
7mm socket	Wrench, 5mm
10mm socket	Wrench, 10mm
13mm socket	Wrench, 16mm
16mm socket	Wrench, 18mm
18mm socket	Level

## Level of Difficulty

Moderate

## Product Image

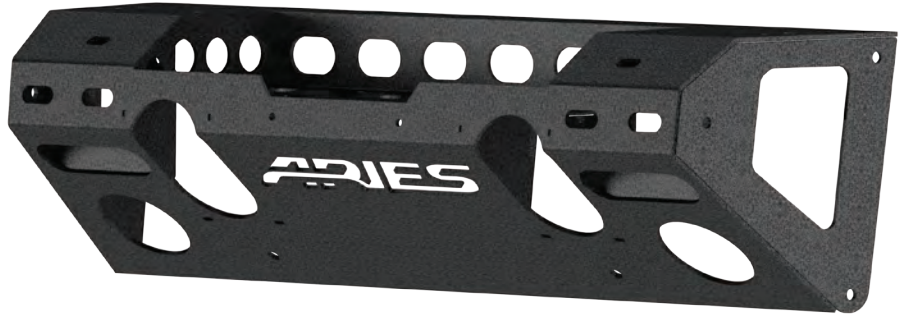

See pages 2 and 3 for available modular bumper configurations

## Notes and Maintenance

Before you begin installation, read all instructions thoroughly.

Proper tools will improve the quality of installation and reduce the time required.

For black finishes, mild soap may be used to clean the product.

Refer to the table to the left when securing hardware during the installation process to help prevent damage to the product or vehicle.

## Torque Specifications

METRIC		SAE	
M6 bolt	3 ft.-lbs.	1/4" bolt	3 ft.-lbs.
M8 bolt	7 ft.-lbs.	5/16" bolt	7 ft.-lbs.
M10 bolt	16 ft.-lbs.	3/8" bolt	16 ft.-lbs.
M12 bolt	28 ft.-lbs.	7/16" bolt	20 ft.-lbs.
--	--	1/2" bolt	28 ft.-lbs.

# / FRONT MODULAR BUMPERS

## Aluminum front modular bumper kits

Aluminum Front Modular Bumper Kits							
Kit#	Center#	Side#	Side Style	LED Lights	Guard#	Guard Style	Guards Included
2082020	2081001	2081201	Side extension	Not included	2081254	Round	Center and sides
2082023	2081001	2081201	Side extension	Not included	--	--	--
2082059	2081001	2081201	Side extension	Not included	2081255	Round	Center only
2082047	2081001	2081201	Side extension	Not included	2081101	Angular	Center only
2082046	2081001	2081205	Corner	Included	2081101	Angular	Center only
2082058	2081001	2081205	Corner	Included	2081255	Round	Center only
2082044	2081001	2081205	Corner	Included	--	--	--
2082055	2081001	2081207	Corner	Not compatible	2081101	Angular	Center only
2082054	2081001	2081207	Corner	Not compatible	2081255	Round	Center only
2082052	2081001	2081207	Corner	Not compatible	--	--	--

All modular bumpers and components are finished with a textured black powder coat

## Steel front modular bumper kits

Steel Front Modular Bumper Kits							
Kit#	Center#	Side#	Side Style	LED Lights	Guard#	Guard Style	Guards Included
2082030	2081000	2081204	Side extension	Not included	2081250	Round	Center and sides
2082032	2081000	2081204	Side extension	Not included	--	--	--
2082040	2081000	2081204	Side extension	Not included	2081252	Round	Center only
2082042	2081000	2081204	Side extension	Not included	2081100	Angular	Center only
2082043	2081000	2081200	Corner	Included	2081100	Angular	Center only
2082056	2081000	2081200	Corner	Included	2081252	Round	Center only
2082057	2081000	2081200	Corner	Included	--	--	--
2082051	2081000	2081206	Corner	Not compatible	2081100	Angular	Center only
2082050	2081000	2081206	Corner	Not compatible	2081252	Round	Center only
2082048	2081000	2081206	Corner	Not compatible	--	--	--

All modular bumpers and components are finished with a textured black powder coat

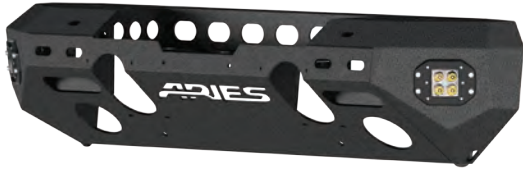

2082044 & 2082057

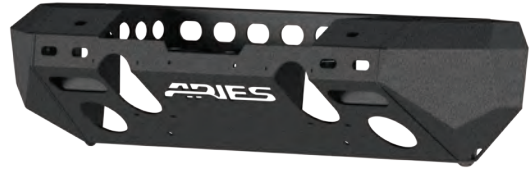

2082052 & 2082048



2082058 & 2082056



2082054 & 2082050



2082046 & 2082043

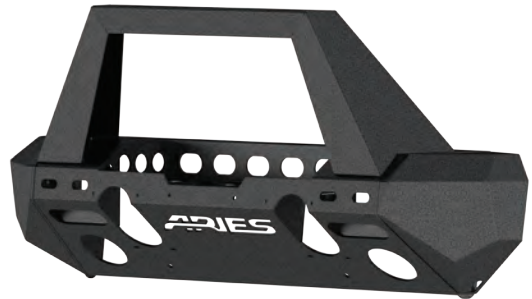

2082055 & 2082051



2082023 & 2082032

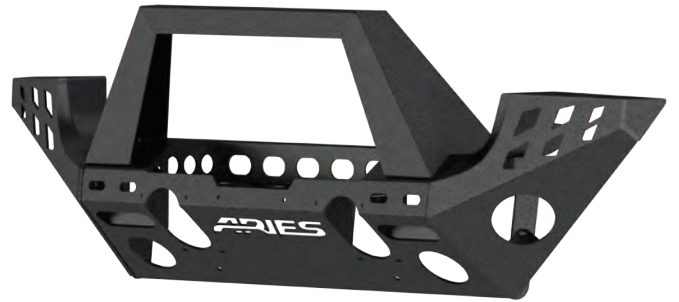

2082047 & 2082042



2082059 & 2082040



2082020 & 2082030

# 1 / FACTORY BUMPER REMOVAL

## Step 1

Using a flat head screwdriver, pry and remove four plastic push pins holding the air dam in place. Remove the air dam from underneath the vehicle.

Once removed, pry off the fasteners holding the brackets to the frame.

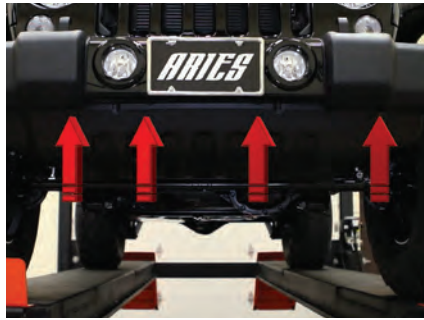

## Step 2

From behind the bumper, disconnect the wiring harness attached to each fog light. Unclip the wiring harness from the bumper cover.



## Step 3

Locate two fasteners holding the frame cover in place on top of the bumper. Remove these with a Phillips screwdriver.



#### Step 4

When facing the Jeep head-on, slide the cover to the left to expose the driver side bolts holding the bumper in place. Remove the four nuts holding the bolts onto the bumper frame with an 18mm socket.

Repeat this on the passenger side.



#### Step 5

When all the bolts have been removed carefully lift the bumper from the frame and set on a flat work surface.



#### Step 6

Remove the stock fog lights to be used in the new ARIES front bumper.

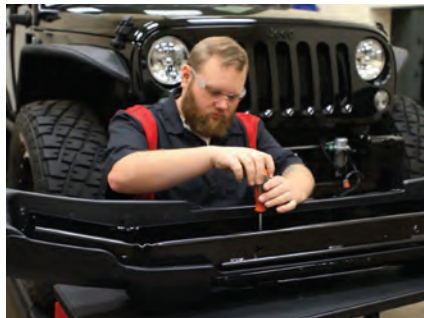

# 2A / SIDE INSTALLATION WITHOUT LEDS

## Parts List

1	End cap, passenger / right
1	End cap, driver / left
6	Hex bolt, M10 x 35mm
12	Flat washer, M10
6	Lock washer, M10
6	Nut, M10



2081204 steel  
2081201 aluminum



2081206 steel  
2081207 aluminum



## Step 1

Set the new ARIES center section onto a flat work surface. Lift the bumper side into place and insert a 10mm hex bolt with a locking and flat washer.

Secure the bolt with a second flat washer and a hex nut.

Repeat this for all three attachment points.

Snug the hardware at this time, but do not tighten.



## Step 2

Repeat steps 1 and 2 on the opposite side.

With both extensions loosely installed, check to make sure that the bumper corners match up.

Adjust if necessary and fully tighten all the hardware with a 16mm socket and wrench



# 2B / SIDE INSTALLATION WITH LEDS

## Parts List

1	End cap, passenger / right
1	End cap, driver / left
4	Flat washer, M6
4	Nylock nut, M6
4	Socket cap screw, M6 x 20mm
6	Hex bolt, M10 x 35mm
12	Flat washer, M10
6	Lock washer, M10
6	Nut, M10
2	LED Lights
1	Rubber gasket

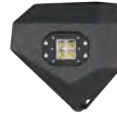

2081200 steel  
2081205 aluminum

## Step 1

Set the new ARIES end cap onto a flat work surface. Lift the LED light into place and insert rubber gasket into place as shown.

When in place secure LED light with 6mm socket cap screw, flat washer and nylock nut.

Repeat this for all four attachment points.

Tighten all hardware and repeat steps for second light.

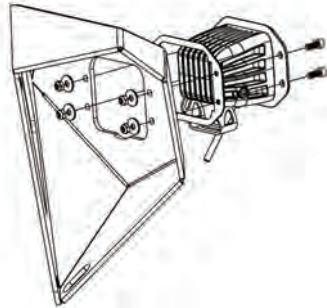

## Step 2

Set the new ARIES center section onto a flat work surface. Lift the bumper side into place and insert a M10 hex bolt with a locking and flat washer.

Secure the bolt with a second flat washer and a hex nut.

Repeat this for all three attachment points.

Snug the hardware at this time, but do not tighten.

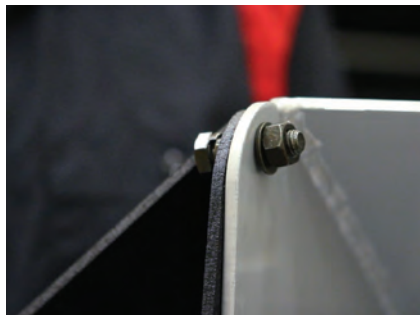

### Step 3

Repeat steps 1 and 2 on the opposite side.

With both extensions loosely installed, check to make sure that the bumper corners match up.

Adjust if necessary and fully tighten all the hardware with a 16mm socket and wrench

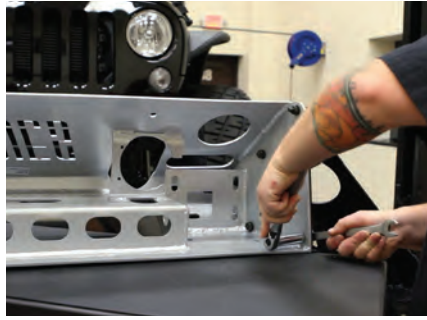

## 3 / ANGULAR BRUSH GUARD INSTALLATION

### Parts List

1	Stinger
6	Nylock nut, M6
4	Hex bolt, M10 x 25mm
8	Flat washer, M10
4	Lock washer, M10
4	Nut, M10
6	Button head cap screw, M6 x 20mm
1	Cover plate



2081100 steel  
2081101 aluminum

### Step 1

Stand up brush guard and place cover plate on brush guard and inset 6mm button head cap screw with flat washer. Secure the bolt with a nylock nut.

Repeat this for all six attachment points. Adjust if necessary and fully tighten all the hardware with allen wrench.



### Step 2

Place center section onto a flat work surface. Lift the brush guard into place and insert M10 hex bolt with locking and flat washer.

Secure the bolt with a second flat washer and a hex nut.

Repeat this for all four attachment points.

Adjust if necessary and fully tighten all the hardware with a 16mm socket and wrench.

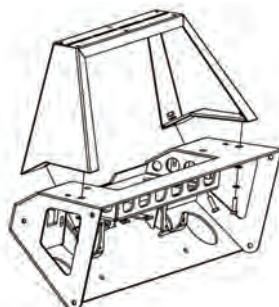



# 4 / BRUSH GUARD INSTALLATION

## Full Brush Guard Parts List

1	Brush guard, center
1	Brush guard, passenger / right
1	Brush guard, driver / left
6	Hex bolt, M10 x 35mm
12	Flat washer, M10
6	Lock washer, M10
6	Nut, M10



2081250 steel  
2081254 aluminum

## Center Brush Guard Parts List

1	Brush guard, center
2	Hex bolt, M10 x 35mm
4	Flat washer, M10
2	Lock washer, M10
2	Nut, M10



2081252 steel  
2081255 aluminum

## Step 1

For mid bumper kits skip to step 2.  
On full bumper kits, attach the two side tubes with the provided M10 hex bolts, lock washers and flat washers.  
Align and fully tighten the hardware with a 16mm socket.



## Step 2

Finalize the brush guard installation by attaching the center brush guard loop.  
Secure the center tube with the provided M10 hex bolts, lock washers and flat washers.  
Ensure the tube is aligned properly and fully tighten the hardware with a 16mm socket.



# 5 / MODULAR BUMPER INSTALLATION

## Step 1

For 2012 models and later, you will see a vacuum pump on the driver side. This will need to be moved to accommodate the new bumper.

With a 10mm socket, loosen the rear bolt and fully remove the front bolt. Swing the vacuum pump toward the rear of the vehicle and snug the rear bolt, but do not fully tighten.



## Step 2

With the vacuum pump moved, you will be left with the factory bracket that originally held the front post in place. This will need to be removed to allow clearance for the winch receiver plate to fit into place.

Using a cutoff tool, carefully remove the front post bracket.

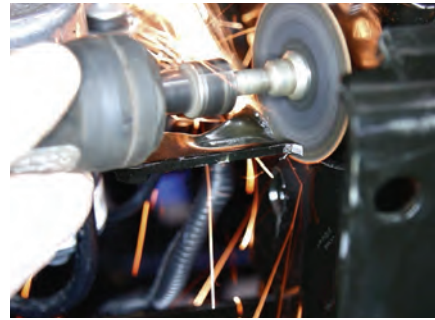
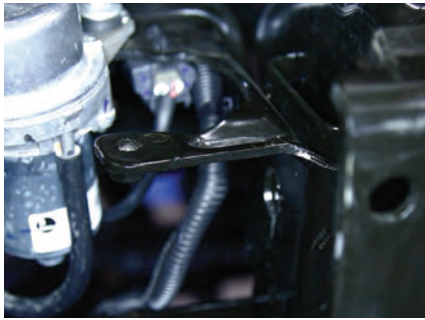

## Step 3

Set the fog lights into the new bumper. Each light will have three attachment points.

Insert a 4mm socket cap screw with flat washer and fasten with a flat washer and nylock nut.

Tighten with a 7mm socket and included Allen wrench. Repeat this for the other light.

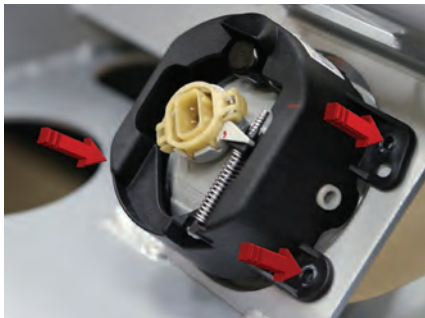

## Step 4

With help, lift the bumper into place over the pre-mounted 12mm bolts in the factory bumper mount locations.

If the winch receiver plate bracket was not installed, the included 12mm bolts will be installed in step 7.



### Step 5

Insert a M12 hex bolt with flat washer behind the bumper bracket and secure with a flat and lock washer with a hex nut.

Depending on the year of the Jeep, there may be as few as two mounting points to attach to. This example has three per side.

Snug all hardware at this time, but do not fully tighten.



### Step 6

Reattach the fog lights and wire harness to the bumper.



### Step 7

Take vacuum pump and place threaded bolt through tab on bumper and attach with M6 nylock nut.



### Step 8

Check to make sure the bumper is level. Adjust if necessary and tighten all hardware. We suggest doing periodic inspections to make sure all hardware is tight and secure.

Congratulations on completing the installation of your new ARIES modular bumper.

