



INSTALLATION INSTRUCTIONS
LICENSE PLATE RELOCATION BRACKET
PART NUMBER 45-0000

PARTS LIST:

1	License Plate Bracket
2	6-1.00mm x 20mm Screws
2	Adhesive Foam Strips

PROCEDURE:

- 1. REMOVE CONTENTS FROM BOX. VERIFY ALL PARTS ARE PRESENT. READ INSTRUCTIONS CAREFULLY BEFORE STARTING INSTALLATION.**
2. Attach two Adhesive Foam Strips on the Relocation Bracket as shown in Figure 1.
3. Remove center skid plate bolt from Bull Bar. Position Relocation Bracket against cross tube and on top of skid plate. Attach Relocation Bracket to bull bar using the skid plate bolt removed in this step (Figure 2). Tighten at this time
4. Attach license plate to Relocation Bracket using the included (2) 6mm x 20mm Screws. Tighten at this time

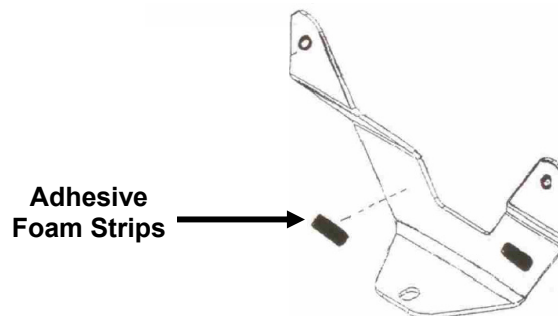

Figure 1

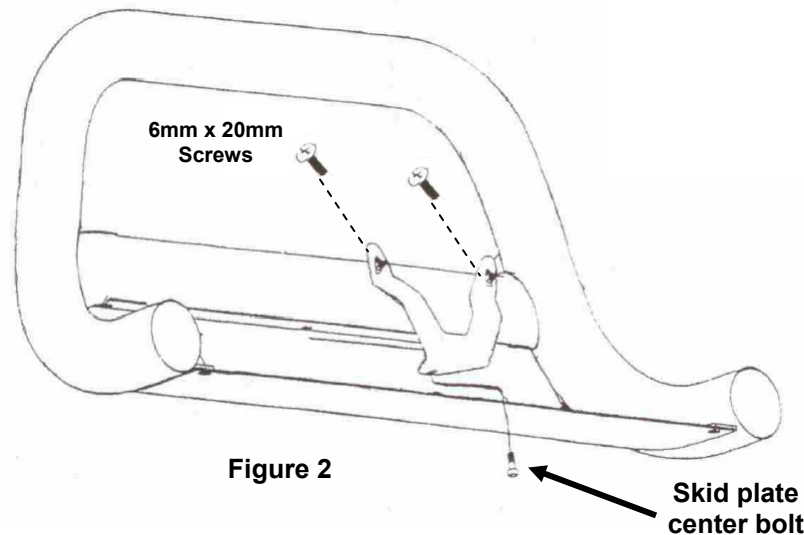

Figure 2