



INSTALLATION INSTRUCTIONS

GRILLE GUARD

2015 F-150

P/N 3066;3066-2

PARTS LIST:

Qty	Description	Qty	Description
1	Grille Guard	4	10-1.5mm x 30mm Hex Bolt
1	Driver/left Frame Bracket	8	10mm x 24mm OD x 2.2mm Flat Washer
1	Passenger/right Frame Bracket	4	10-1.5mm Nylon Lock Nut
1	Driver/left Top Bracket	2	8-1.25mm x 40mm Hex Bolt
1	Passenger/right Top Bracket	2	8-1.25mm x 30mm Hex Bolt
2	12-1.75mm Double Nut Plate	6	8mm x 22mm OD x 2mm Flat Washer
4	12-1.75 x 35mm Hex Bolt	2	8mm Lock Washer
4	12 x 32mm OD x 3mm Flat Washer	2	8-1.25mm Nylon Lock Nut
4	12mm Lock Washer		

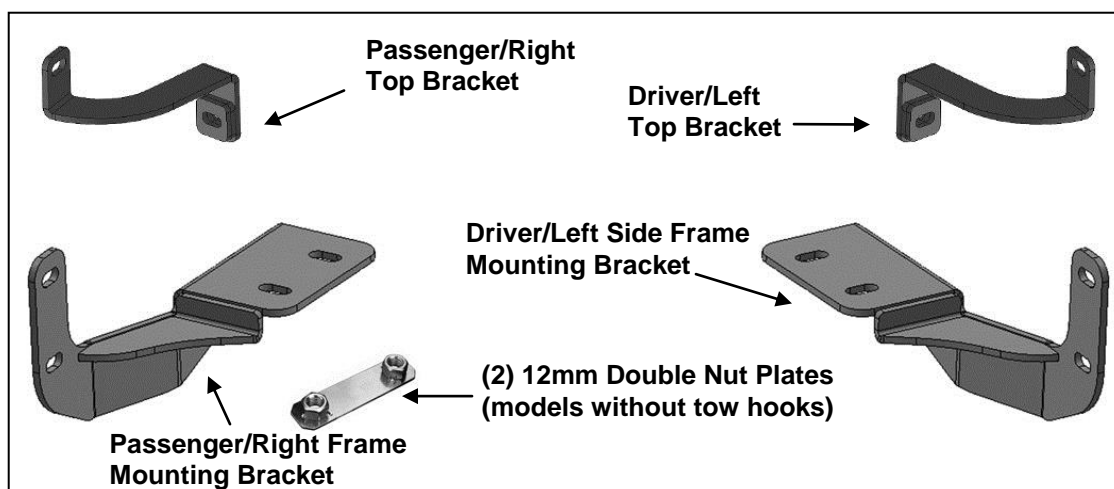

PROCEDURE:

REMOVE CONTENTS FROM BOX. VERIFY ALL PARTS ARE PRESENT. READ INSTRUCTIONS CAREFULLY BEFORE STARTING INSTALLATION. ASSISTANCE IS RECOMMENDED. CUTTING IS REQUIRED ON VEHICLES WITHOUT TOW HOOKS. NOTE: It may be necessary to remove/relocate the front license plate and license plate bracket on models equipped with Ecoboost engine.

- Determine if the vehicle is or is not equipped with factory tow hooks, **(Figures 1 & 2)**.

Installation on vehicles with Factory Tow Hooks:

- Remove the driver side tow hook and plastic trim between tow hook and splash guard, **(Figure 1)**. **NOTE:** Do not move the nut plate inside the frame. Plastic trim will not be reinstalled.
- Select the driver side Frame Mounting Bracket, **(Figure 6)**. Insert the Bracket between the tow hook and the frame. Reattach the tow hook, (without trim), with the factory bolts. Leave hardware loose at this time.
- Repeat previous **Steps a & b** for passenger side Frame Bracket installation.
- Proceed to **Step 2**.

Installation on vehicles without Tow Hooks:

- From behind the bumper, release the clips attaching the plastic bumper pads to the steel bumper, **(Figures 3A & 3B)**. Temporarily remove the pads and license plate mounting bracket. Next, remove the air dam and plastic splash guard.
- Insert (1) 12mm Double Nut Plate into the end of the driver side of the frame, **(Figures 4A & 4B)**. Line up the Nut Plate with the holes in the bottom of the frame, **(Figure 5)**.
- Select the driver side Frame Mounting Bracket. Attach the Bracket to the bottom of the frame and Nut Plate with the included (2) 12mm x 35mm Hex Bolts, (2) 12mm Lock Washers and (2) 12mm Flat Washers, **(Figure 6)**. Leave hardware loose at this time.
- Repeat the previous **Steps a—c** for passenger side Frame Mounting Bracket installation.
- Do not reinstall the plastic splash guard at this time, (See **Step 6**).

2. From under and behind the bumper, locate the top of the driver side bumper bracket, **(Figures 7 & 8)**. Next, locate the center bumper bolt attaching the top of the bracket to the back of the bumper. It may be necessary to temporarily release the clips and move the rubber cover to access the bumper bolts, **(Figure 7)**. Remove the hex bolt from the top-center of the bumper bracket, **(Figures 8 & 10A)**.
3. Select the driver side Top Bracket, **(Figure 9)**. Insert the Top Bracket, (end with welded spacer), into the space between the top of the bumper and the bottom of the grille. Line up the Bracket with the mounting hole in the bumper bracket. Attach the Bracket to the bumper bracket with the included (1) 8mm x 40mm Hex Bolt, (1) 8mm Lock Washer and (1) 8mm Flat washer, **(Figures 10A—10C)**. Leave loose at this time.
4. Repeat **Steps 2 & 3** to install the passenger side Top Bracket.
5. With assistance, place the Grille Guard up to the outside of the Frame Brackets. Attach the Grille Guard to the Brackets with (4) 10mm x 30mm Hex Bolts, (8) 10mm Flat Washers and (4) 10mm Nylon Lock Nuts, **(Figure 12)**. Snug but do not tighten hardware at this time.
6. Center the Grille Guard on the vehicle. Once properly adjusted, fully tighten the (4) 12mm Hex Bolts attaching the Frame Brackets to the bottom of the frame and/or tow hook, **(Figure 6)**. Do not tighten any other hardware at this time.

Models with Tow Hooks: Proceed to **Step 7**.

Models without tow hooks: Temporarily remove the Grille Guard.

- a. Hold the plastic splash guard up in place over the Frame Brackets.
 - b. Mark the location of the Brackets onto the back of the plastic splash guard, **(Figure 11)**.
 - c. Use a sharp knife or hacksaw blade to cut slots out of the cover to clear the Brackets. For best results, start with a small slot and gradually increase the size until the Brackets fit through the guard. Do not cut through the front or rear edge of the splash guard, **(Figure 11)**.
 - d. Reinstall the splash guard and air dam.
 - e. Reinstall the Grille Guard.
7. Line up the driver side Top Bracket with the hole in the upright on the Grille Guard. Attach the Bracket to the Grille Guard with (1) 8mm x 30mm Hex Bolt, (2) 8mm Flat Washers, (1) 8mm Nylon Lock Nut, **(Figure 12)**.
 8. Repeat **Step 7** to attach the passenger side Top Bracket to the Grille Guard.
 9. Align and adjust the Grille Guard and tighten all hardware.
 10. Do periodic inspections to the installation to make sure that all hardware is secure and tight.

To protect your investment, wax this product after installing. Regular waxing is recommended to add a protective layer over the finish. Do not use any type of polish or wax that may contain abrasives that could damage the finish.

For stainless steel: Aluminum polish may be used to polish small scratches and scuffs on the finish. Mild soap may be used also to clean the Grille Guard.

For gloss black finishes: Mild soap may be used to clean the Grille Guard.

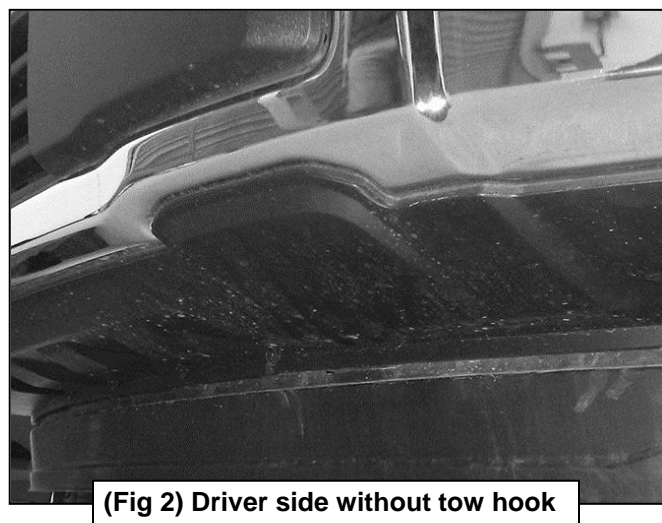
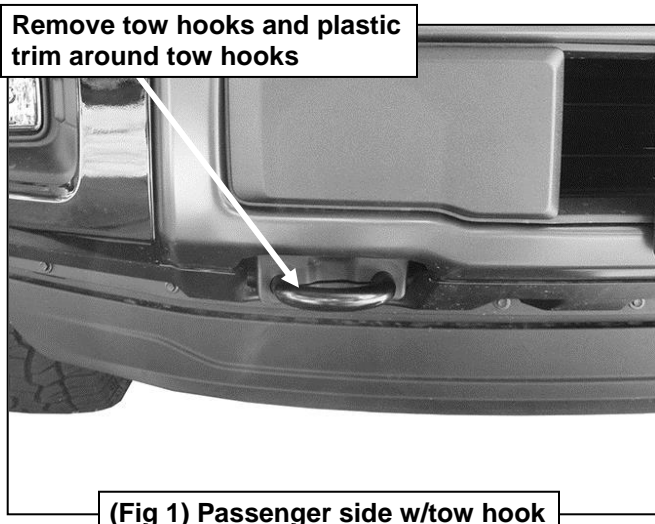

Driver Side Installation Pictured

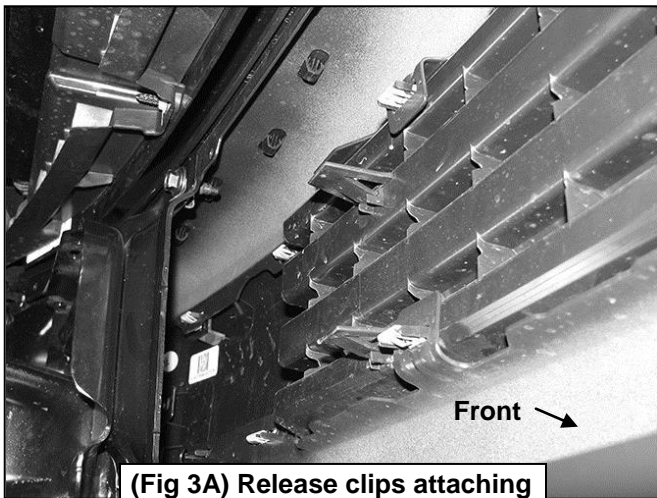

(Fig 3A) Release clips attaching bumper pad to steel bumper

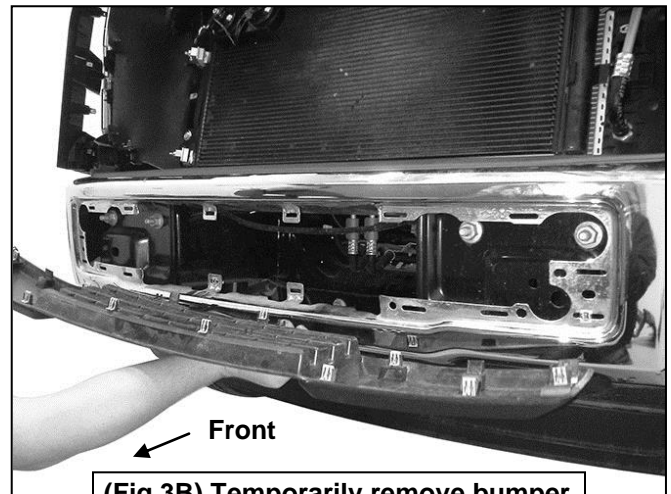

(Fig 3B) Temporarily remove bumper pad. Grille removed for instruction purposes only, do not remove grille



(Fig 4A) 12mm
Double Nut Plate

12mm x 35mm Hex Bolt
12mm Lock Washer
12mm Flat Washer

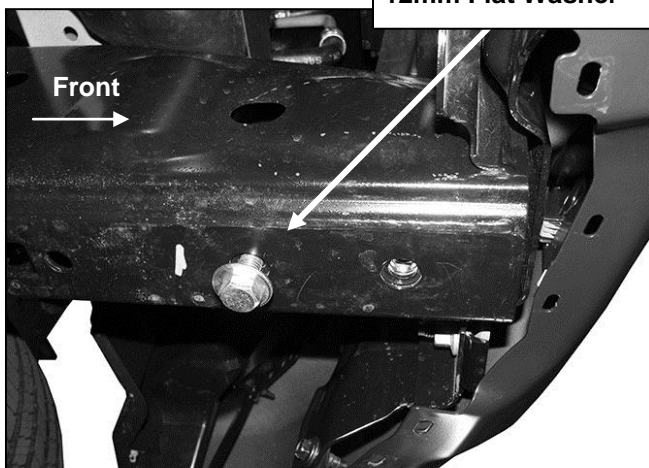

(Fig 5) Use a Hex Bolt to line up the Nut Plate

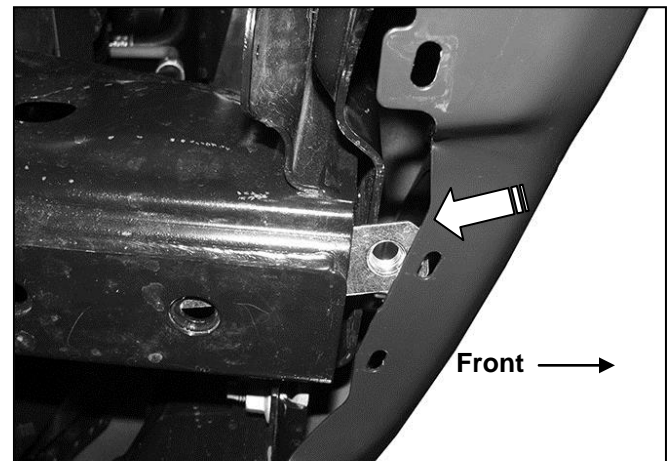

(Fig 4B) Insert Nut Plate into open end of frame- applies to models without tow hooks only

Driver Side Installation Pictured

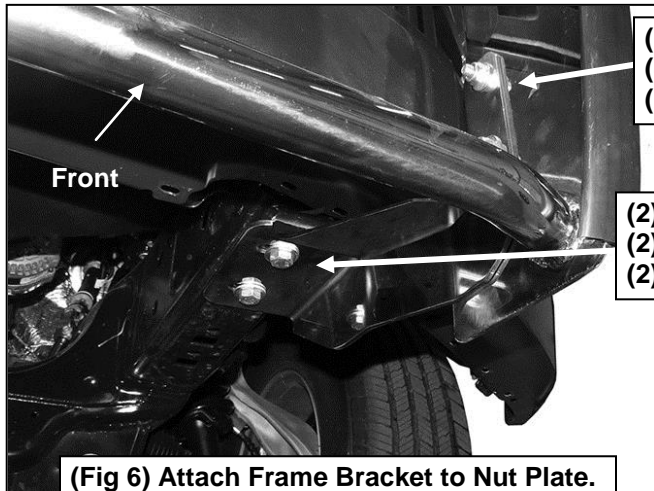

(Fig 6) Attach Frame Bracket to Nut Plate. Grille Guard pictured for reference only

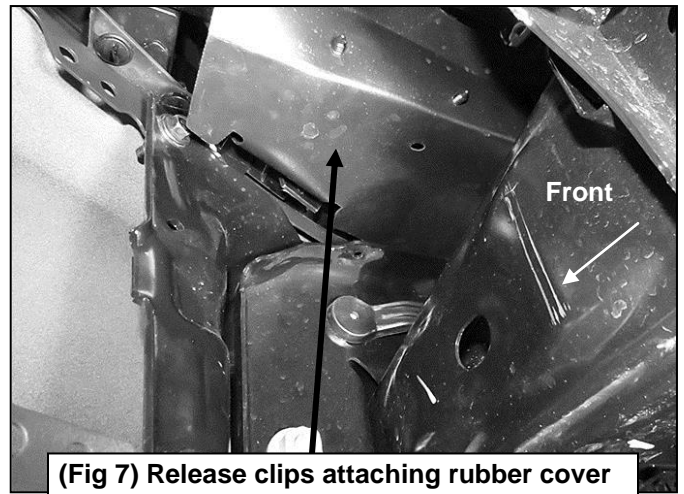

(Fig 7) Release clips attaching rubber cover to back of bumper above bumper brackets

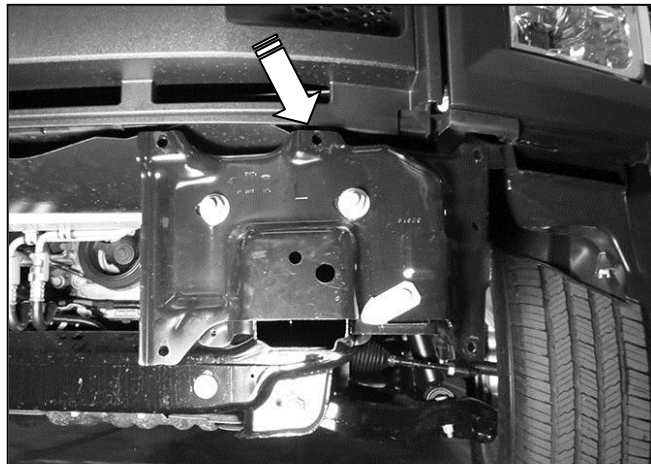

(Fig 8) Locate the top bumper bolts. Remove the driver side middle bolt (see arrow-bumper pictured removed for reference only-do not remove bumper)

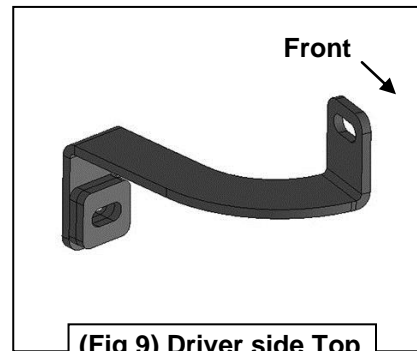

(Fig 9) Driver side Top Bracket illustrated

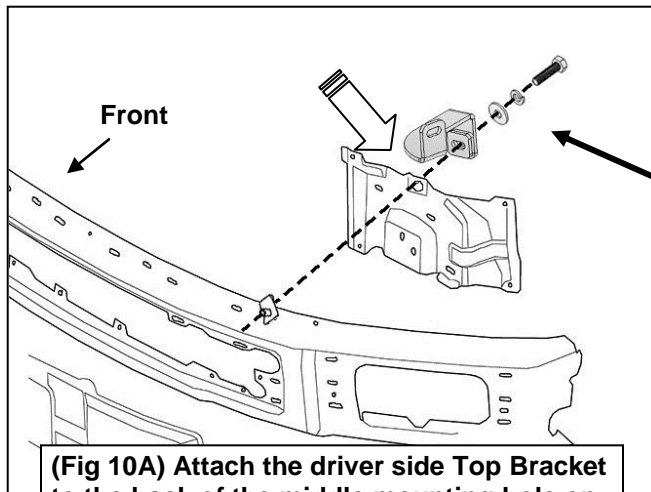

(Fig 10A) Attach the driver side Top Bracket to the back of the middle mounting hole on the top of the bumper bracket

From behind bumper, release clips attaching rubber cover to back of bumper above bumper brackets to access the bumper bolts (Fig 7). Insert the Top Bracket (Fig 9 & 12) into gap between top of bumper and bottom of grille.

Driver Side Installation Pictured

8mm x 40mm Hex Bolt
8mm Lock Washer
8mm Flat Washer

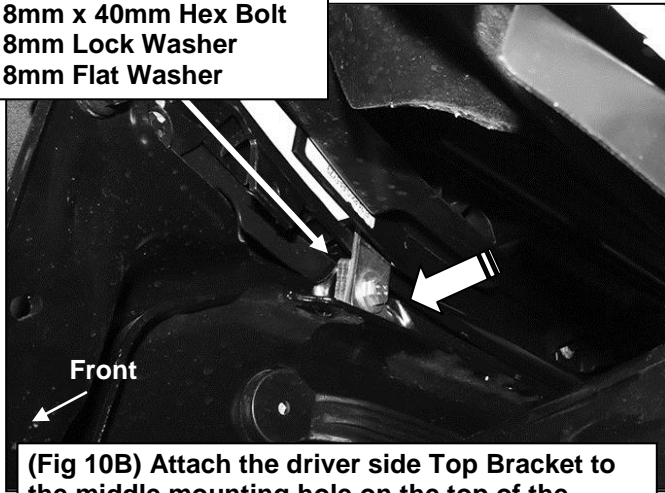

(Fig 10B) Attach the driver side Top Bracket to the middle mounting hole on the top of the bumper bracket (pictured from behind bumper)

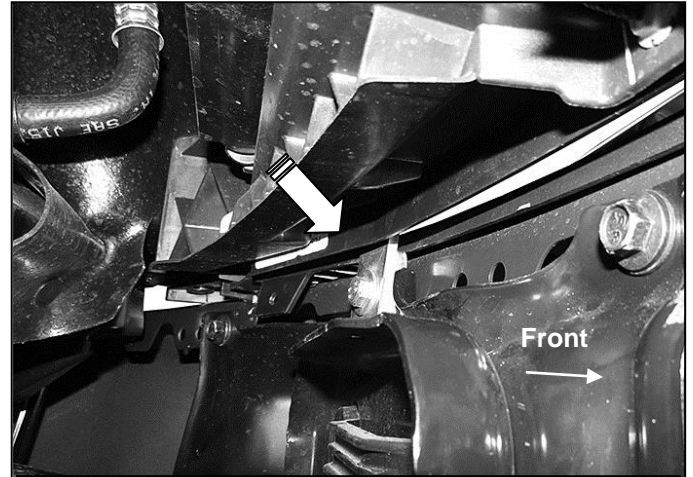

(Fig 10C) Attach the driver side Top Bracket to the middle mounting hole on the top of the bumper bracket (pictured from behind center of bumper)

Do not cut through front or back edge of splash guard

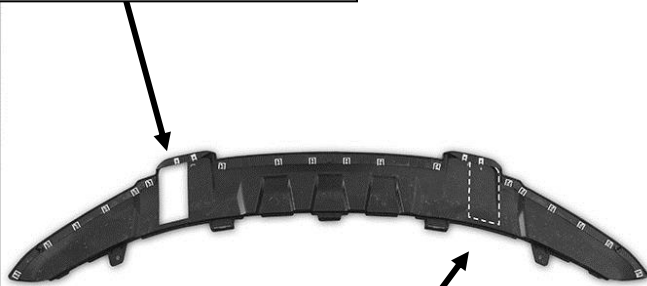

Fig 11) Hold the splash guard up to the bottom of Frame Brackets. Trace location of Brackets onto back of the plastic cover (dashed line). Cut as required to clear brackets

8mm x 30mm Hex Bolt
(2) 8mm Flat Washers
8mm Nylon Lock Nut

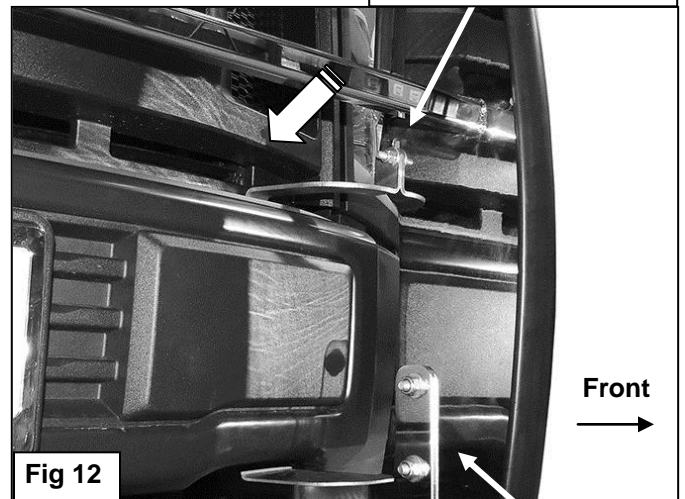

Fig 12

(2) 10mm x 30mm Hex Bolts
(4) 10mm Flat Washers
(2) 10mm Nylon Lock Nuts



Complete Installation