



INSTALLATION INSTRUCTIONS

GRILLE GUARD

2010-15 TOYOTA 4RUNNER

EXCLUDES 2014-15 "LIMITED" MODELS

PART #2066-2/2066

PARTS LIST:

1	Grille Guard	2	8-1.25mm x 30mm Button Head Bolts
1	Driver/Left Frame Mounting Bracket	2	8-1.25mm x 30mm Hex Bolts
1	Passenger/Right Frame Mounting Bracket	6	8mm x 24mm OD x 2mm Flat Washers
2	Top Mounting Brackets (1 L & 1 R) 2010-2013 only	2	8mm x 16mm OD x 1.6mm Flat Washers
2	Top Mounting Brackets (L or R) 2014-on only	4	8mm Nylon Lock Nuts
4	12-1.75mm x 30mm Hex Bolts	2	6-1.0mm x 20mm Button Head Bolts
8	12mm ID x 24mm OD x 2.5mm Flat Washers	2	6mm x 18mm x 1.6mm Flat Washers
4	12mm Lock Washers	2	6mm Lock Washers
4	12mm Hex Nuts	1	50mm x 200mm Adhesive Backed Foam Tape
1	Wrench (8mm button head bolts)	1	Wrench (6mm button head bolts)

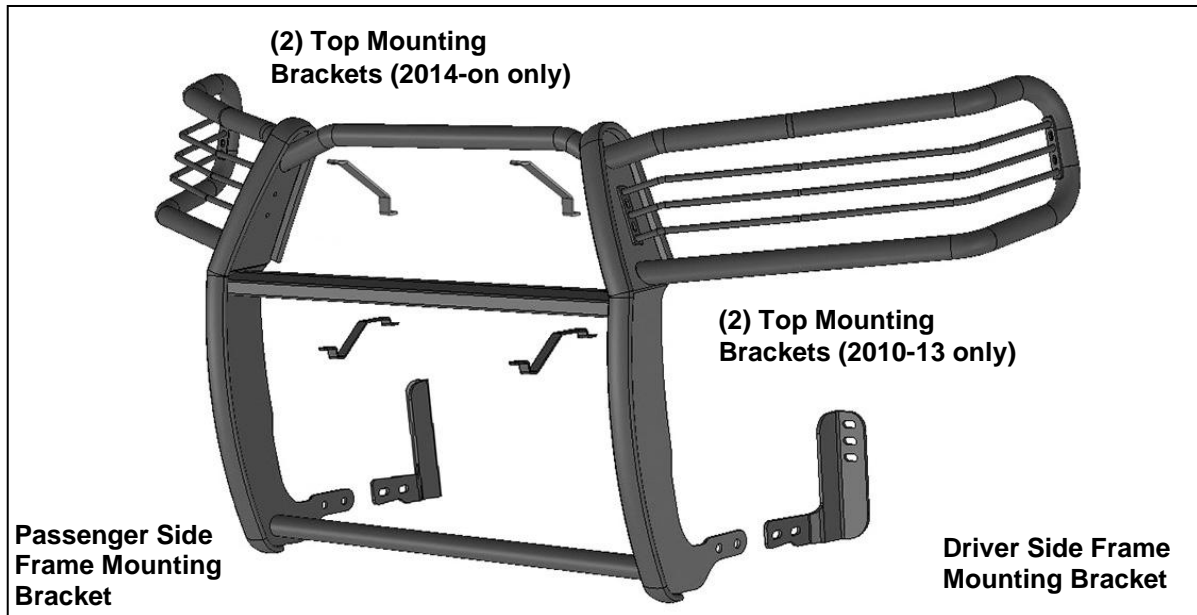

PROCEDURE:

REMOVE CONTENTS FROM BOX. VERIFY ALL PARTS ARE PRESENT. READ INSTRUCTIONS CAREFULLY BEFORE STARTING INSTALLATION. ASSISTANCE IS RECOMMENDED. CUTTING MAY BE REQUIRED. INSTALLATION MAY INTERFERE WITH FRONT SENSORS. NOT RECOMMENDED FOR VEHICLES WITH OPTIONAL "ACTIVE" LASER GUIDED CRUISE CONTROL SYSTEMS.

- Starting on the driver side, remove the (3) factory bumper mount bolts located on the outside of the driver side bumper mount, **(Figures 3 & 5)**.
On 2010-13 models, remove the small driver side and passenger side plastic splash guards and place them on a clean, stable work area, **(Figure 1)**. To make reinstallation easier, note the type and location of all factory fasteners. The plastic center splash guard may also be removed for access to hardware if necessary. **IMPORTANT:** Apply a layer of masking tape to the openings in the bumper to protect the painted finish during bracket installation, **(Figure 2)**.
- Select the driver side Frame Bracket. Line up the (3) slots in the Mounting Bracket with the (3) bolt locations for the factory bumper bracket. Attach the Frame Bracket to the bumper bracket with the (3) factory bolts removed in **Step 1**, **(Figures 5 & 6)**. Snug but do not tighten hardware at this time.
On some 2010-13 models, start with the frame Bracket in a horizontal position, **(Figures 4 & 5)**.
 From behind the bumper, insert the mounting tab on the Bracket into the back of the bumper opening then rotate the Bracket up to the bumper bolts.
- Repeat **Steps 1 & 2** for passenger side Frame Mounting Bracket installation.
- Next, open the hood and remove the plastic cover between the top of the radiator and the grille, **(Figure 7)**. **NOTE:** Pay close attention to the type and location of all factory hardware for easier reinstallation.
- Select the correct Top Bracket installation for your model/year.

2010-13 Models:

- a. Remove the outer plastic clip attaching the bottom of the plastic grille to the top of the steel cross member closest to the outer edge of the grille opening, **(Figure 8)**.
- b. Apply the Adhesive Backed Foam Tape to the underside, (side facing the bumper), on both 2010-13 Top Brackets to prevent damage to the bumper during installation, **(Figure 9)**. **NOTE:** Cut Foam Tape to fit areas that may come in contact with the bumper cover.
- c. Select (1) left or right 2010-13 Top Bracket, **(Figure 9)**. From behind the grille, insert the Bracket through the opening in the grille directly above the hole in the cross member, **(Figures 10 & 11)**. **NOTE:** Inner end of Brackets are offset to one side for plastic grille clearance on various models/years. Select the 2010-13 Bracket that will fit properly through the grille.
- d. Attach the Top Bracket to the cross member with (1) 8mm x 30mm Hex Bolt, (2) 8mm x 24mm x 2mm Flat Washers and (1) 8mm Nylon Lock Nut, **(Figure 10)**. Leave hardware loose.
- e. Repeat the previous Steps to attach the passenger side 2010-13 Top Bracket.

2014-on models:

- a. Remove the inner plastic clip closest to the center grille emblem attaching the bottom of the grille to the top of the cross member, **(Figure 12)**. Select (1) 2014-on Top Bracket, **(Figure 13)**.
 - b. From behind the grille, insert the Bracket through the opening in the grille, **(Figure 14)**.
 - c. Attach the Bracket to the cross member with (1) 8mm x 30mm Hex Bolt, (2) 8mm x 24mm x 2mm Flat Washers and (1) 8mm Nylon Lock Nut, **(Figure 14)**. Leave hardware loose.
 - d. Repeat the previous Steps to install the 2014-on passenger side Top Bracket.
6. Carefully unwrap the Grille Guard. With assistance, line up the bottom mounting tabs on the Grille Guard with the (2) previously installed Frame Brackets. Bolt the Grille Guard to the outside of the Brackets with the included (4) 12mm x 30mm Hex Bolts, (8) 12mm Flat Washers, (4) 12mm Lock Washers and (4) 12mm Hex Nuts, **(Figures 15 & 16)**. Do not tighten hardware at this time.
7. Push the Grille Guard back toward the vehicle. Line up the Top Brackets with the appropriate mounting points on the Grille Guard.

2010-13 models: Attach the outer end of the driver side Top Bracket to the bottom of the center crossbar with (1) 8mm Button Head Bolt, (1) 8mm x 16mm Small Flat Washer (top), (1) 8mm x 24mm Flat Washer (bottom) and (1) 8mm Nylon Lock Nut, **(Figure 17)**. Leave hardware loose at this time. Repeat this **Step** to attach the passenger side Top Bracket to the Grille Guard.

2014-15 models: Attach the outer end of the driver side Top Bracket to the bottom of the top tube on the Grille Guard with (1) 6mm x 20mm Button Head Bolt, (1) 6mm Lock Washer and (1) 6mm Flat Washer, **(Figure 18)**. Leave hardware loose at this time. Repeat this **Step** to attach the passenger side Top Bracket to the Grille Guard.

8. Level and adjust the Grille Guard properly and tighten all hardware. **IMPORTANT:** Do not over-tighten the (2) 8mm Hex Bolts attaching the Top Mounting Brackets to the tab on the plastic grille and cross member or you may damage the grille.
9. On **2010-13** models only, reinstall the plastic center splash guard using the factory hardware if removed in **Step 1**. Select the driver side plastic splash guard and hold it up in position against the bottom of the Mounting Bracket. Mark the area that needs to be removed from the splash guard to clear the Bracket. Check the location carefully and cut only the amount of plastic from the splash guard to clear the Bracket, **(Figure 19)**. Once the slot has been checked for clearance, reinstall the splash guard with the factory hardware. Repeat this **Step** to reinstall the passenger side splash guard.
10. Do periodic inspections to the installation to make sure that all hardware is secure and tight.

To protect your investment, wax this product after installing. Regular waxing is recommended to add a protective layer over the finish. Do not use any type of polish or wax that may contain abrasives that could damage the finish.

For stainless steel: Aluminum polish may be used to polish small scratches and scuffs on the finish. Mild soap may be used also to clean the Grille Guard.

For gloss black finishes: Mild soap may be used to clean the Grille Guard.

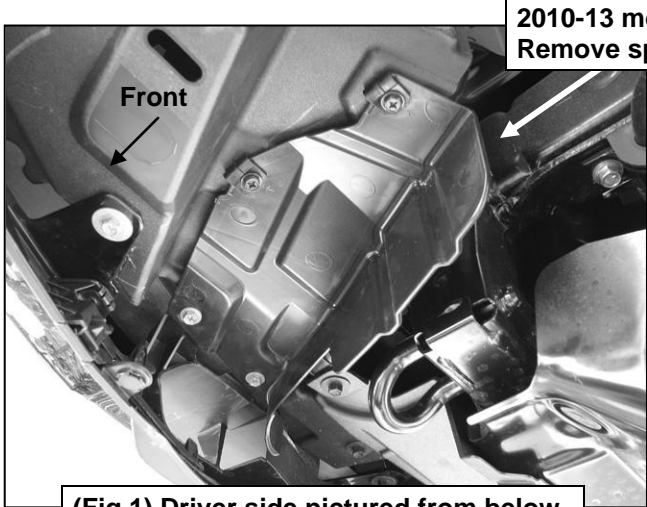

2010-13 models-
Remove splash guard

(Fig 1) Driver side pictured from below

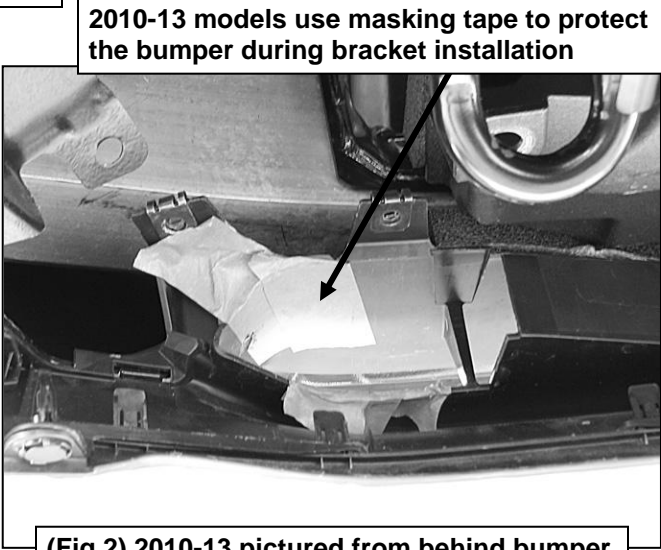

2010-13 models use masking tape to protect
the bumper during bracket installation

(Fig 2) 2010-13 pictured from behind bumper

Remove (3) factory
bumper bracket bolts
(outer bolts only)

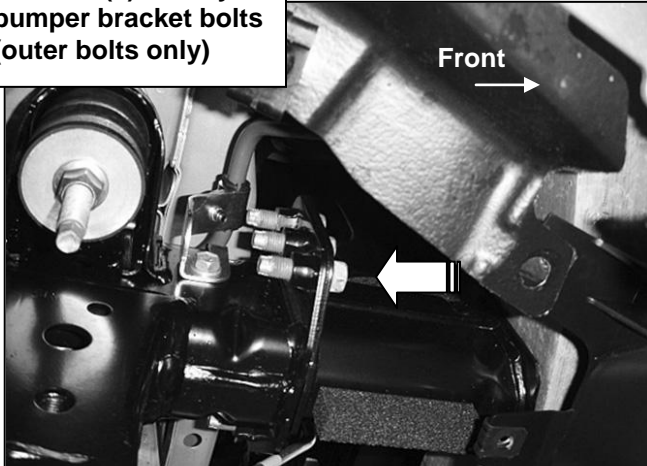

(Fig 3) Passenger side pictured from below vehicle

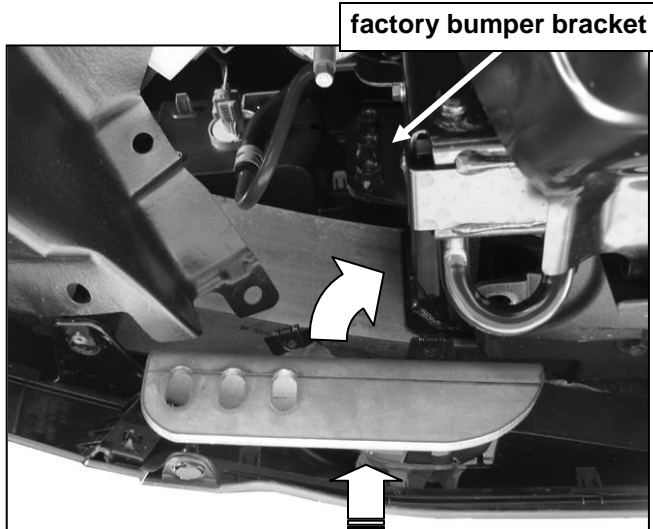

factory bumper bracket

(Fig 4) 2010-13 models, hold Bracket flat and
insert through opening in back of bumper

Line up Frame Bracket and
attach to bumper bracket
with (3) factory hex bolts

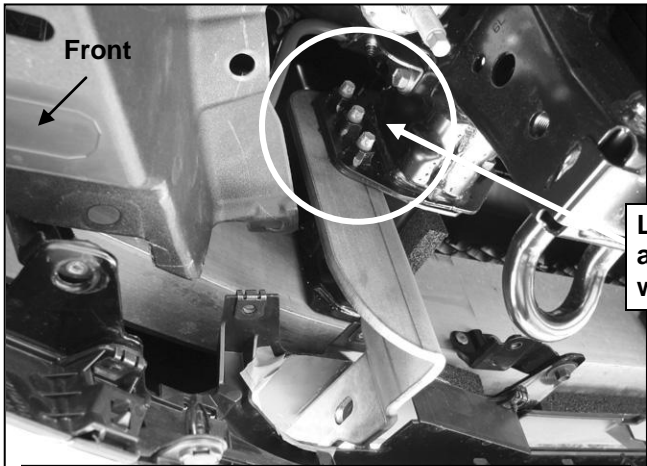

(Fig 5) 2010-13 pictured from behind bumper

Driver Side Installation Pictured



Line up Frame Bracket and attach to bumper bracket with (3) factory hex bolts

(Fig 6) Passenger side 2014-on pictured

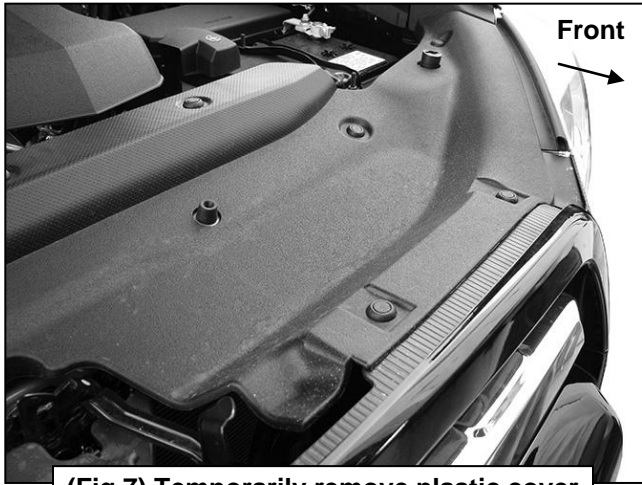

(Fig 7) Temporarily remove plastic cover

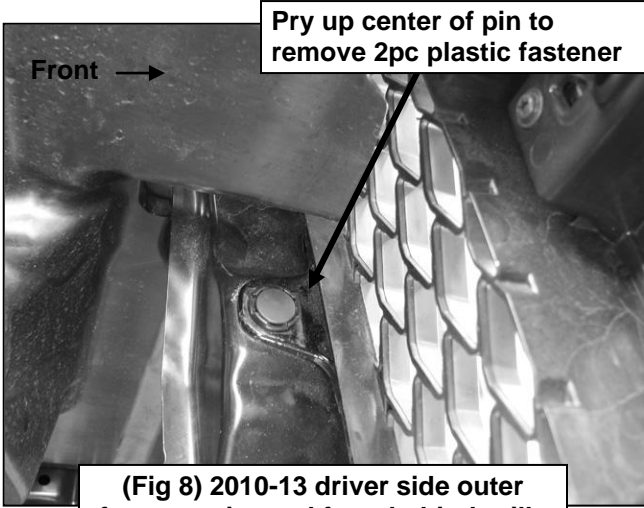

Pry up center of pin to remove 2pc plastic fastener

(Fig 8) 2010-13 driver side outer fastener pictured from behind grille

Apply Adhesive Backed Foam Tape to back of Top Brackets

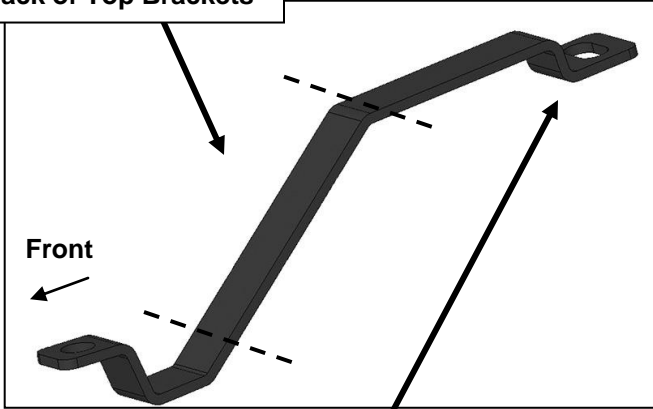

(Fig 9) 2010-13 driver side Top Bracket. Note inner end of Bracket is offset to fit multiple models. Select the Bracket with the best fit through the opening in grille

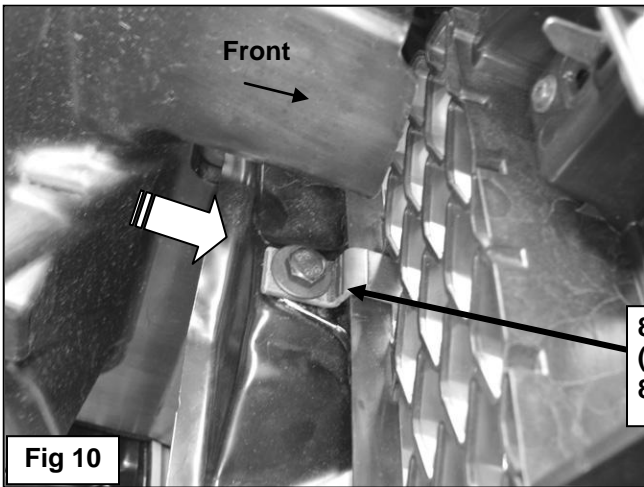

8mm x 30mm Hex Bolt
(2) 8mm x 24mm Flat Washers
8mm Nylon Lock Nut

Fig 10

GRILLE GUARD
 2010-15 TOYOTA 4RUNNER
 EXCLUDES 2014-15 "LIMITED" MODELS

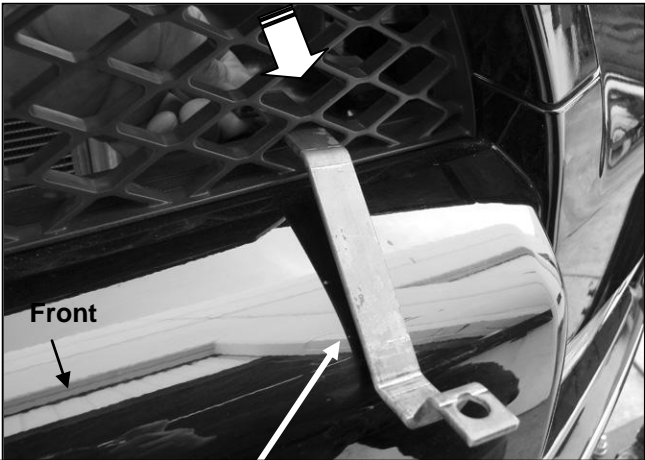

(Fig 11) 2010-13 models: Apply Adhesive Backed Foam Tape to the back of the Top Brackets to prevent damage to bumper cover during installation

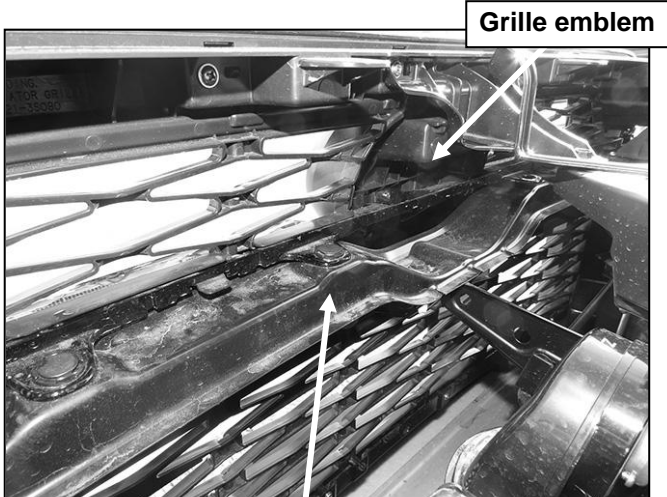

(Fig 12) 2014-on; Remove driver side fastener closest to grille emblem (pictured from behind grille)

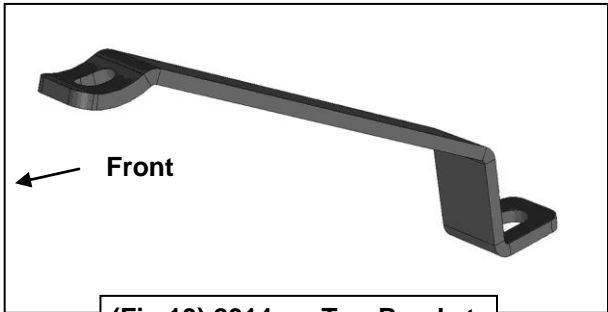

(Fig 13) 2014-on Top Bracket

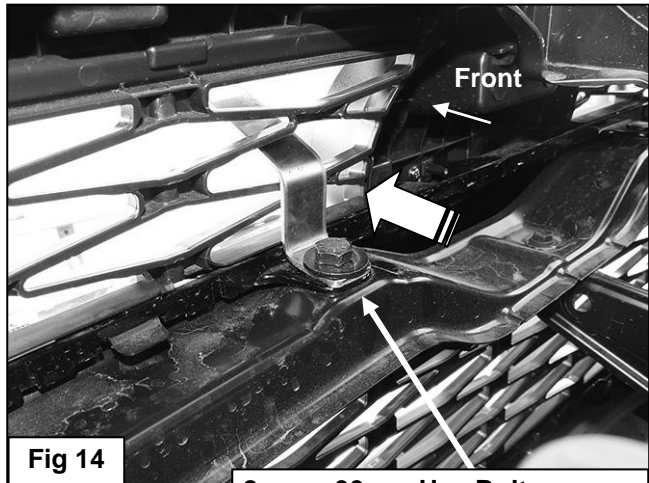
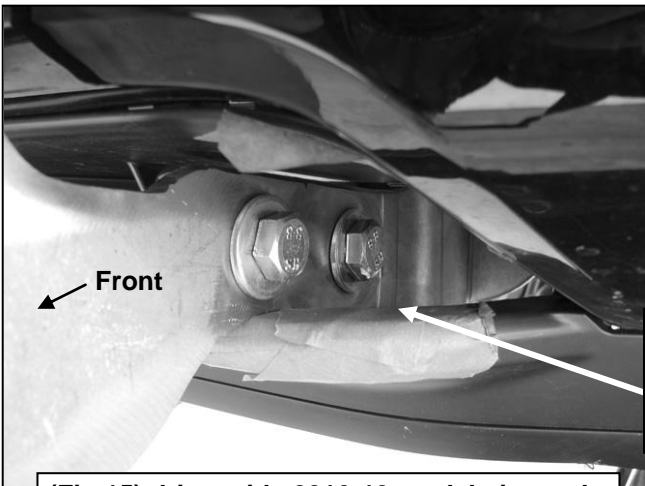

Fig 14

- 8mm x 30mm Hex Bolt
- (2) 8mm x 24mm Flat Washers
- 8mm Nylon Lock Nut



(Fig 15) driver side 2010-13 model pictured

- (2) 12mm x 30mm Hex Bolts
- (4) 12mm Flat Washers
- (2) 12mm Lock Washers
- (2) 12mm Hex Nuts

GRILLE GUARD
2010-15 TOYOTA 4RUNNER
EXCLUDES 2014-15 "LIMITED" MODELS

- (2) 12mm x 30mm Hex Bolts
- (4) 12mm Flat Washers
- (2) 12mm Lock Washers
- (2) 12mm Hex Nuts

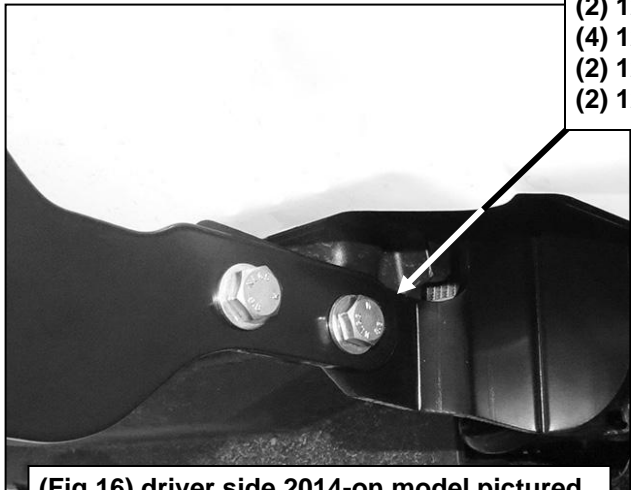

(Fig 16) driver side 2014-on model pictured

- 8mm Button Head Bolt
- 8mm x 16mm Flat Washer (top)
- 8mm x 24mm Flat Washer (bottom)
- 8mm Nylon Lock Nut

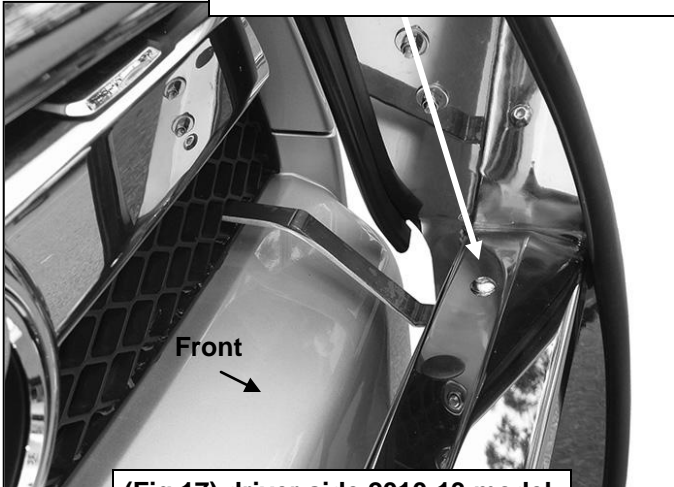

(Fig 17) driver side 2010-13 model

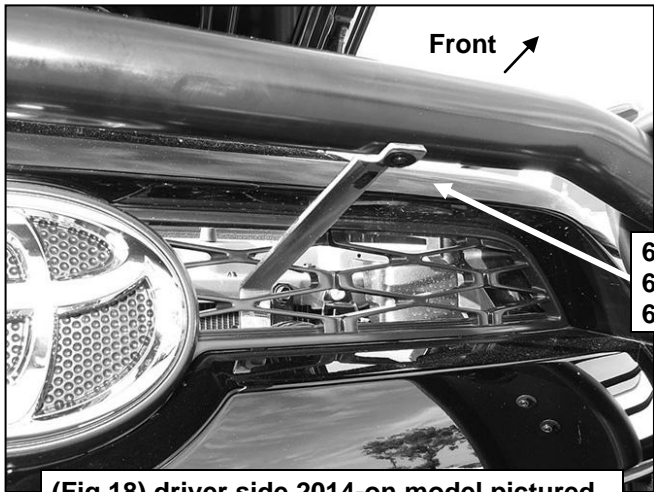

(Fig 18) driver side 2014-on model pictured

- 6mm Button Head Bolt
- 6mm Lock Washer
- 6mm Flat Washer

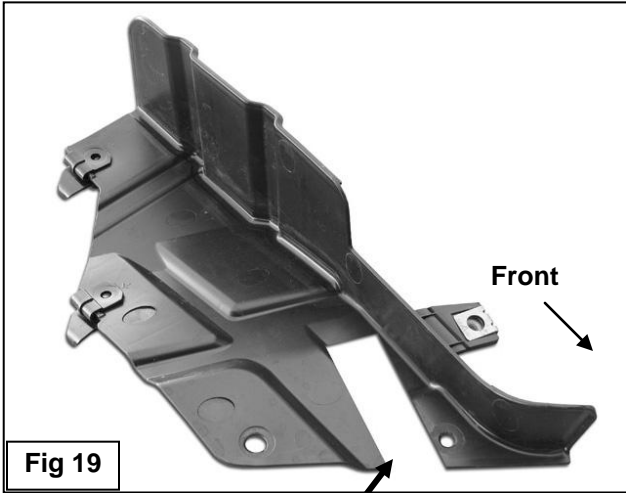

Fig 19

2010-13 model cut out area illustrated for example only



Complete Installation