



# INSTALLATION MANUAL

## CENTER SECTION

### Level of Difficulty

Moderate

This is the first of two manuals required to complete this installation. The second manual is included with your bumper corners. If installing a brush guard, there will be a third manual required.

### Center Section Parts List

1	TrailChaser™ center section
8	Hex bolt, M12
16	Flat washer, M12
8	Lock washer, M12
8	Nut, M12

### Tools Required

Ratchet	Phillips screwdriver
Socket extension	Flathead screwdriver
Socket set	Allen wrench set
Level	Box wrench set

### Torque Specifications

M6 bolt	7 ft-lbs.
M8 bolt	16 ft-lbs.
M10 bolt	33 ft-lbs.
M12 bolt	58 ft-lbs.

Use above torque setting unless otherwise noted

### Product Photo (center section only)

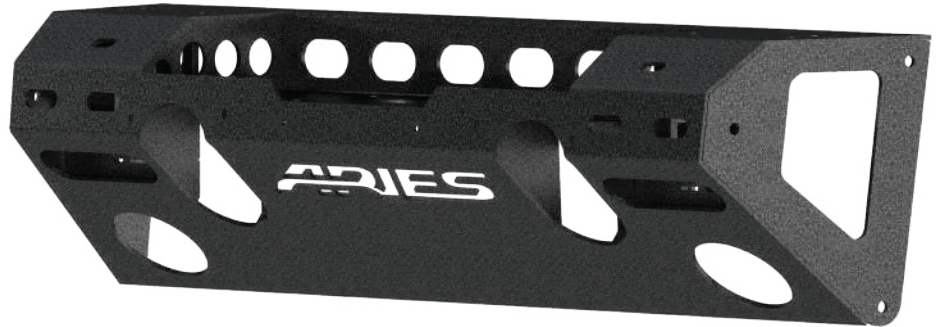

### Applicable to the Following Part Numbers

2081004

2081003

### Notes and Maintenance

Before you begin installation, read all instructions thoroughly.

Proper tools will improve the quality of installation and reduce the time required.

Mild automotive detergent may be used to clean the product. Do not use dish detergent, abrasive cleaners, abrasive pads, wire brushes or other similar products that may damage the finish.

Refer to the table to the left when securing hardware during the installation process to help prevent damage to the product or vehicle.

### Product Registration

CURT Group stands behind our products with industry leading warranties.

At CURT Group, customer is king. We value your feedback and we use that information to make improvements on our products. Please, take a minute and let us know how we are doing.

### Step 1

Remove the front fascia by removing the eight plastic push fasteners from the upper edge of the lower front fascia. Using a socket, remove the two 5mm screws securing the lower edge of the plastic fascia.

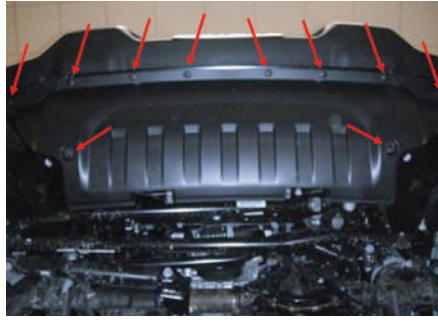

### Step 2

From behind the factory bumper on the passenger side, disconnect the fog light wiring harness.



### Step 3

On the driver side, remove the four nuts securing the factory bumper in place.

Repeat this step on the passenger side.

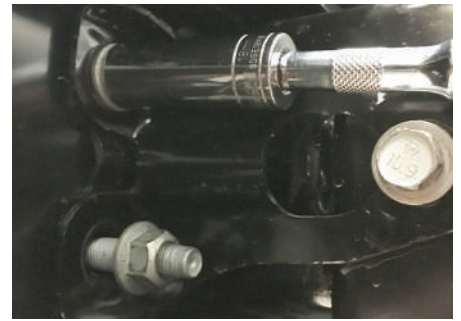
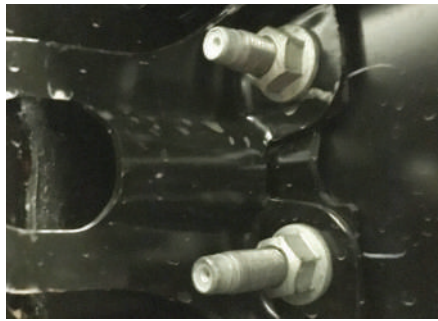

### Step 4

Once all of the bolts have been removed, carefully lift the factory bumper from the frame and set it on a flat work surface.



## Step 5

On the driver side, remove the plastic cover over the factory fog light. Remove the fog light and plastic housing from the factory bumper.

Disconnect the wiring harness from the fog light. Remove the factory fog light from the plastic housing.

Repeat this step on the passenger side.

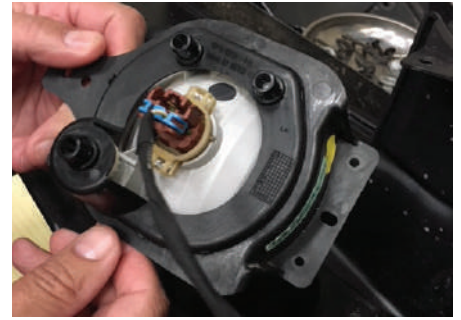

## Step 6

Remove the fog light wiring harness from the factory bumper. Begin by removing the retainer clips from the eight bumper mounting studs.

Remove the four bolts securing the beam to the bumper. Lift the beam from the bumper, exposing the fog light harness.

Remove the plastic push fasteners securing the wire harness to the bumper. The harness will be used on the new bumper.

**Note:** To continue the installation, refer to the installation manual included with your bumper corners. Refer to the installation manual supplied with any additional accessories after the corners have been installed, prior to mounting the bumper to the vehicle.

With your corners and additional accessories (if applicable) installed, continue to Step 7 to complete the bumper installation.

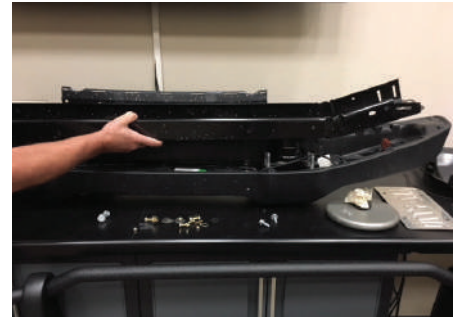

## Step 7

Install the factory fog lights into the new bumper. Be sure to fully engage the plastic push fasteners on the factory fog light into the mounting holes on the bumper.



### Step 8

With assistance, lift the bumper into place over the factory mounting locations.

Attach the bumper using M12 bolts, flat washers, lock washers and hex nuts on all eight mounting locations.

Snug the hardware, but do not fully tighten.

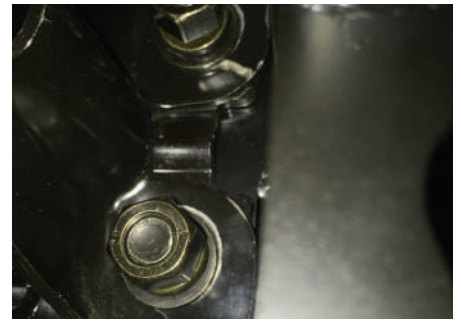

### Step 9

Connect the fog light harness to the fog lights in the bumper.

From behind the bumper on the passenger side, reconnect the fog light wiring harness.



### Step 10

Level and adjust the bumper to the desired position and tighten all hardware to the recommended torque specifications listed in the table on the first page.

**Note:** If installing a bumper with corners that include turn signals, refer to step 12 on the installation included with your bumper corners.

Congratulations on the installation of your new ARIES TrailChaser™ bumper.

With the bumper installed, periodic inspections should be performed to ensure all mounting hardware remains tight.

To protect your investment, see the 'Notes and Maintenance' section on the first page of this instruction manual.





# INSTALLATION MANUAL

## CORNER WITH LEDS

### Level of Difficulty

Easy

This is the second of two manuals required to complete this installation. The first manual is included with your center section. If installing a brush guard, there will be a third manual required.

### Parts List

1	Driver / left corner
1	Passenger / right corner
8	Socket cap screw, M6
8	Flat washer, M6
8	Nylock nut, M6
6	Hex bolt, M10
12	Flat washer, M10
6	Lock washer, M10
6	Nut, M10
2	LED work light (#1501250)
1	Rubber gasket

### Tools Required

Ratchet	Phillips screwdriver
Socket extension	Flathead screwdriver
Socket set	Allen wrench set
Level	Box wrench set

### Torque Specifications

M6 bolt	7 ft-lbs.
M8 bolt	16 ft-lbs.
M10 bolt	33 ft-lbs.
M12 bolt	58 ft-lbs.

Use above torque setting unless otherwise noted

### Product Photo

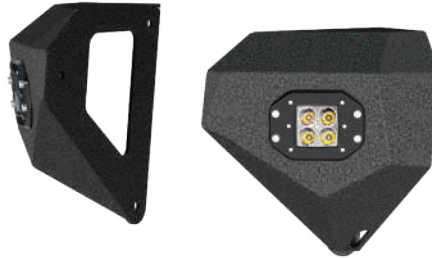

### Applicable to the Following Part Numbers

2081205	2081200
---------	---------

### Notes and Maintenance

Before you begin installation, read all instructions thoroughly.

Proper tools will improve the quality of installation and reduce the time required.

Mild automotive detergent may be used to clean the product. Do not use dish detergent, abrasive cleaners, abrasive pads, wire brushes or other similar products that may damage the finish.

Refer to the table to the left when securing hardware during the installation process to help prevent damage to the product or vehicle.

### Product Registration

CURT Group stands behind our products with industry leading warranties.

At CURT Group, customer is king. We value your feedback and we use that information to make improvements on our products. Please, take a minute and let us know how we are doing.

### Step 1

Set the corners onto a flat work surface. Insert the rubber gasket and LED light into place as shown.

Secure the four LED light attachment points with an M6 socket cap screw, flat washer and nylock nut at each point.

Tighten all hardware and repeat for the second corner and light.

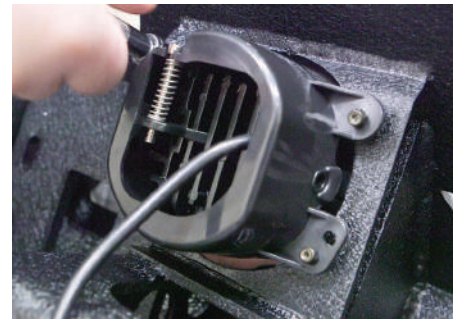
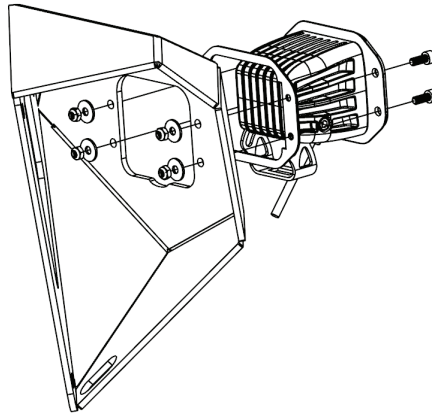

### Step 2

Place the center section onto a flat work surface. Lift the bumper corner into place and insert an M10 hex bolt, lock washer and flat washer. Secure the bolt with a second flat washer and a hex nut.

Repeat this step for all three attachment points.

Snug the hardware, but do not fully tighten.

Repeat this step on the opposite side.



### Step 3

With both corners loosely installed, check to make sure the edges of the bumper corners and center section align.

Adjust if necessary and fully tighten all hardware with a 16mm socket and wrench.

**Note:** If installing a brush guard, refer to the brush guard installation manual at this time.

**Note:** If you are not installing a brush guard, continue to step 7 of the manual included with your center section.

