

ARB FITTING INSTRUCTIONS

ARB TACOMA COMBO BULL BAR 2005 ONWARDS.

- **PART No 3423030**

WARNING

FOR VEHICLES EQUIPPED WITH SRS AIRBAG
WHEN INSTALLED IN ACCORDANCE WITH THESE INSTRUCTIONS, THE FRONT PROTECTION BAR DOES NOT AFFECT OPERATION OF THE SRS AIRBAG.

TAKE NOTE OF THE FOLLOWING:

- **THIS PRODUCT MUST BE INSTALLED EXACTLY AS PER THESE INSTRUCTIONS USING ONLY THE HARDWARE SUPPLIED.**
- **IN THE EVENT OF DAMAGE TO ANY BULL BAR COMPONENT, CONTACT YOUR NEAREST AUTHORISED ARB STOCKIST. REPAIRS OR MODIFICATIONS TO THE IMPACT ABSORPTION SYSTEM MUST NOT BE ATTEMPTED.**
- **DO NOT USE THIS PRODUCT FOR ANY VEHICLE MAKE OR MODEL, OTHER THAN THOSE SPECIFIED BY ARB.**
- **DO NOT REMOVE LABELS FROM THIS BULL BAR.**
- **THIS PRODUCT OR ITS FIXING MUST NOT BE MODIFIED IN ANY WAY.**

Tools Required For Bar Fitment: Basic Tool Kit, ½” socket set , Cir-Clip pliers, Drill, 10mm bit and ¼” socket set

USE.	PART NO.	QTY	DESCRIPTION
Chassis Mount Assembly	3756781	1	Bracket Mount Assembly
	3756794L	1	Bracket Tension LHS
	3756794R	1	Bracket Tension RHS
	6151095	4	Bolt M12 x 1.25 x 35mm
	6151135	4	Nut M12 x 1.25
	4516049	6	Washer Flat ½"
	4581050	6	Washer Spring ½"
	4581007	6	Washer Flat M12 x 4mm HD (Large)
	6151104	2	Bolt ½"x 4"UNC
	6151139	2	Nut ½'UNCNut M10 x 1.25
	6151133	2	Nut M10 x 1.25
	4581040	10	Washer Flat M10
	4581048	6	Washer Spring M10
	6151232	4	Bolt M10 x 1.5 x 30mm
6151026	4	Nut M10 x 1.5	
Bull Bar To Chassis Mount Assembly	6151304	6	Nut Cage M10 x 1.5
	6151232	10	Bolt M10 x 1.5 x 30mm
	4581040	14	Washer Flat M10 x 2mm
	4581048	10	Washer Spring M10
	6151026	4	Nut M10 x 1.5
Stone Tray to Bull Bar	6542063	1	Stone Tray
	6151300	8	Nut Cage 6mm
	6151180	8	Bolt M6 x 20mm
	4581072	8	Washer Flat M6
	4581036	8	Washer Spring M6
Buffers To Bull Bar	3162470R	1	Buffer Standard RHS
	3162470L	1	Buffer Standard LHS
	6151128	12	Nut Flange M6
Indicators To Bull Bar	6821151R	1	Indicator Kit, RHS
	6821151L	1	Indicator Kit, LHS
	6821116	4	Nylon Plug
	6151308	4	Screw, Self Drilling
	6821152	2	Wiring Loom
	180701	6	Scotch Lock
Licence Plate To Bull Bar	6151128	4	Nut Flange M6
	6151046	4	Washer Flat M6
	6151180	4	Bolt M6 x 20mm
	3751313	1	Bracket Number Plate
Miscellaneous	EG50	2	Rubber Grommet 3/8" ID
	180302	10	Cable Ties
	BLB850	3	Cable Black 850mm
	6151074	4	3/8" x 13/4" UNC Bolts

Bracket Control Box to Bull Bar	3751564	1	Bracket control box mount
	6151021	2	Bolt M8 x 20mm
	4581044	2	Washer Flat M8
	6151132	2	Nut Flange M8



1. Remove front bumper cover from vehicle.
2. Remove side bumper supports from both guards.



3. It is recommended that you paint satin black under guard line.

Photo is of RHS of vehicle.

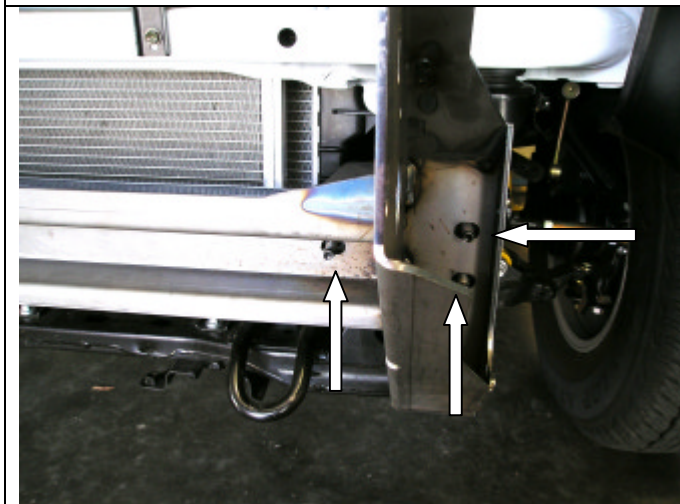

4. Fit bracket mounting assembly to front of vehicle using the 6 x 10mm studs to locate on.

**ARROWS INDICATE STUDS
ON LHS OF VEHICLE**

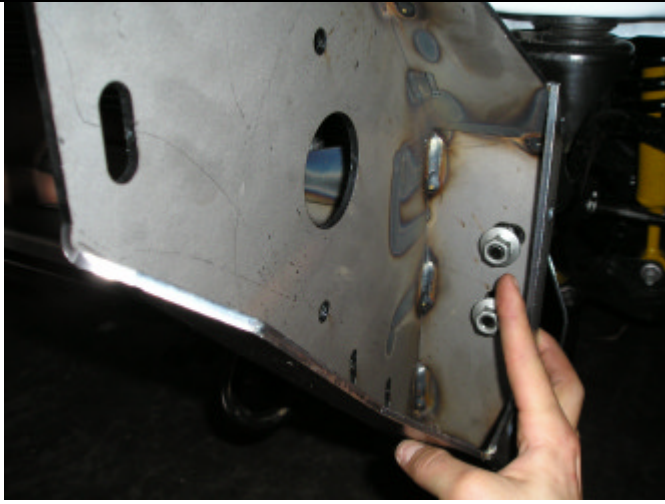

5. Fit original 10mm nuts to the outside fixing points . **See Photo:**



6. Fit 10mm x 1.25mm nuts (fine thread) spring washers and flat washers (from bull bar bolt kit) to both the centre studs. **See Photo:**

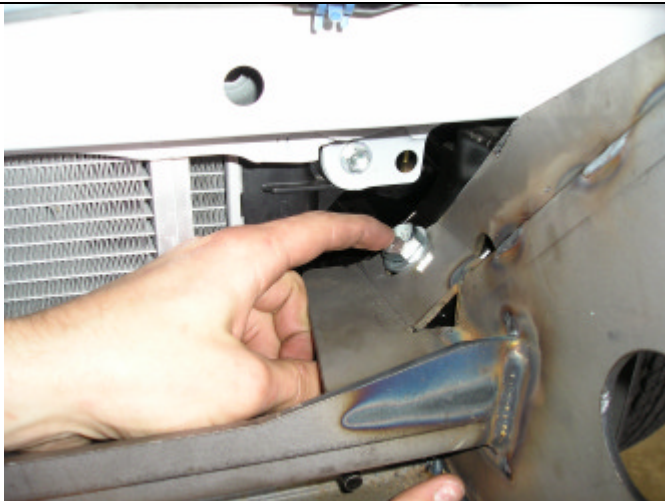

7. Fit 12 x 35mm x 1.25 (fine thread) bolt, 12mm flat washer through top rearward bracket passing through body mount.

See Photo:

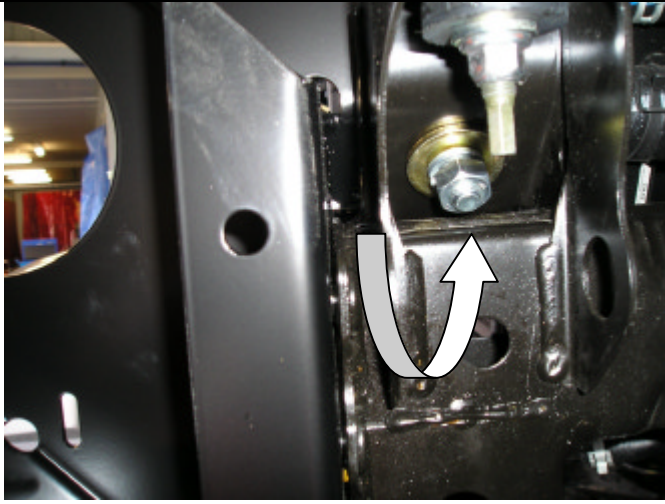

- Secure from underneath using large 12mm gold coloured flat washer, 12mm spring washer and 12mm nut to both sides of vehicle.

See Photo:

**PHOTO VIEWED FROM UNDER
LHS OF VEHICLE**

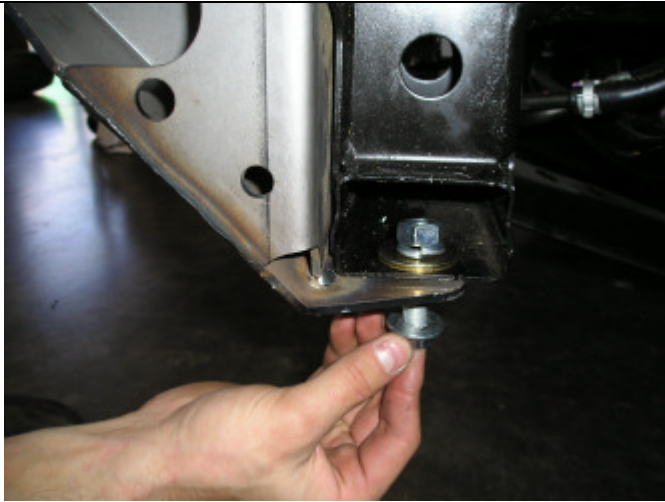

- Secure lower fixing point by passing through lower bracket in a upward motion, using M12 bolt, 12mm flat washer and secure from the top using large gold coloured 12mm flat washer, 12mm spring washer and 12mm nut (fine thread) to each side of vehicle. When all bolts are fitted, tighten securely.

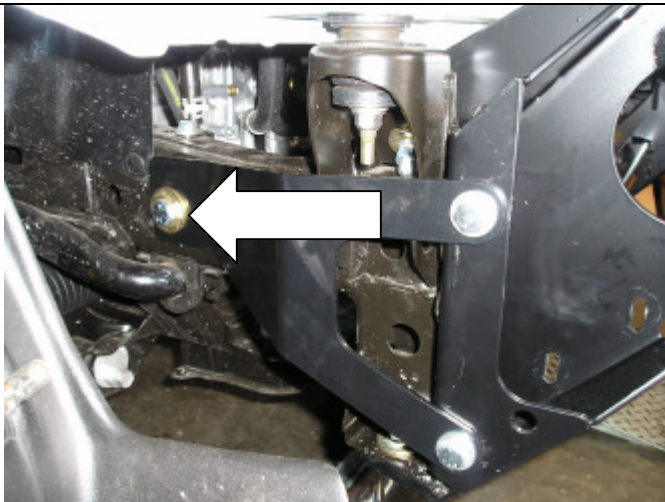

PHOTO IS OF RHS OF VEHICLE

- Lastly fit tension brackets to each side of vehicle. The two front fixing bolts are M10 x 30mm, flat washers, spring washers and M10 nuts. The rear bolt is 4" x 1/2" which is passed through the chassis from outside of vehicle and fitted with a large gold 12mm washer and a 1/2" Nyloc nut on the inside of vehicle. When all bolts are fitted, tighten front 10mm bolts securely and tighten rear 1/2" bolt to a torque setting of 30ft lb (**NO MORE**)

ARROW INDICATES THE 1/2" BOLT



11. If vehicle is fitted with fog lights, remove globes from sockets and cable tie fog light loom to vehicle panel.

ie There is no provision for fog lights in the bull bar

PHOTO IS LHS OF VEHICLE

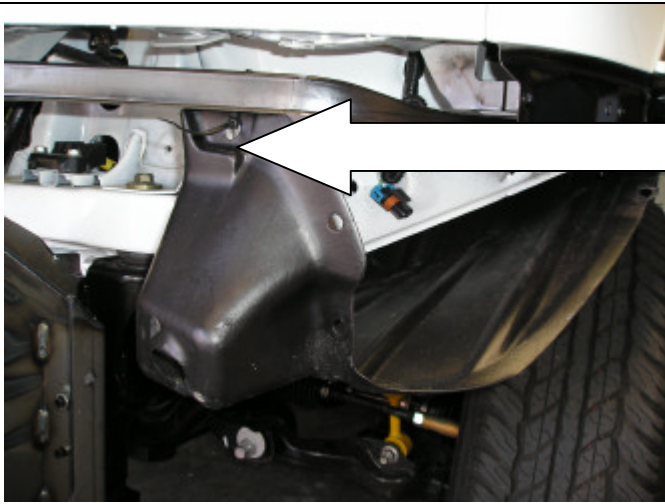

12. Cable tie under guard plastic moulding up to vehicle front pan.

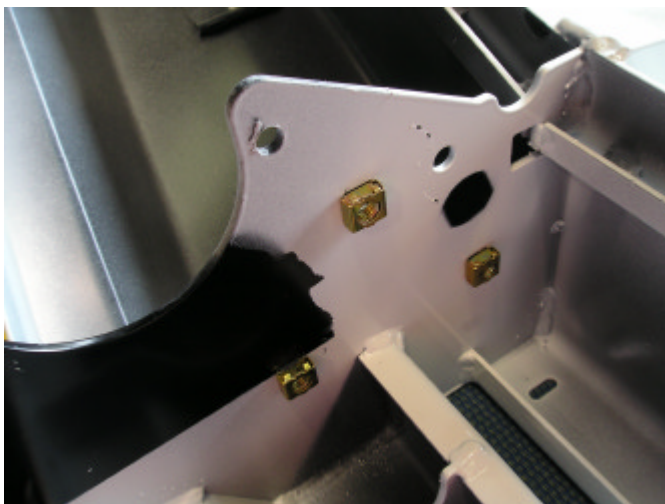

13. Fit M10 caged nuts to the inside of mounting surface of bull bar.

(3 to each side of bull bar.)

PHOTO IS OF INSIDE LHS OF BULL BAR.



14....Fit white nylon plugs into square holes.

PHOTO IS OF INSIDE LHS OF BULL BAR.

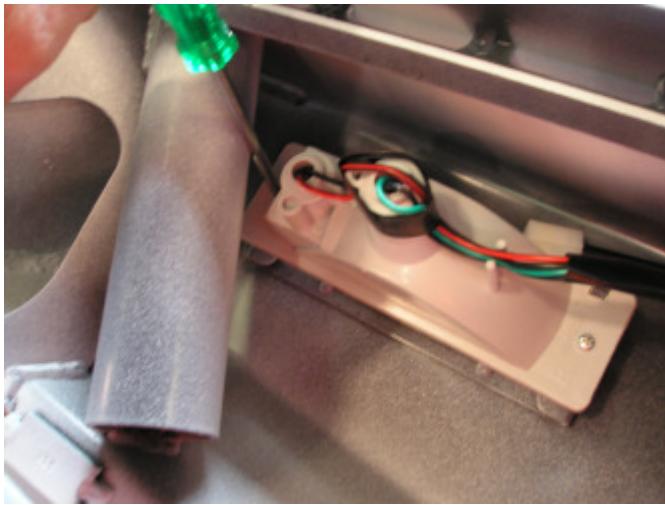

15. Align indicator/parker light above white nylon plugs and secure to bull bar using self tapping screws.

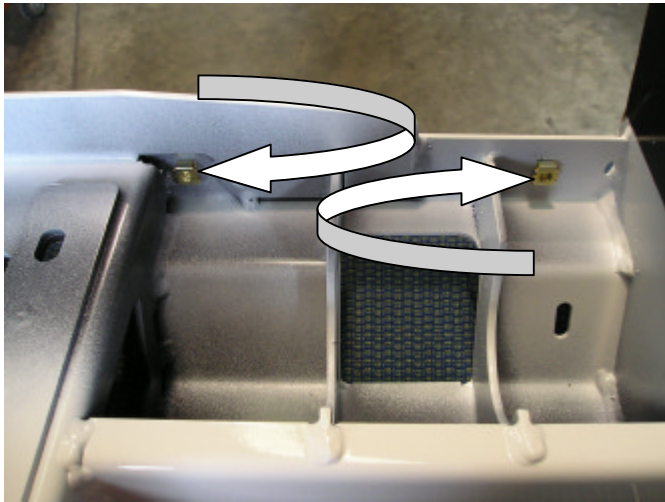

16 .Fit M6 caged nuts to inside lower flange of inside of bar.

17..Fit two to each side.

THESE CAGED NUTS ARE TO BOLT ON SPLASH PAN.

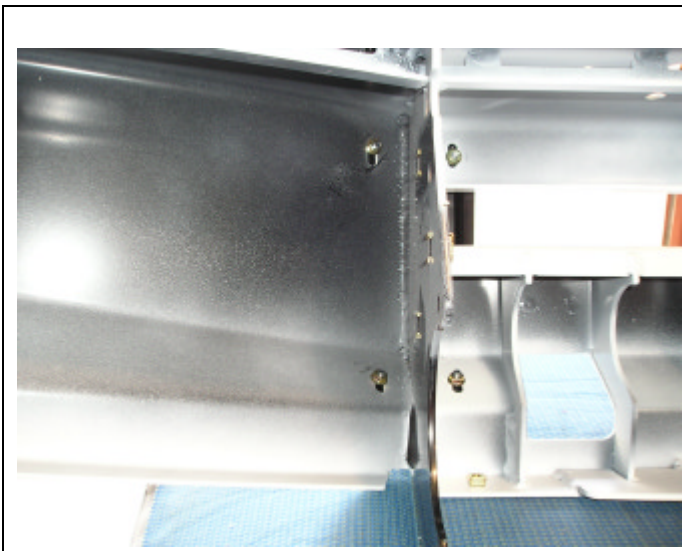

18. Fit buffers to bar and secure from inside of bull bar using 6mm flange nuts. Six to each side of vehicle.

DO NOT OVER TIGHTEN

TO FIT A WINCH BAR

19. To fit an 8/9/9.5/000lb winch, rotate gearbox 72° counterclockwise.

Stand winch upright and undo the capped head screws and by lifting the gearbox only a couple of millimetres, rotate the gearbox. Once in position, refit all screws and tighten firmly.

WARNING: Do not lift gearbox more than a couple of millimeters.

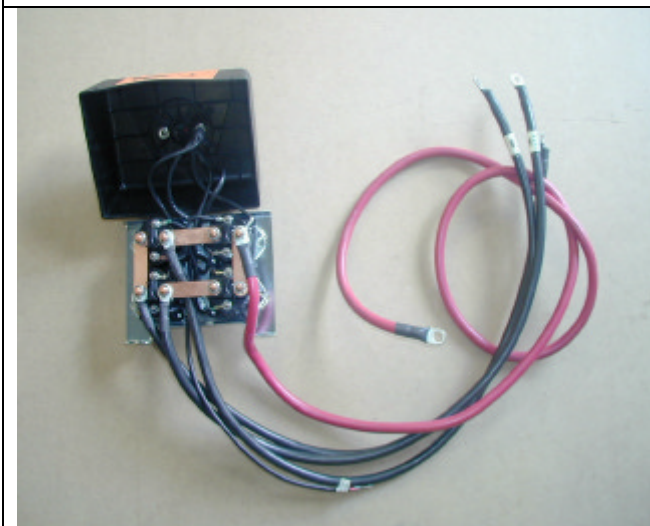
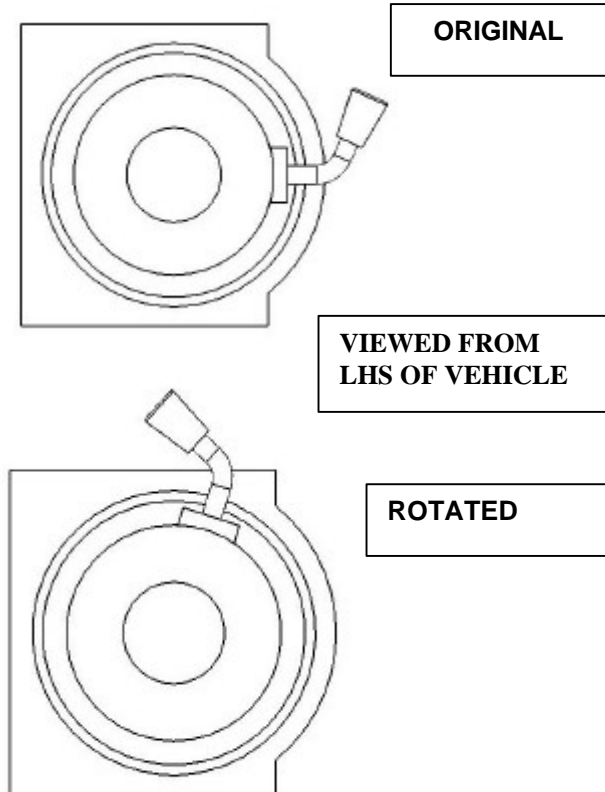

20. Remove the cover from the control box.

21. Replace the three main power cables that go from winch to control box. Make sure that you identify the colour codes on the new cables before closing control box cover.

This must be done for whatever winch is to be fitted to the bull bar.

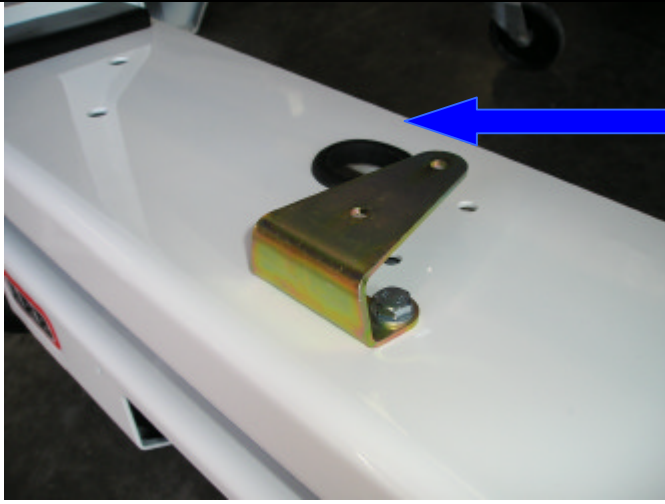

22. Bolt control box bracket to top of bar using 8mm hardware.
23. Fit rubber grommet to RHS of bar.

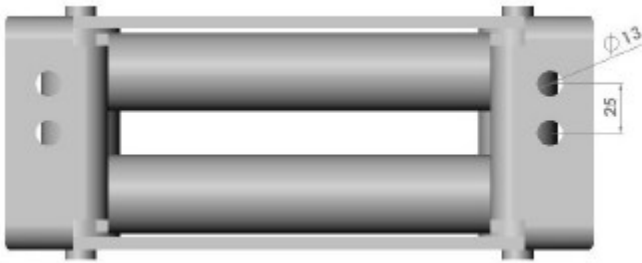

24. Drill two new 13mm holes in the roller fairlead provided in the kit, as shown on the adjacent picture.

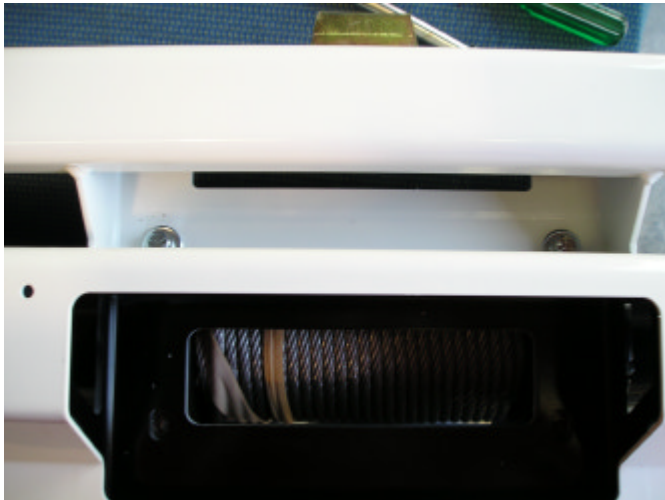

25. Place the winch on a table with the feet facing up and using an assistant; carefully lift the bull bar on top of the winch.
26. Attach the winch to the bull bar using two 1 1/2" x 3/8" bolts from the winch fitting kit, 3/8" spring washer and 3/8" flat washers in the top holes.



27. Position the roller fairlead, and remove the circlips from the lower of the verticle rollers and push the pins up to give access to the lower bolts.

28. Fix the roller fairlead to the bar using the 1 3/4" x 3/8" bolts, spring and flat washers.



29. When all bolts are fitted and tighten, refit vertical roller pins back into roller fairlead and refit circlips.

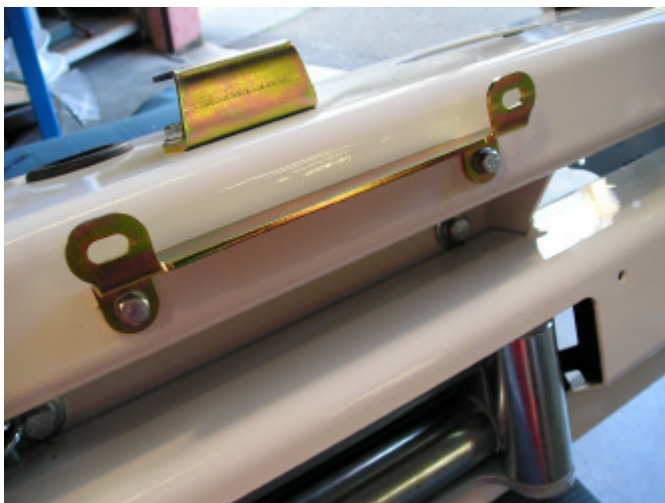

30. Fit number plate bracket to bar using 6mm hardware.



31. Fit control box to control box bracket and pass cables through rubber grommet.



32. Fit all 3 cables to their correct terminals and tighten. Refer to Warn installation instruction when wiring up winch. Fit plastic boots over terminals. Cable tie cables to brace as per photo to clear of all moving parts. Fit ground wire under winch tie rod. (See Photo)

GROUND WIRE

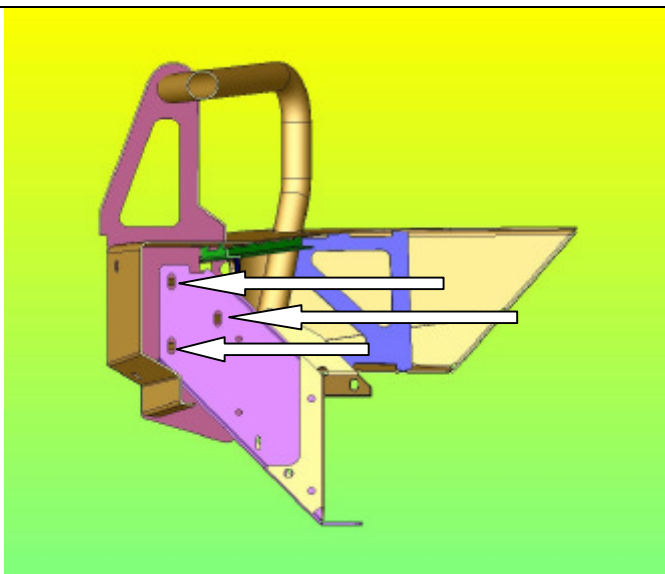

33. With the help of a friend, lift bull bar on to chassis mount bracket and align holes with 10mm caged nuts already fitted. (3 each side)

34. Secure using M10 x 30mm bolt, M10 spring washer and M10 flat washer.

ARROWS INDICATE WHICH HOLES TO USE IN SECTION VIEW DRAWING

SECTION VIEW IS LHS OF VEHICLE.



35. Align bull bar so there is a 15mm to 20mm gap around periphery under front vehicle panels, then tighten all bolts securely.

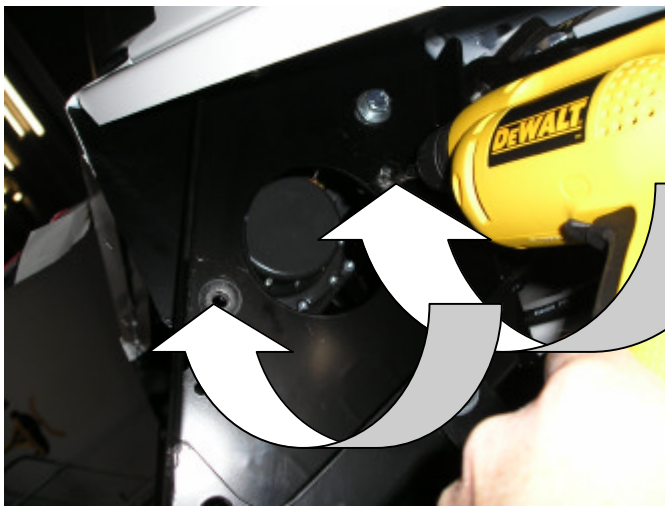

36. Finally, using the existing 2 holes as a template. Drill through using a M10 drill bit and secure using the balance of the 10mm hardware.

(These bolts are to lock the bull bar to the chassis mounting bracket)

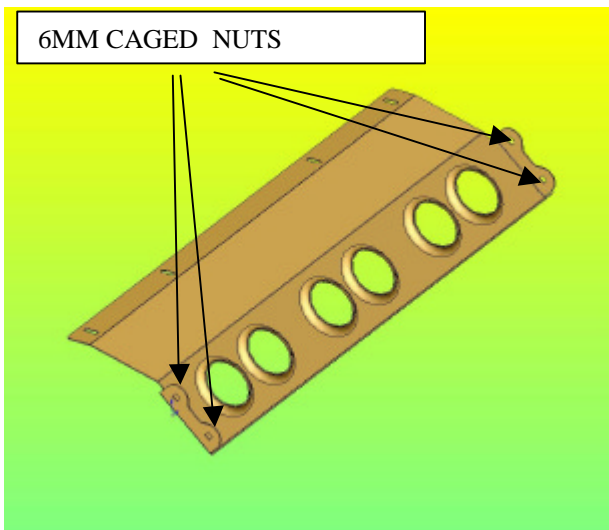

37. Fit M6 caged nuts to the inside of the flanges on the splash pan.



38. Fit splash pan to lower flange of bull bar using M6 x 20mm bolts, 6mm spring washers and 6mm large flat washers. Finger tighten only.

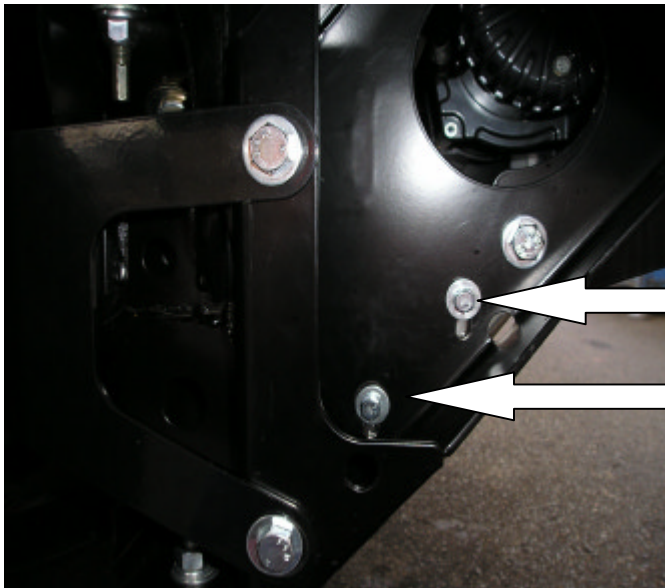

39 . Fit splash pan to bull bar sides using M6 x 20mm bolts, 6mm spring washers and 6mm large flat washers. Finger tighten only.

40. When all bolts are fitted tighten securely

ARROWS INDICATE M6 BOLT POSITION

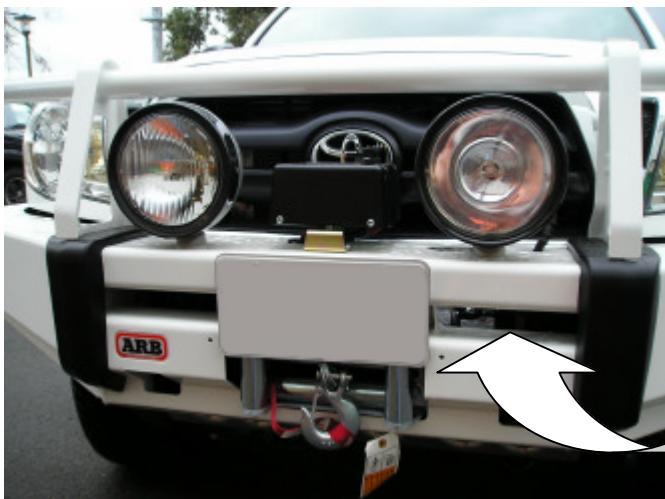

41. Fit number plate to number plate bracket using M6 hardware.

42. Driving lights can be fitted at this stage and can be tighten using a ratchet and socket which fits through the gap as per arrow

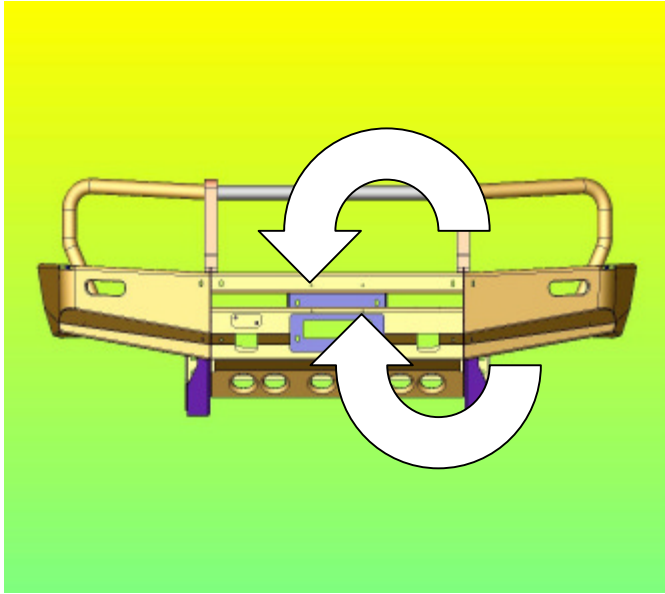

- 43. There is two positions for the number plate to be fitted to the bull bar.
- 44. Top arrow is position to bolt number plate for a winch bar.
- 45. Lower arrow is position to bolt number plate for a non winch bar.

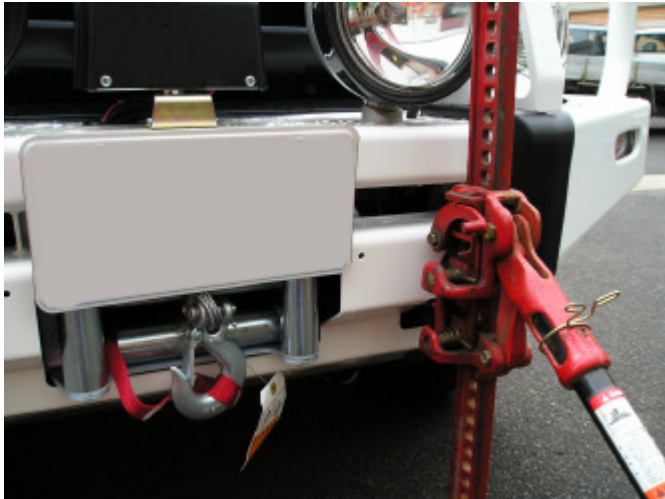

- 46. There is a provision on both sides of bar for a HiLift to be used.

FUNCTION	INDICATOR HARNESS	VEHICLE COMBINATION LAMP	
		RIGHT	LEFT
INDICATOR	GREEN	GREEN / YELLOW	GREEN / BLACK
EARTH	BLACK	WHITE/BLACK	WHITE/BLACK
PARK LAMP	RED	GREEN	GREEN

- 47. Finally fit indicator/parker light loom extension to light and wire to vehicle main light loom using scotch locks as per table.

