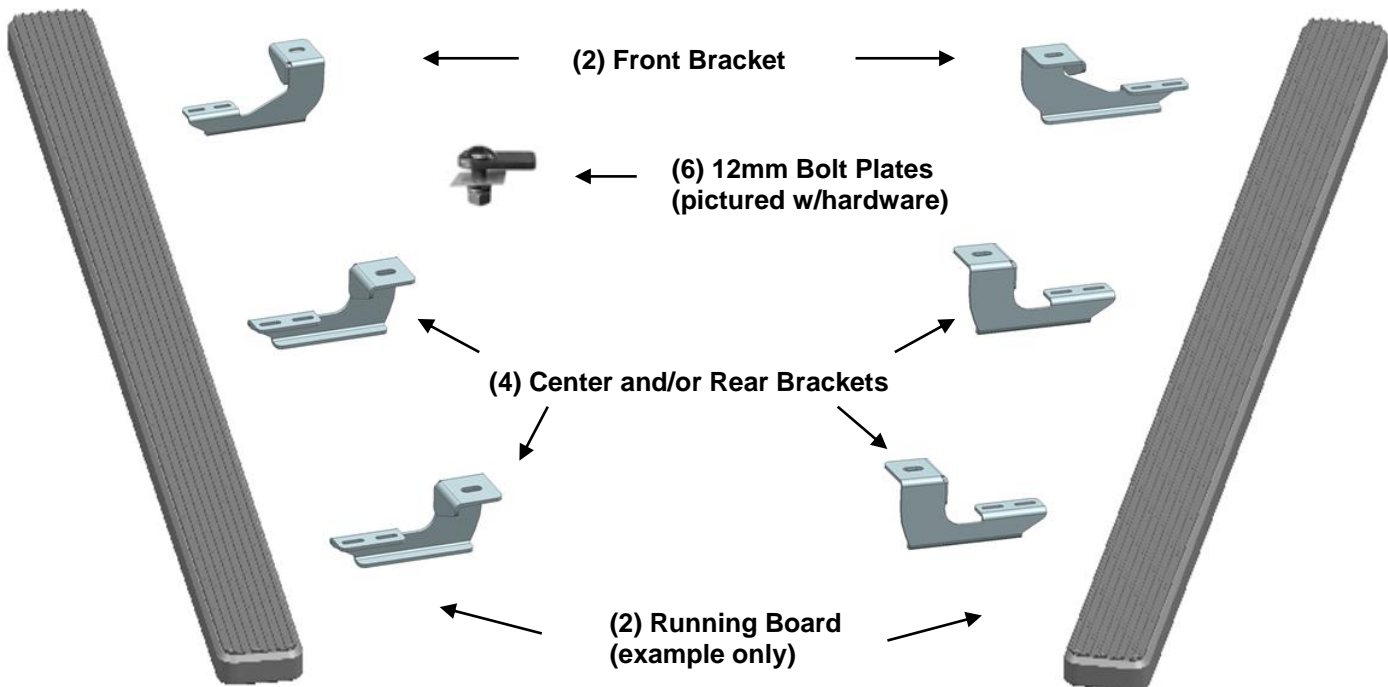


**PARTS LIST:**

Item	QTY	Description	Item	QTY	Description
#01	2	Running Board(use for left or right)	#07	6	12mm x 32mm OD x 3mm Flat Washers
#02	2	Front Mounting Bracket	#08	6	12mm Hex Nuts
#03	4	Center and/or Rear Brackets	#09	12	6-1.0mm x 20mm "T" Bolts
#04	6	12-1.75mm x 40mm Button Head Bolt Plates	#10	12	6mm Lock Washers
#05	6	12mm Plastic Retainers	#11	12	6mm x 22mm OD x 2mm Flat Washers
#06	6	12mm Lock Washers	#12	12	6mm Hex Nuts

**Front** ↑



**PROCEDURE:**

- 1. REMOVE CONTENTS FROM BOX. VERIFY ALL PARTS ARE PRESENT. READ FACTORY BODY BOLT REMOVAL INSTRUCTIONS AND INSTALLATION INSTRUCTIONS CAREFULLY BEFORE STARTING INSTALLATION.**
- Start installation by removing the factory hex nuts securing the bottom of the plastic rocker cover to the bottom of the vehicle, **(Figures 2, 3, 8 & 9)**. **VERY IMPORTANT:** Installation can be done without removing the plastic rocker cover but it may be easier to cut with the cover removed.
- Move to the passenger side front mounting location directly behind the front tire, **(Figure 1)**. Loosen the screw in the center of the plastic plug in the floor panel and remove the plug, **(Figures 2 & 3)**. **IMPORTANT:** The plastic plug is made up of (2) pieces. You must remove both the outer plug and the inner clip, **(Figure 3)**.
- Select (1) 12mm Bolt Plate and (1) 12mm Plastic Retainer, **(Figure 4A)**. Thread the Retainer part way onto the Bolt Plate. Insert the Bolt Plate into the hole in the floor panel, **(Figure 4B)**. Thread the Retainer down until it is tight against the floor panel. **IMPORTANT:** The Plastic

Retainer is designed to prevent the Bolt Plate from pushing up into the body panel and to aid in installing the Bracket.

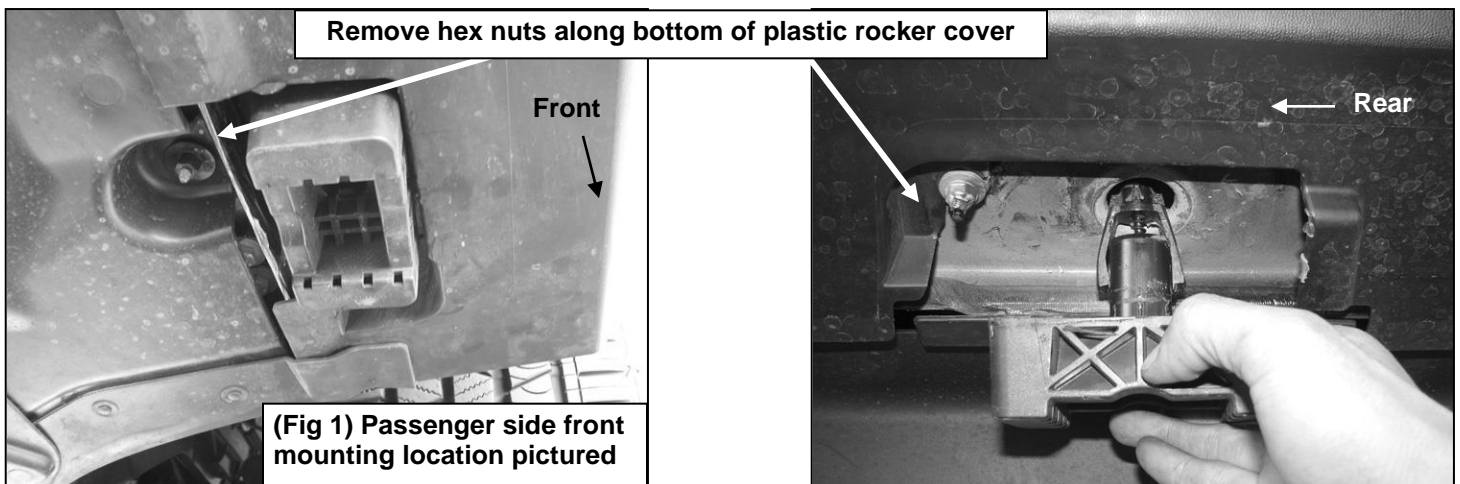
5. Next, select the Front Bracket. Slide the Bracket over the Bolt Plate and secure in place with (1) 12mm Flat Washer, (1) 12mm Lock Washer and (1) 12mm Hex Nut, **(Figure 5)**. Do not tighten.
6. With the rocker cover loose, pull the cover away from the bottom of the body to locate the factory hole in the floor panel. **IMPORTANT:** Correct factory hole is approximately 47" back from the front wheel opening, **(Figure 6)**. Remove the plug from the hole, **(Figure 7)**, and insert (1) Bolt Plate with (1) Plastic Retainer as previously described in **Step 4, (Figure 8)**. Mark the location of the Bolt Plate, (or factory hole for Bolt Plate), onto the cover, **(see white X-Figure 9A)**. Select (1) of the (2) Center/Rear Brackets. Hold the Bracket in place with the slot in the Bracket lined up over the mark for the Bolt Plate. Mark the outline of the Bracket onto the plastic cover, **(Figure 9B)**. Cut the cover only as necessary to clear the Bracket. **NOTE:** It may be necessary to trim the cover to allow for in and out movement during Bracket adjustment.
7. Attach the Bracket to the Bolt Plate with (1) 12mm Flat Washer, (1) 12mm Lock Washer and (1) 12mm Hex Nut, **(Figure 10)**. Do not tighten hardware at this time.
8. Move to the passenger side rear of the vehicle and remove the plastic plug directly in front of the rear tire as described in **Step 3, (Figure 11)**. Select the remaining Center/Rear Bracket. Repeat **Steps 3 – 4** for Rear Bracket installation, **(Figures 12 & 13)**.
9. Select a Running Board. Slip (6)6mm T-bolts into each bottom channel **(Figure 14)**. Carefully position the Running Board onto the (3) Mounting Brackets. **IMPORTANT:** Do not slide, (front to back), the Running Board on the Brackets or damage to the finish may result. Attach the Running Board to each Mounting Brackets with (2) 6mm T-bolts, (2)6mm flat washers, (2)6mm Hex Nuts and (2)6mm Lock Washers **(Figures 15)**. Do not tighten at this time.
10. Level and adjust Running Board properly and tighten all hardware.
11. Repeat **Steps 2—10** for passenger/right Running Board installation.
12. Do periodic inspections to the installation to make sure that all hardware is secure and tight

**To protect your investment**, wax this product after installing. Regular waxing is recommended to add a protective layer over the finish. Do not use any type of polish or wax that may contain abrasives that could damage the finish.

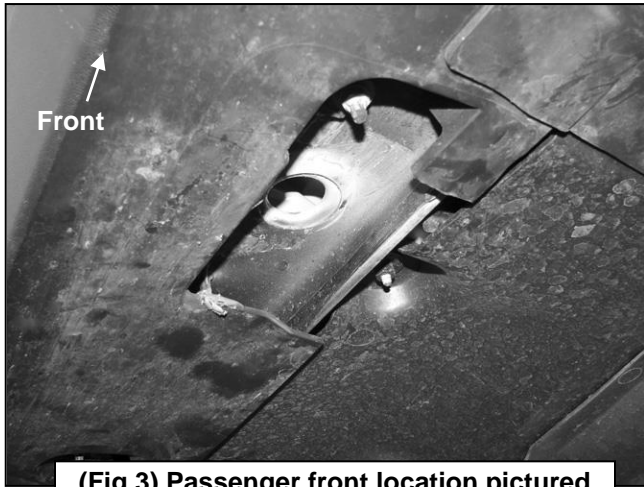
**For Polished Finishes:** Aluminum polish may be used to polish small scratches and scuffs on the finish. Mild soap may be used also to clean the Running Board.

**For Black Finishes:** Mild soap may be used to clean the Running Board.

### Passenger Side Installation Pictured

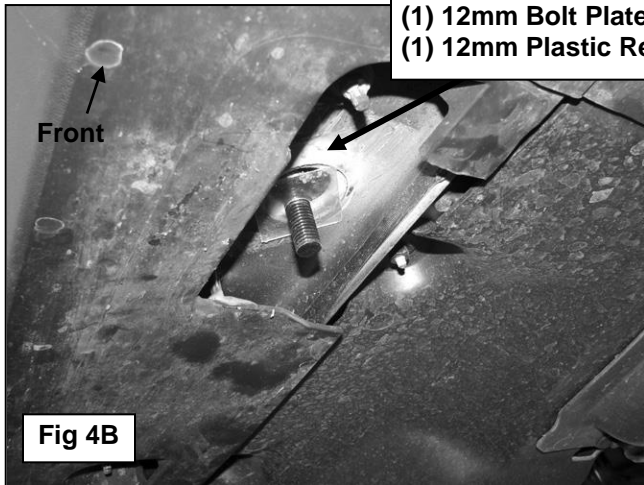
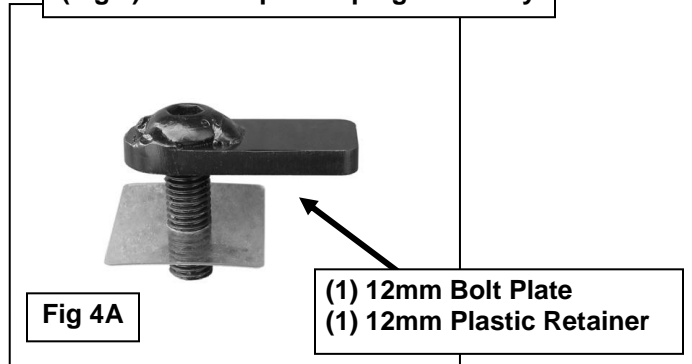


**Passenger Side Installation Pictured**

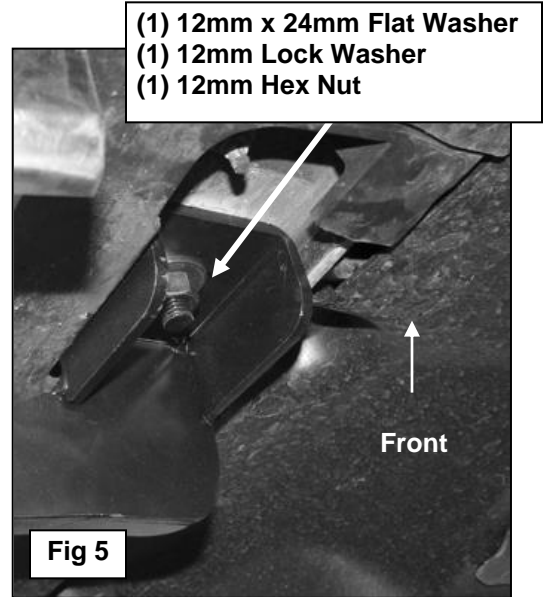


**(Fig 3) Passenger front location pictured**

**(Fig 2) Remove plastic plug assembly**

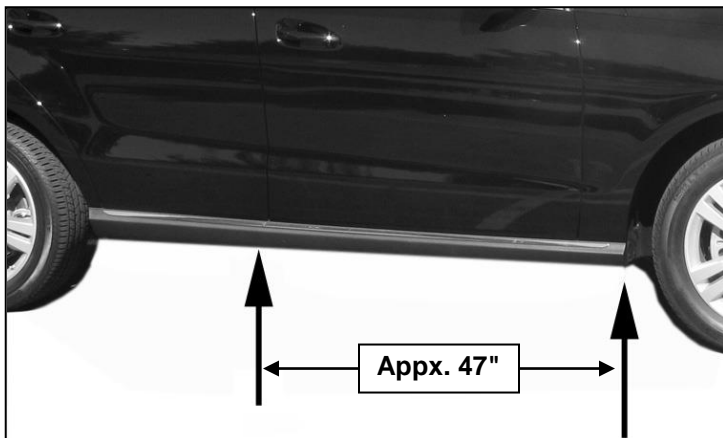


**Fig 4B**

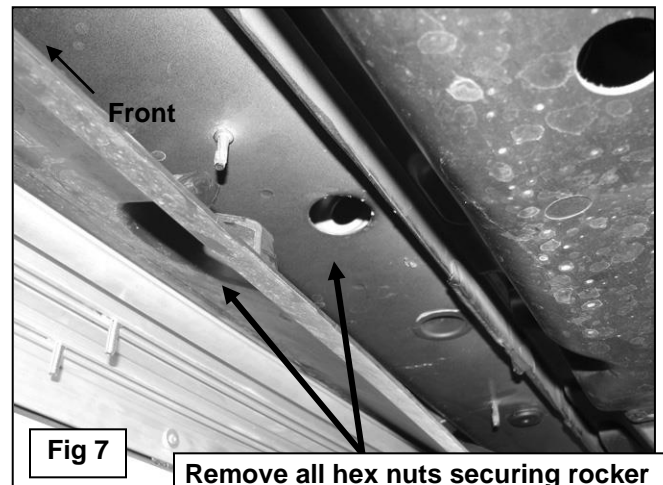


**Fig 5**

**Running Board pictured in place for instruction purposes only and will not be installed until the final steps**



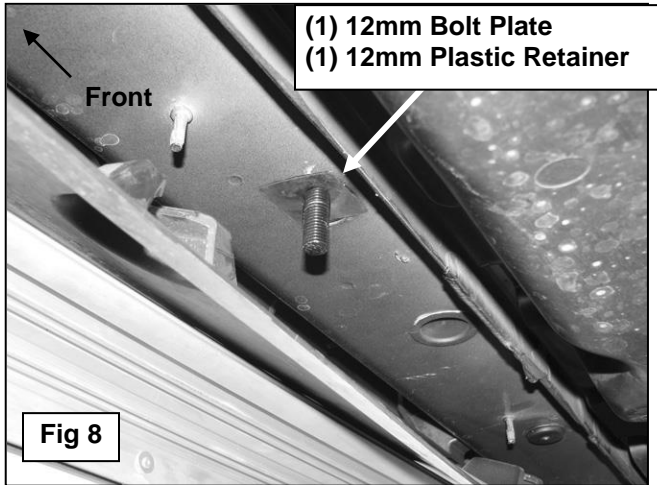
**(Fig 6) Hole used for center Bracket is approximately 47" back from corner of front wheel opening**



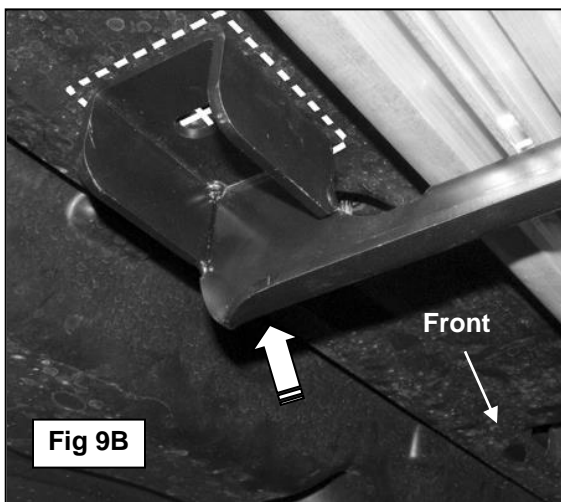
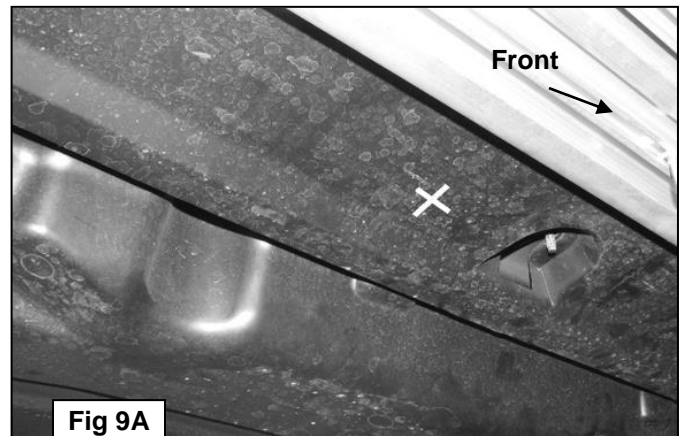
**Fig 7**

**Remove all hex nuts securing rocker cover to floor panel. Pull back cover to locate hole for center Bracket**

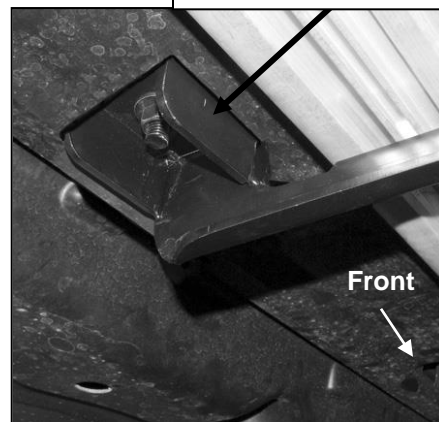
### Passenger Side Installation Pictured



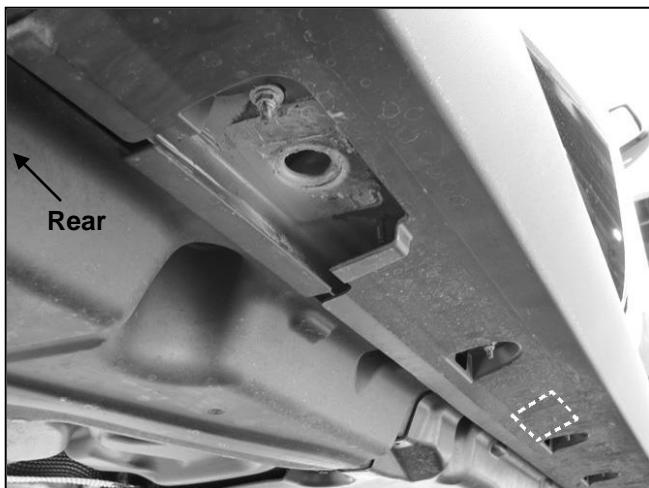
Mark the center of the hole and/or the Bolt Plate onto the cover, (white X in Fig. 8A & B). Cut a small hole in center to locate Bolt Plate. Hold Bracket in place with center of slot over small hole. Trace outside of Bracket onto bottom of plastic rocker panel cover. Carefully cut out opening with sharp knife or hacksaw blade.



- (1) 12mm x 24mm Flat Washer
- (1) 12mm Lock Washer
- (1) 12mm Hex Nut



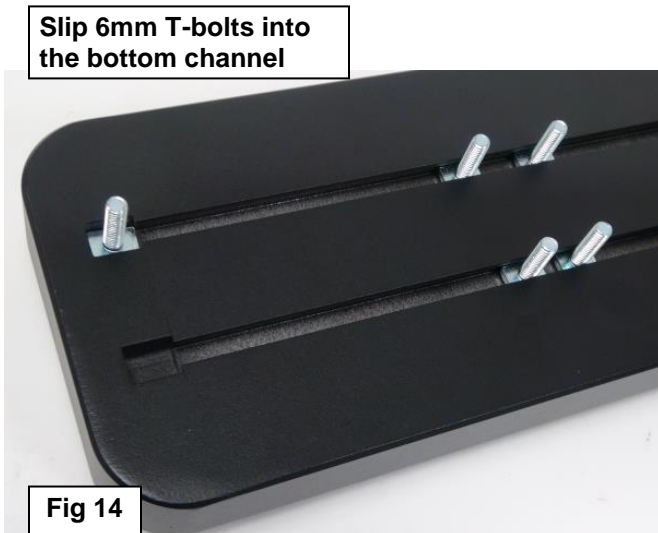
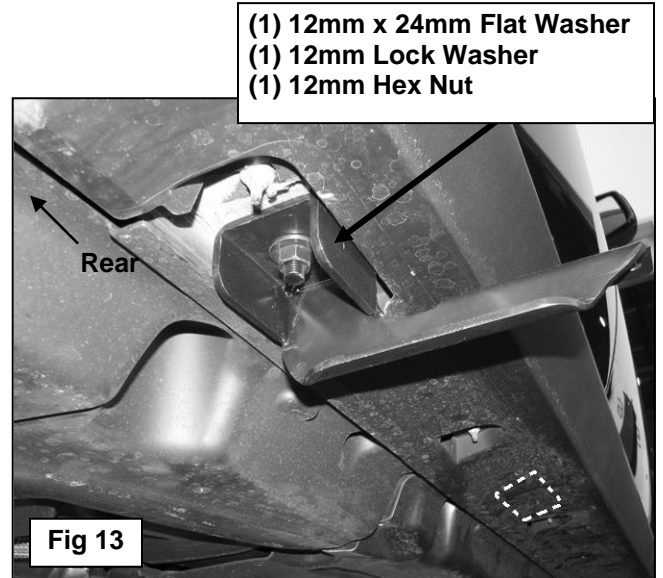
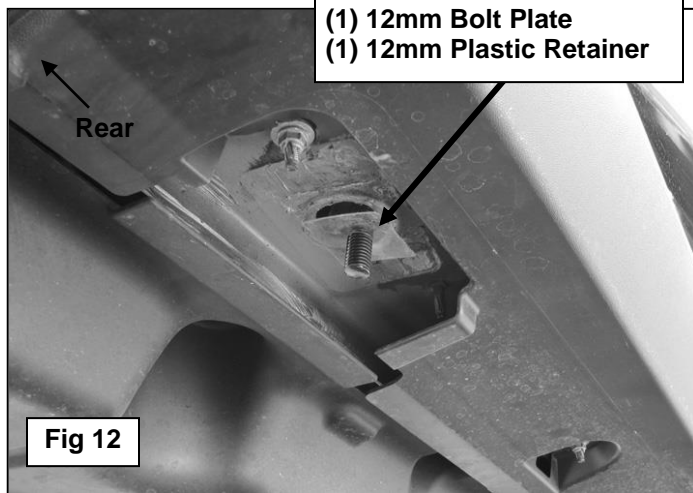
(Fig 10) Passenger side center Bracket installed



(Fig 11) Passenger side rear location pictured

Running Board pictured in place for instruction purposes only and will not be installed until the final steps

### Passenger Side Installation Pictured



- (2) 6mm T-bolts
- (2) 6mm Flat Washers
- (2) 6mm Hex Nuts
- (2) 6mm Lock Washers

