



iRunning Board Installation Instruction

Part#: IB20RIG3

Application: For 2010-2018 Toyota 4Runner Trail Edition /2014-2018 4Runner SR5
(Excl.14-18 SR5 & 10-18 Trail Edition)(Only fit all Models with Lower Rocker
Panel Extensions)

PARTS LIST:

Item	QTY	Description	Item	QTY	Description
#01	1	Driver side running board	#07	12	M8x30mm Hex Bolts
#02	1	Passenger side running board	#08	12	M8 Lock Washers
#03	1	Driver Front Mounting Bracket (DFM)	#09	12	M8 Flat Washers
#04	1	Passenger Front Mounting Bracket (PFM)	#10	12	M6 Nylon Lock Nuts
#05	2	Driver Center & Rear Mounting Bracket (DCM/DRM)	#11	12	M6 T- Bolts
#06	2	Passenger Center & Rear Mounting Bracket (PCM/PRM)	#12	12	M6 Flat Washers

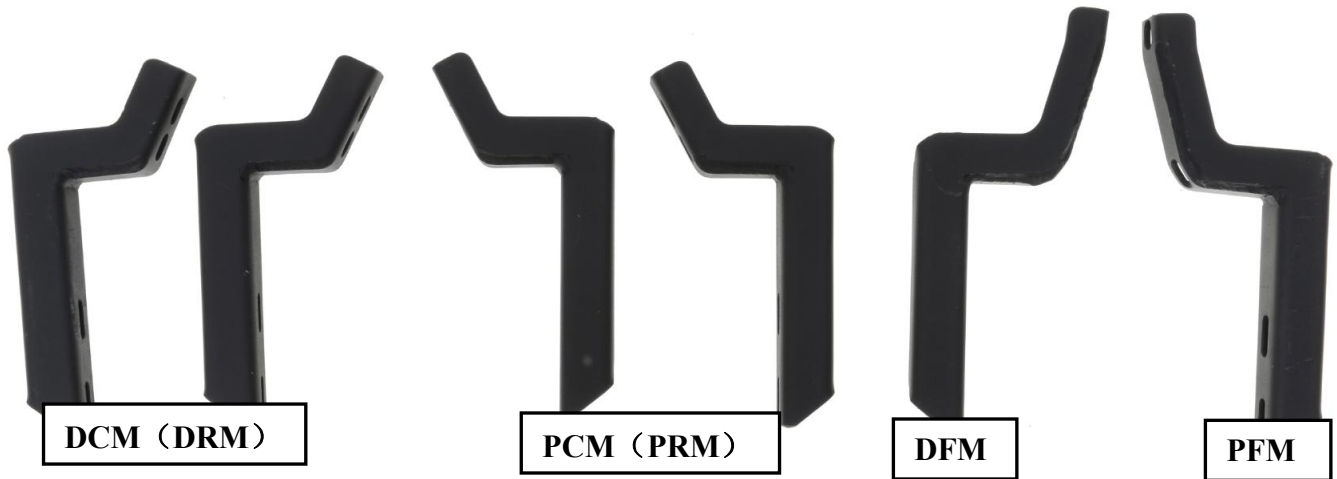

INSTALLATION INSTRUCTION:

1. REMOVE CONTENTS FROM BOX. VERIFY ALL PARTS ARE PRESENT. READ INSTRUCTIONS CAREFULLY BEFORE STARTING INSTALLATION. PLEASE NOTE: 200LBS IS THE MAXIMUM RATED LOAD FOR THE VIEWPOINT RUNNING BOARDS.
2. Start installation on the passenger side of the vehicle, remove the existing (2) factory bolts located by the front tire opening securing the factory rocker panel bracket to the vehicle, (Figure 1). Select (1) Front Mounting Bracket. Hold the Front Bracket over the rocker panel bracket and line up the (2) mounting holes. Secure the brackets to the vehicle using the included longer (2) 8mmx30mm Hex Bolts, (2) 8mm Lock Washers and (2) 8mm Flat Washers, (Figure 2). Do not tighten hardware at this time.
3. The center and rear brackets are identical. Select (1) Center & Rear Bracket and repeat the procedure as described in **Step 2** to install it in the center mounting location, (Figure 3&4). **NOTE:** Install (1) mounting bracket at a time. Do not tighten hardware at this time.
4. Carefully unwrap the Running Board and select passenger side Board. Select (6) T-Bolts. Insert (3) T-Bolts into each channel on the bottom of the Running Board, (Figure 5). Slide the T-Bolts forward or back to line up with the (3) previously installed Mounting Bracket, (Figure 6). Hold the Running Board up to the vehicle at a slight angle and gently push it into position against the end of the Brackets. **IMPORTANT:** Depending on year/model, it may be necessary to remove the plastic deflector from in front of the rear tire opening, (Figure 3)
5. Attach the Running Board to the Mounting Brackets with the included (6) 6mm Flat Washers, (6) 6mm Lock Washers and (6) M6 T- Bolts, (Figure 7 & 9). Do not tighten at this time.
6. Repeat **Steps 2 - 5** for the driver side Running Board installation.
7. Do periodic inspections to the installation to make sure that all hardware is secure and tight.

iRunning Board Installation Instruction

Part#: IB20RIG3

Application: For 2010-2018 Toyota 4Runner Trail Edition /2014-2018 4Runner SR5
(Excl.14-18 SR5 & 10-18 Trail Edition)(Only fit all Models with Lower Rocker
Panel Extensions)

To protect your investment, wax this product after installing. Regular waxing is recommended to add a protective layer over the finish. Do not use any type of polish or wax that may contain abrasives that could damage the finish.

For Polished Finishes: Aluminum polish may be used to polish small scratches and scuffs on the finish. Mild soap may be used also to clean the Running Board.

For black finishes: Mild soap may be used to clean the Running Board.

Passenger Side Installation Pictured

Remove factory hex bolts

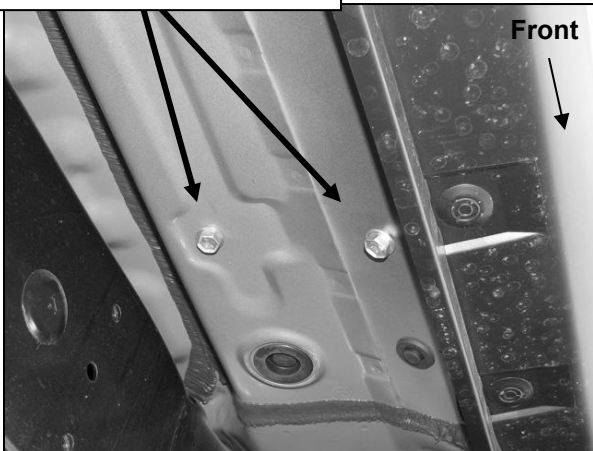

(Fig 1) Passenger side front mount pictured

(2) 8mm x 30mm Hex Bolts
(2) 8mm Flat Washers
(2) 8mm Lock Washers

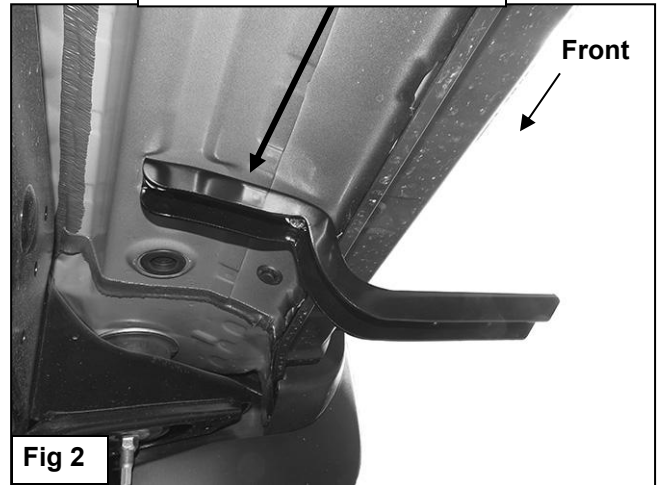

Fig 2

Plastic deflector



(Fig 3) Passenger side rear bracket location pictured

Remove factory hex bolts

(2) 8mm x 30mm Hex Bolts
(2) 8mm Flat Washers
(2) 8mm Lock Washers

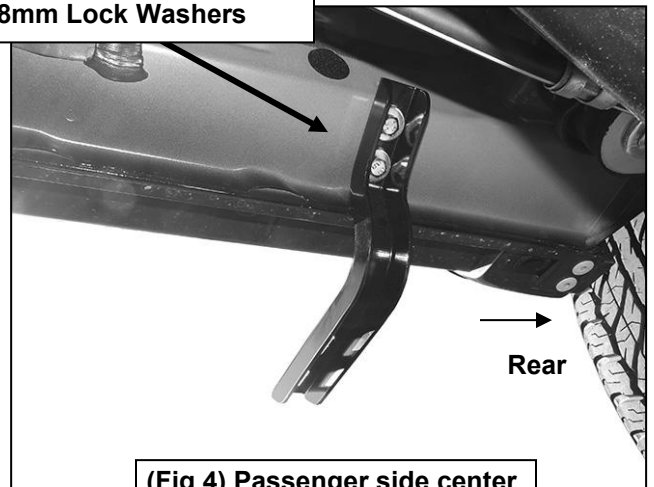

(Fig 4) Passenger side center and rear brackets pictured

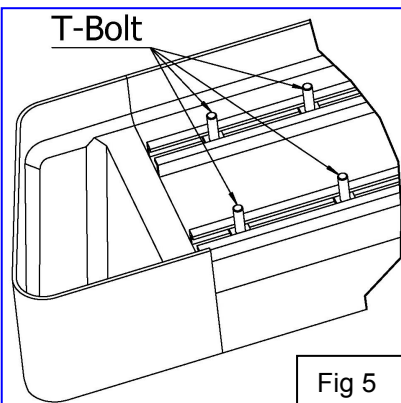

iRunning Board Installation Instruction

Part#: IB20RIG3

Application: For 2010-2018 Toyota 4Runner Trail Edition /2014-2018 4Runner SR5
(Excl.14-18 SR5 & 10-18 Trail Edition)(Only fit all Models with Lower Rocker
Panel Extensions)

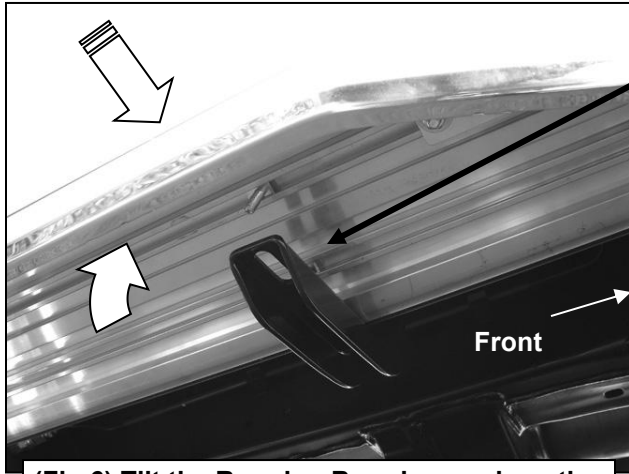

(Fig 6) Tilt the Running Board up and gently push back into position against rocker panel. Line up T-Bolts with Brackets

Slide T-Bolt along slots to line up with Mounting Brackets

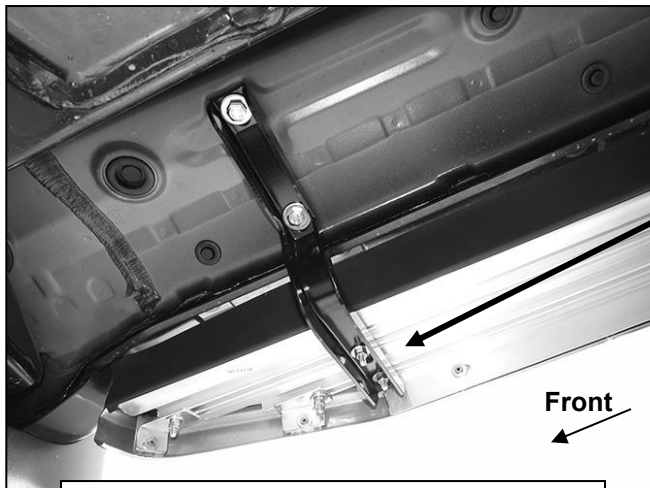
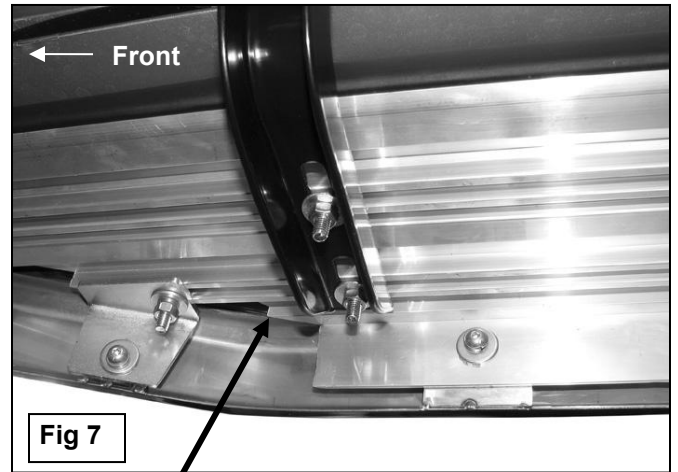

(Fig 8) Front Bracket installation pictured

- (2) 6mm Flat Washers
- (2) 6mm Lock Washers
- (2) 6mm Hex Nuts

**Pictures are for reference only, actual bars may be a little different.*

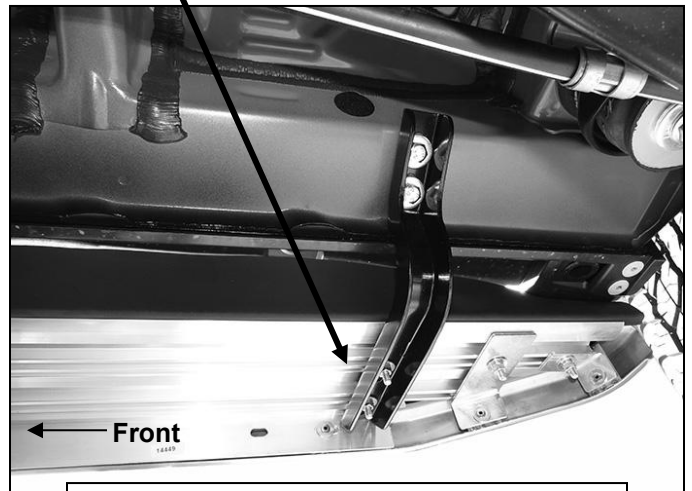

INSTALLATION IS COMPLETE!