

Installation Instructions for IB20EJI9

by APS Auto Parts Specialist Inc.

Application: For 2001-2007 Toyota Highlander/2004-2009 Lexus RX330/
2006-2009 RX400H

Estimated Time: 1 to 2 hours



Disclaimer: Instructions intended for persons aged 18+ please do not attempt without adult supervision. Instructions are not intended to replace professional installation. Damage from improper installation, misuse or modification to the product voids the manufacturer's warranty.

PARTS LIST:

Item	QTY	Description	Item	QTY	Description
#01	2	Step Board (use for left or right)	#12	2	M10X40mm Bolt Plate (Long)
#02	4	Driver&Passenger Bar Mounting Bracket (DFB)	#13	8	M12X40mm Hex Bolts
#03	1	Driver Front Mounting Bracket (DFM)	#14	10	M12 Hex Nuts
#04	1	Driver Front Support Bracket (Long) (DFS)	#15	18	M12 Flat Washers
#05	1	Driver Rear Mounting Bracket (DRM)	#16	10	M12 Lock Washers
#06	1	Passenger Front Mounting Bracket (PFM)	#17	4	M10 Hex Nuts
#07	1	Passenger Front Support Bracket(Short) (PFS)	#18	4	M10 Flat Washers
#08	1	Passenger Rear Mounting Bracket (PRM)	#19	4	M10 Lock Washers
#09	2	Plastic Retainers	#20	16	M6 Square Head Bolts
#10	2	M12X50 Bolt Plate	#21	16	M6 Flat Washers
#11	2	M10X40mm Bolt Plate (Short)	#22	16	M6 Nylon Lock Nuts

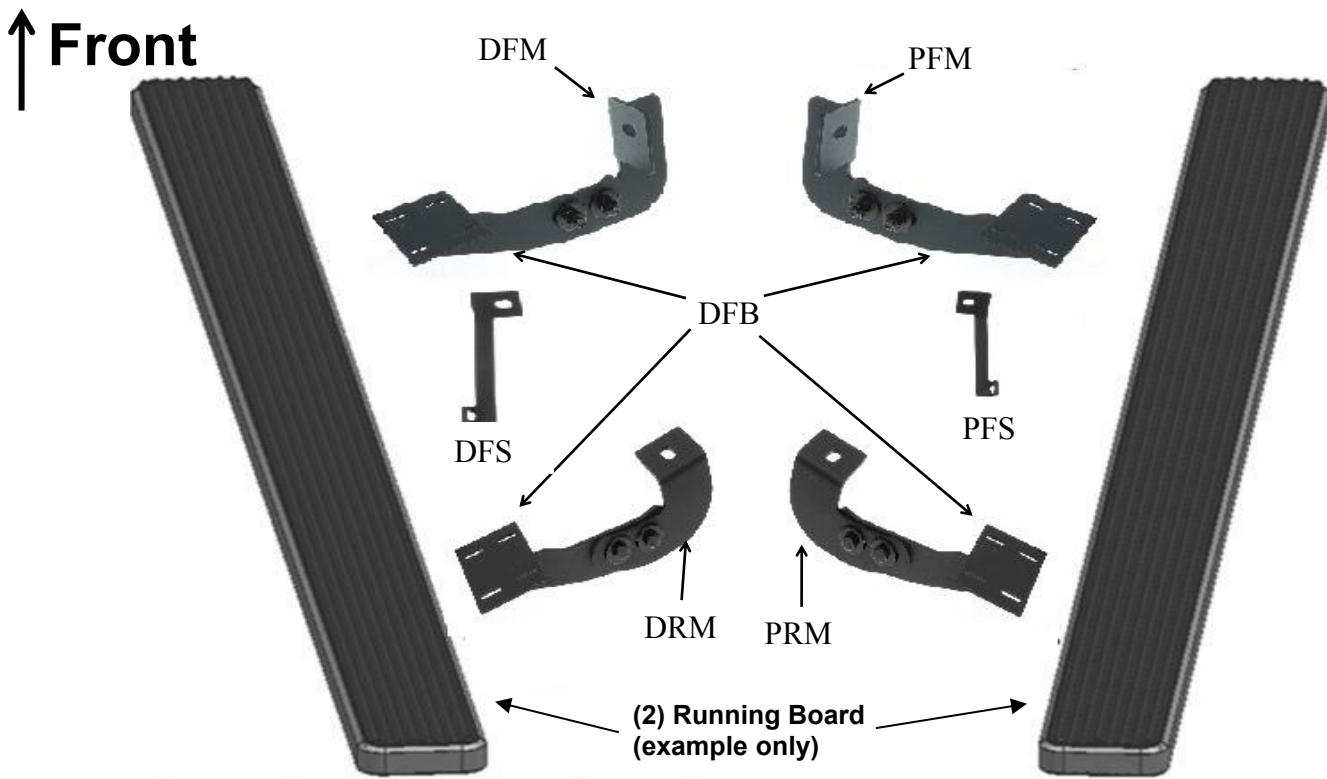

INSTALLATION INSTRUCTION:

REMOVE CONTENTS FROM BOX. VERIFY ALL PARTS ARE PRESENT. READ INSTRUCTIONS CAREFULLY BEFORE STARTING INSTALLATION.

1. Before starting installation, locate (1) 10mm Plastic Retainer and (1) 10mm x 40mm Long Bolt Plate. Thread the Plastic Retainer part way onto the Bolt Plate, **(Figure 1A)**.
2. From underneath the front of the driver side of the vehicle, insert (1) 10mm x 40mm Long Bolt Plate with Retainer into the factory hole on the side body panel, **(Figure 1B)**. **IMPORTANT!** The Plastic Retainer is designed to prevent the Bolt Plate from falling into the body cavity and to aid in mounting the Bracket.
3. Carefully place the driver side front Mounting Bracket over the already inserted 10mm Long Bolt Plate and secure it using the included (1) 10mm Flat Washer, (1) 10mm Lock Washer and (1) 10mm Hex Nut, **(Figure 2)**. Do not tighten at this time.

4. Locate the upper hole in the floor panel and insert (1) 10mm x 40mm Short Bolt Plate, **(Figure 3)**.
5. Partially hang the driver side Front Support Bracket (Longer Bracket) from the 10mm Short Bolt Plate with (1) 10mm Flat Washer, (1) 10mm Lock Washer and (1) 10mm Hex Nut, **(Figure 4)**.
6. Moving to the rear of the vehicle, insert (1) 12mm x 50mm Bolt Plate into factory oval hole in the floor panel, **(Figure 5)**. Rotate the Bolt Plate 90-degrees or until it stops spinning to properly support both sides of the flat surface on the Bolt Plate.
7. Partially hang the driver side Rear Mounting Bracket from the previously inserted 12mm Bolt Plate using the included (1) 12mm Flat Washer, (1) 12mm Lock Washer and (1) 12mm Hex Nut, **(Figure 6)**. Do not tighten at this time.
8. Select a Running Board. Slip(4)6mm Square Head Bolts into each bottom channel(**Figure 7**). Carefully position the Running Board onto the (2) Mounting Brackets. **IMPORTANT:** Do not slide, (front to back), the Running Board on the Brackets or damage to the finish may result. Attach the Running Board to each Mounting Brackets with(4) M6 Square Head Bolts,(4)M6 flat washers and (4)M6 nylon lock nuts **(Figures 8)**. Do not tighten at this time.
9. Level and adjust Running Board properly and tighten all hardware.
10. Repeat steps 1 -9 for Passenger Sidebar Installation.
11. Do periodic inspections to the installation to make sure all hardware is secure and tight.

To protect your investment, wax this product after installing. Regular waxing is recommended to add a protective layer over the finish. Do not use any type of polish or wax that may contain abrasives that could damage the finish.

For Polished Finishes: Aluminum polish may be used to polish small scratches and scuffs on the finish. Mild soap may be used also to clean the Running Board.

For black finishes: Mild soap may be used to clean the Running Board.

DRIVER SIDE INSTALLATION PICTURED

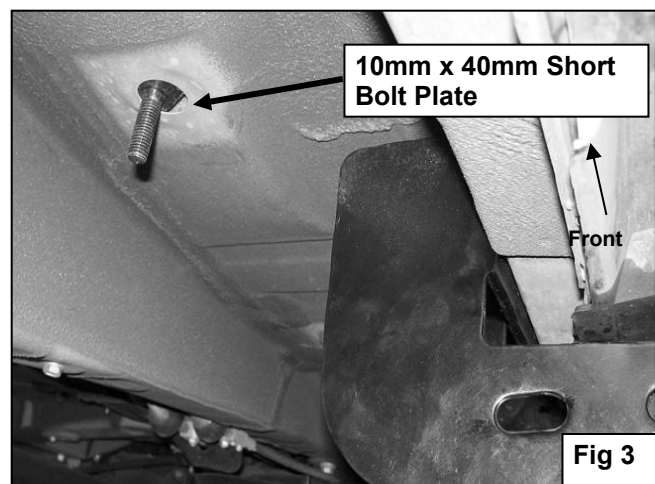
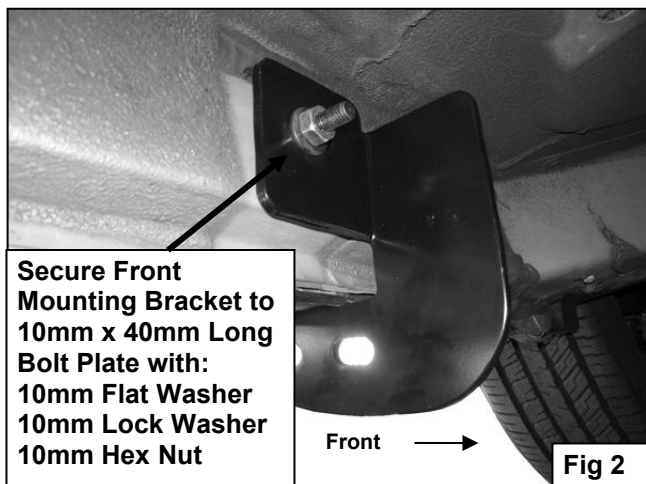
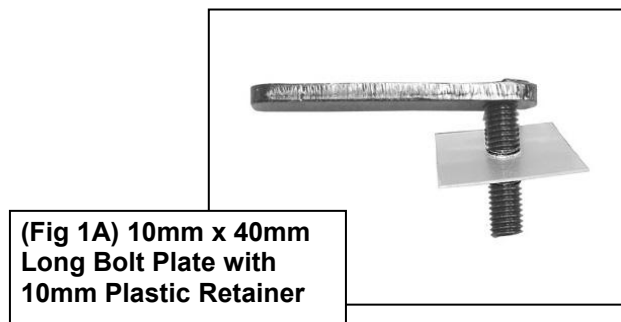
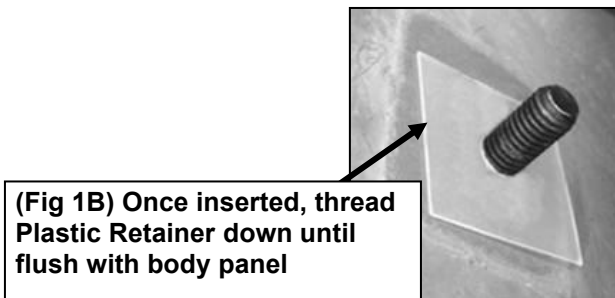

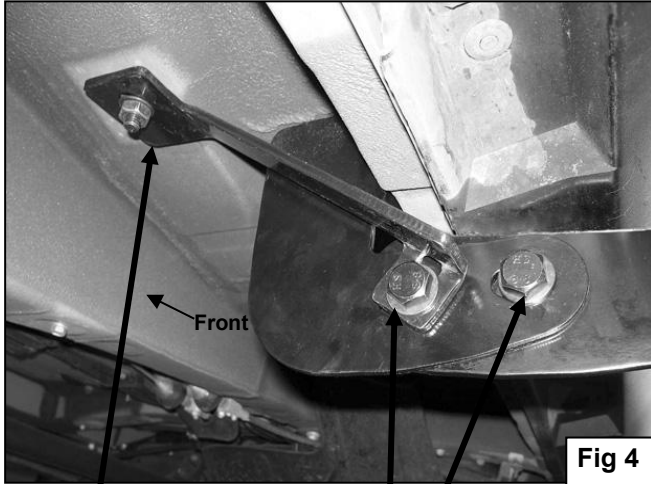

Secure Support Bracket to 10mm x 40mm Short Bolt Plate with:
 10mm Flat Washer
 10mm Lock Washer
 10mm Hex Nut

12mm x 40mm Hex Bolt
 (2) 12mm Flat Washers
 12mm Lock Washer
 12mm Hex Nut

12mm x 50mm Bolt Plate secured with:
 12mm Flat Washers
 12mm Lock Washer
 12mm Hex Nut

(2)12mm x 40mm Hex Bolt
 (4) 12mm Flat Washers
 (2)12mm Lock Washer
 (2)12mm Hex Nut

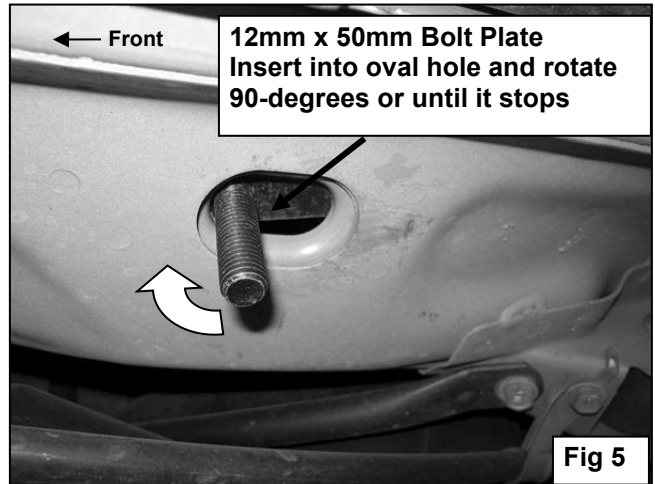

← Front
 12mm x 50mm Bolt Plate
 Insert into oval hole and rotate 90-degrees or until it stops

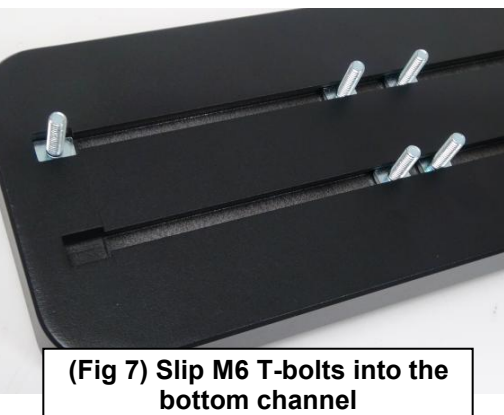
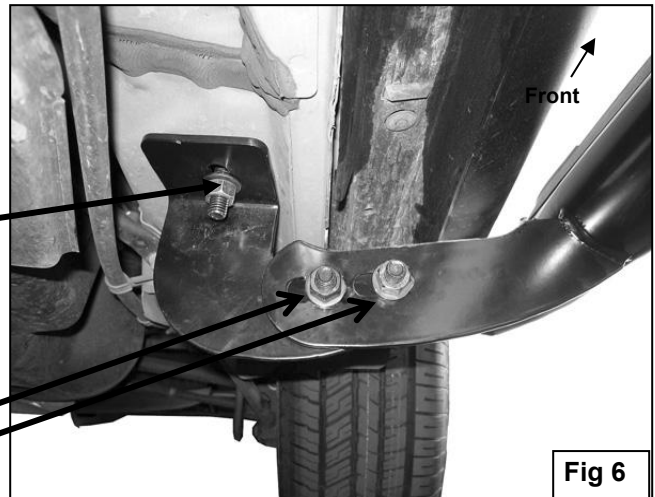

(Fig 7) Slip M6 T-bolts into the bottom channel

(4)M6 Square Head Bolts
 (4)M6 Flat Washers
 (4)M6 Nylon Lock nuts

