

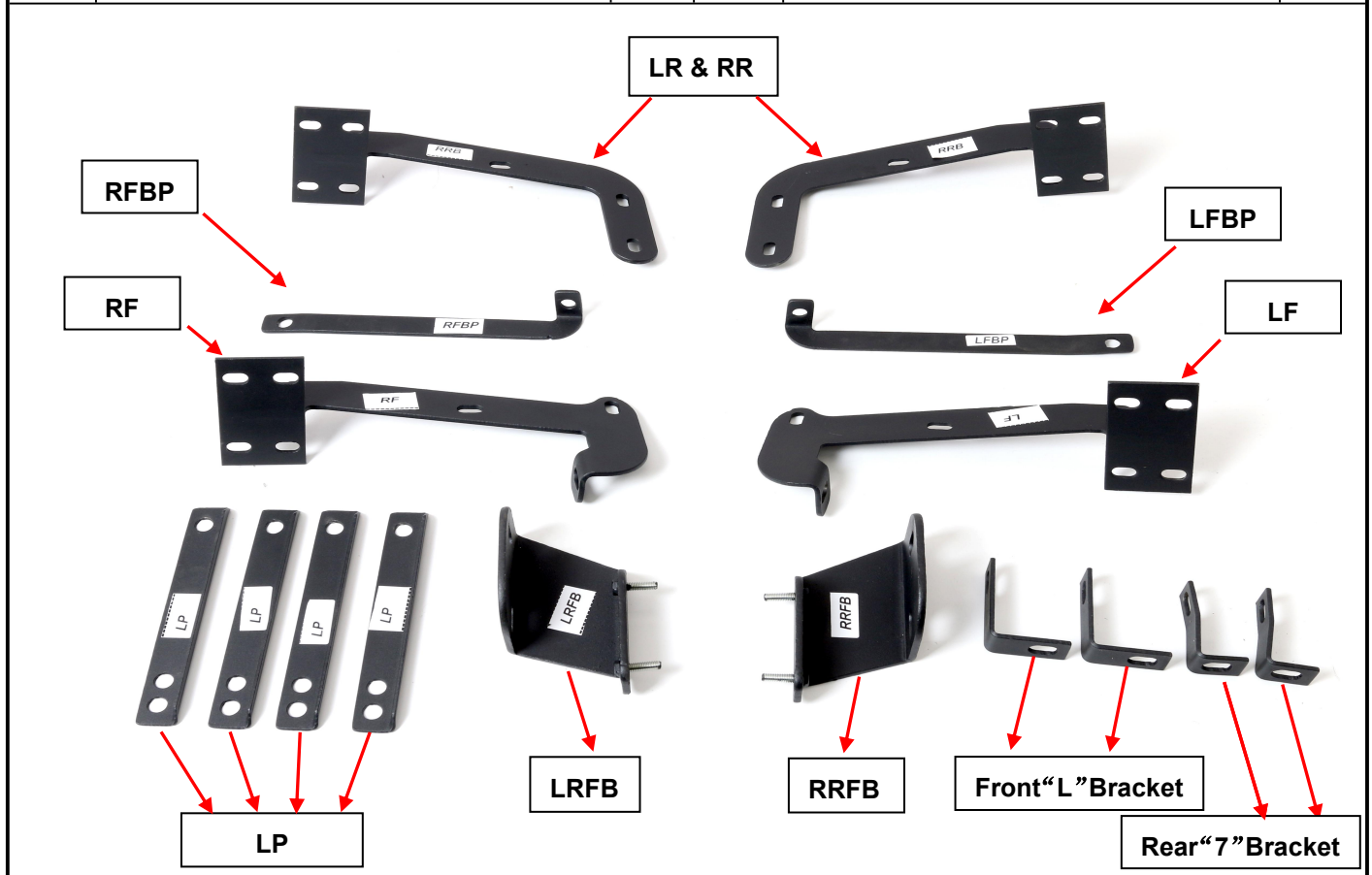


## Installation Instruction

**Part#: IB14DAH0B**

**Application: For 2013 NISSAN PATHFINDER**

Item	Description	QTY	Item	Description	QTY
1	Driver/Left Sidebar	1	13	M10 Bolt Plate	12
2	Passenger/Right Sidebar	1	14	Double M10 Bolt Plate	2
3	Driver Front Mounting Bracket (LF)	1	15	M10 Plastic Retainer	12
4	Passenger Front Mounting Bracket (RF)	1	16	M10 Flat Washer	12
5	Driver Front Inner Support Bracket (LFBP)	1	17	M10 Lock Washer	16
6	Passenger Front Inner Support Bracket (RFBP)	1	18	M10 Hex Nut	16
7	Front "L" Support Bracket	2	19	M8x30mm Hex Bolt	6
8	Driver Rear Frame Bracket (LRFB)	1	20	M8x25mm Hex Bolt	16
9	Passenger Rear Frame Bracket (RRFB)	1	21	M8 Flat Washer	16
10	Driver/Passenger Rear Bracket (LR & RR)	2	22	M8 Lock Washer	26
11	Rear "7" Support Bracket	2	23	M8 Hex Nut	10
12	Lock Plate (LP)	4	24	M8 STD Flat Washer	16



The instruction here is for your reference only. We strongly recommend the professional installer for best result. We are not responsible for any damage caused by the installation. Thank you for choosing our product!

## Installation Instruction

**Part#: IB14DAH0B**

**Application: For 2013 NISSAN PATHFINDER**

Step	Installation Instruction
<b>REMOVE CONTENTS FROM BOX. VERIFY ALL PARTS ARE PRESENT. READ INSTRUCTIONS CAREFULLY BEFORE STARTING INSTALLATION.</b>	
1	Start installation on the driver side of the vehicle. Locate and remove the (2) rubber plugs in the bottom of the outer frame channel closest to the front wheel opening, <b>(Figure 1)</b> .
2	Select (2) M10 Bolt Plates and (2) M10 Plastic Retainers, <b>(Figure 2A)</b> . Partially thread the Retainers onto the Bolt Plates. <b>Note:</b> The Plastic Retainer is designed to help hold the Bolt Plate in Place during Bracket installation.
3	Insert (1) Bolt Plate into the first-forward hole with the plate pointed toward the rear of the vehicle, <b>(Figure 2B)</b> . Thread the Plastic Retainer down tight against the body panel. Repeat to install the next Bolt Plate into the second hole with the Plate pointed toward the front of the vehicle, <b>(Figure 3)</b> . <b>IMPORTANT:</b> The Plates on the (2) Bolt Plates must be pointed toward each other.
4	Select (1) Lock Plate, <b>(Figure 3)</b> . Slide the Lock Plate over the (2) Bolt Plates with the bent side toward the pinch weld. Attach the Lock Plate to the <u>rear</u> Bolt Plate only with (1) M10 Flat Washer, (1) M10 Lock Washer and (1) M10 Hex Nut, <b>(Figure 4)</b> . Tighten the Hex Nut at this time.
5	Locate the round hole in the back of the outer frame channel directly behind the previously installed Bolt Plates, <b>(Figure 5B)</b> . Remove the rubber plug. Select (1) M10 Bolt Plate and (1) M10 Plastic Retainer, <b>(Figure 5A)</b> . Partially thread the Retainer onto the Bolt Plate. Insert the Bolt Plate into the hole and tighten the Retainer as previously described. <b>IMPORTANT:</b> Mounting areas may be covered with undercoating. Scrape excess undercoating from body panel at all mounting locations. Brackets must mount flat against body panels
6	Select (1) Front "L" Support Bracket, <b>(Figure 6)</b> . Attach the shorter leg on the Support Bracket to the front Bolt Plate with (1) M10 Flat Washer,(1) M10 Lock Washer and (1) M10 Hex Nut, <b>(Figures 7 &amp; 8)</b> . Leave hardware loose at this time.
7	Select the driver side Front Mounting Bracket. Attach the Bracket to the Bolt Plate in the back of the frame channel first with (1) M10 Flat Washer,(1) M10 Lock Washer and (1) M10 Hex Nut, <b>(Figure 7)</b> . Attach the Mounting Bracket to the back of the "L" Support Bracket with (1) M8x30mm Hex Bolt, (2) M8 Large Flat Washers, (1) M8 Lock Washer and (1) M8 Hex Nut, <b>(Figures 7 &amp; 8)</b> . Do not tighten hardware at this time.
8	Next, locate the factory holes in the bottom of the inner frame channel directly behind the tie down loop where frame is joined together. Determine the correct factory hole to use. <b>Driver side installation :</b> Use the factory hole closest to the loop, <b>(Figure 9B)</b> <b>Passenger side installation:</b> Use the 2 <sup>nd</sup> factory hole <u>back</u> from the loop, <b>(Figure 10)</b>
9	Select (1) M10 Bolt Plate and (1) M10 Plastic Retainer, <b>(Figure 9A)</b> . Partially thread the Retainer onto the Bolt Plate . Insert the Bolt Plate into the correct factory hole in the frame channel as identified in Step 9, <b>(Figure 9B &amp; 10)</b> . <b>IMPORTANT:</b> The driver and passenger side Front Inner Support Brackets do not install in the same manner.

The instruction here is for your reference only. We strongly recommend the professional installer for best result. We are not responsible for any damage caused by the installation. Thank you for choosing our product!

## Installation Instruction

**Part#: IB14DAH0B**

**Application: For 2013 NISSAN PATHFINDER**

10	<p>Select the correct Inner Front Support Bracket, <b>(Figure 11)</b>. Attach the 90-degree bent end of the Support Bracket to the Bolt Plate in the frame channel with (1) M10 Flat Washer, (1) M10 Lock Washer and (1) M10 Hex Nut, <b>(Figure 12)</b>. Bolt the outer end of the Support Bracket to the front Mounting Bracket with (1) M8x30mm Hex Bolt, (2) M8 Large Flat Washers, (1) M8 Lock Washer and (1) M8 Hex Nut, <b>(Figure 12)</b>. Do not tighten hardware at this time.</p> <p><b>Attach the driver side</b> inner Support Bracket to the <b>front</b> of the Front Mounting Bracket, <b>(Figure 12)</b>.</p> <p><b>Attach the passenger side</b> inner Support Bracket to the <b>back</b> of the Front Mounting Bracket, <b>(Figure 10)</b></p>
11	<p>Move to the rear mounting location in front of the driver side rear tire opening. Locate the large oval and the round holes in the inner body panel in front of the rear tire. <b>(Figure 13)</b>. Select (1) M10 Double Bolt Plate and (1) M10 Plastic Retainer, <b>(Figure 14A)</b>. Insert the Bolt Plate into the oval hole and up and out of the smaller round hole above it. Thread the Plastic Retainer onto the Bolt Plate in the round hole only, <b>(Figure 14B)</b></p>
12	<p>Locate the last (2) round holes along the floor panel, <b>(Figure 14B)</b>. Repeat Steps 2-5 to install the (2) Bolt Plates and Lock Plate, <b>(Figures 15 &amp; 16)</b>. NOTE: Attach the Lock Plate to the <u>front Bolt Plate</u> only with (1) M10 Flat Washer, (1) M10 Lock Washer and (1) M10 Hex Nut, <b>(Figure 16)</b>. Tighten the Hex Nut at this time.</p>
13	<p>Select the driver side rear Frame Bracket. Attach the Frame Bracket to the Double Bolt with (2) M10 Flat Washers, (2) M10 Lock Washers and (2) M10 Hex Nuts, <b>(Figures 17 &amp; 18)</b>. Do not tighten hardware at this time. Next, attach the driver side Rear Mounting Bracket to the front of the Frame Bracket with (2) M8 Large Flat Washers, (2) M8 Lock Washers and (2) M8 Hex Nuts, <b>(Figure 19)</b>. Do not tighten hardware at this time.</p>
14	<p>Select the driver side "7" Rear Support Bracket, <b>(Figure 6 &amp; 17)</b>. Attach the Support Bracket to the rear Bolt Plate with (1) M10 Flat Washer, (1) M10 Lock Washer and (1) M10 Hex Nut, <b>(Figures 17 &amp; 19)</b>. Do not tighten hardware. Line up the hole in the Rear Bracket with the "7" Rear Support Bracket. Bolt the Mounting Bracket to the front of the "7" Bracket with (1) M8x30mm Hex Bolt, (2) M8 Large Flat Washers, (1) M8 Lock washer and (1) M8 Hex Nut, <b>(Figure 19)</b>. Do not tighten hardware at this time.</p>
15	<p>Select the driver/left Sidebar. Carefully place the Sidebar in position on top of the Brackets. Line up the threaded holes in the Sidebar with the slots in the Brackets. Bolt the Sidebar to the Brackets with (4) M8x25mm Hex Bolts, (4) M8 Lock Washers and (4) M8 Large Flat Washers, <b>(Figure 20)</b>. Do not tighten hardware at this time.</p>
16	<p>Adjust and level the Sidebar and tighten all hardware.</p>
17	<p>Repeat <b>Steps 1-16</b> for passenger Sidebar installation.</p>
18	<p>Do periodic inspections to the installation to make sure that all hardware is secure and tight.</p>
<p><b>To protect your investment</b>, wax this product after installing. Regular waxing is recommended to add a protective layer over the finish. Do not use any type of polish or wax that may contain abrasives that could damage the finish.</p> <p><b>For stainless steel:</b> Aluminum polish may be used to polish small scratches and scuffs on the finish. Mild soap may be used also to clean the Sidebar.</p> <p><b>For gloss black finishes:</b> Mild soap may be used to clean the Sidebar.</p>	

The instruction here is for your reference only. We strongly recommend the professional installer for best result. We are not responsible for any damage caused by the installation. Thank you for choosing our product!

# Installation Instruction

Part#: IB14DAH0B

Application: For 2013 NISSAN PATHFINDER

Driver Side Installation Pictured



(Fig 1) Driver side front mounting  
Location pictured from below. Remove  
(3) rubber plugs from factory holes

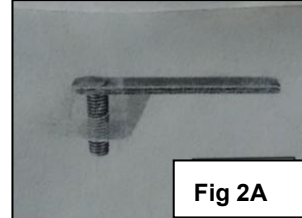


Fig 2A

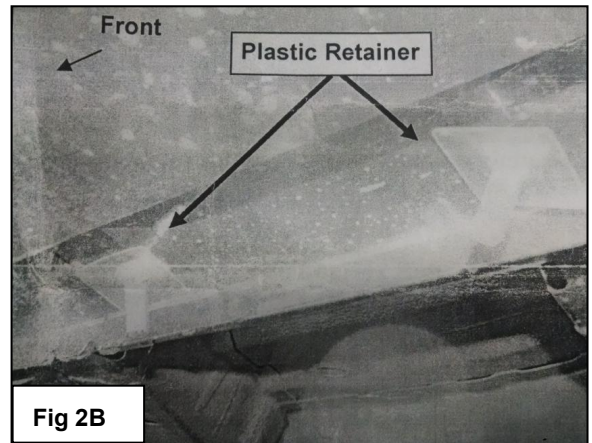


Fig 2B

M10 Flat Washer  
M10 Lock Washer  
M10 Hex Nut

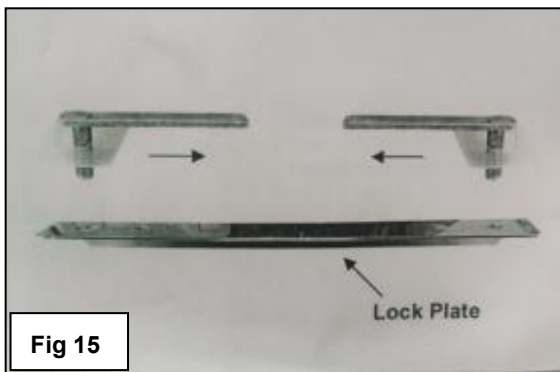


Fig 15

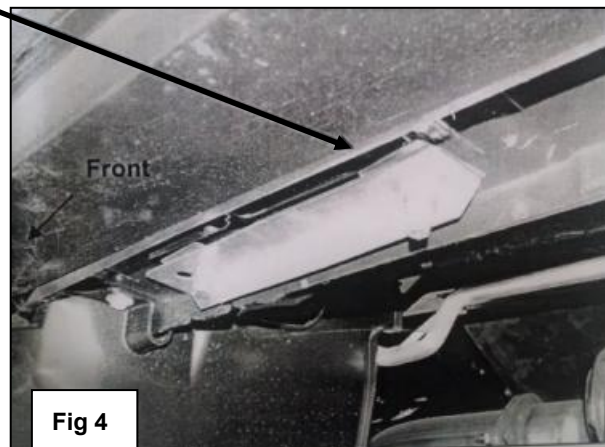


Fig 4

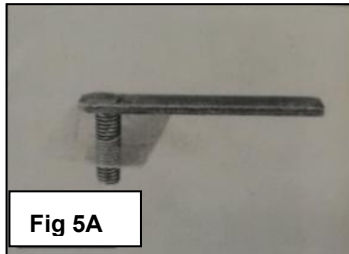
The instruction here is for your reference only. We strongly recommend the professional installer for best result. We are not responsible for any damage caused by the installation. Thank you for choosing our product!

# Installation Instruction

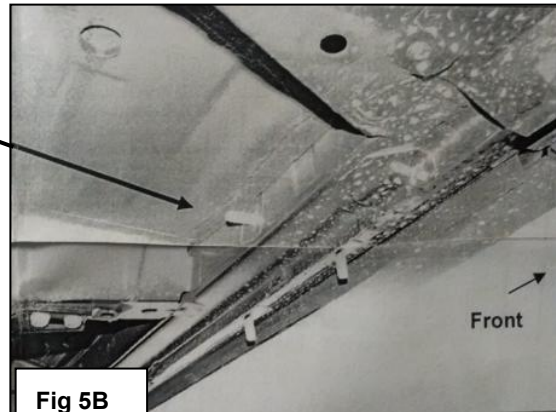
**Part#: IB14DAH0B**

**Application: For 2013 NISSAN PATHFINDER**

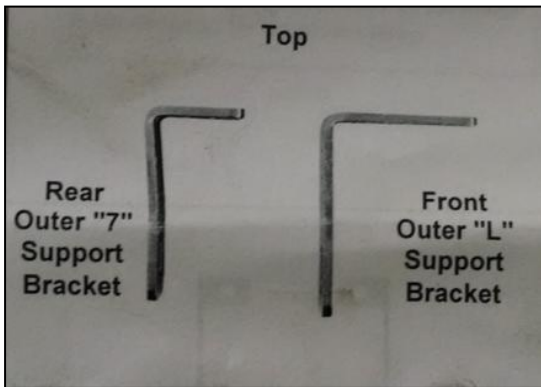
**Driver Side Installation Pictured**



**Fig 5A**

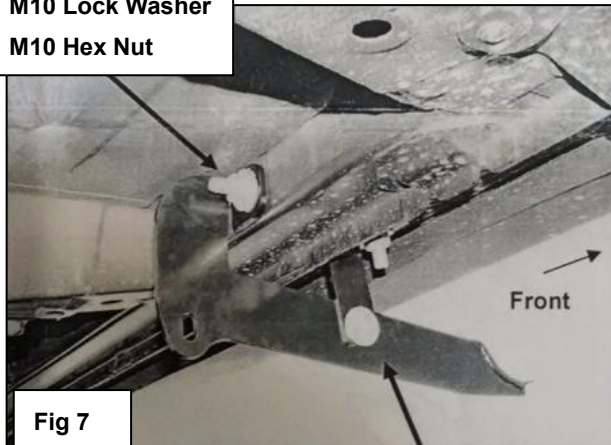


**Fig 5B**



**(Fig 6) Side view of Outer Support Brackets**

**M10 Flat Washer  
M10 Lock Washer  
M10 Hex Nut**



**Fig 7**

**M10 Flat Washer  
M10 Lock Washer  
M10 Hex Nut**

**M8x30mm Hex Bolt  
(2) M8 Large Flat Washers  
M8 Lock Washer  
M8 Hex Nut**



**Fig 8**

**M8x30mm Hex Bolt  
(2) M8 Large Flat Washers  
M8 Lock Washer  
M8 Hex Nut**

The instruction here is for your reference only. We strongly recommend the professional installer for best result. We are not responsible for any damage caused by the installation. Thank you for choosing our product!

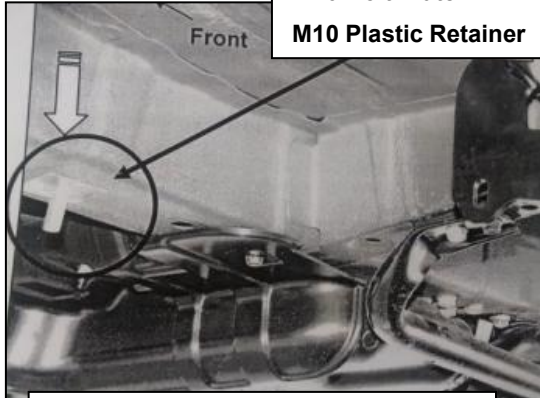


# Installation Instruction

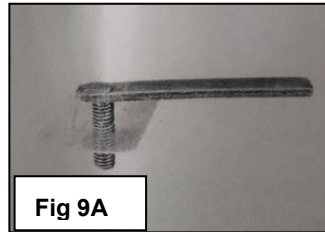
**Part#: IB14DAH0B**

**Application: For 2013 NISSAN PATHFINDER**

**Driver Side Installation Pictured**



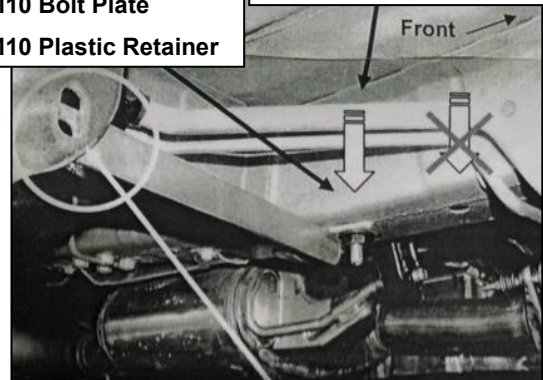
**(Fig 9B) Driver/Left inner location Pictured. Install Bolt Plate in forward Hole closest to tie down loop**



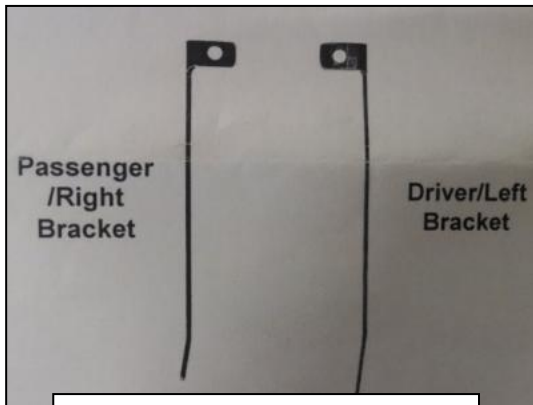
**Fig 9A**

**Passenger/right inner location Pictured. Install Bolt Plate in 2nd hole behind tie down loop**

**M10 Bolt Plate  
M10 Plastic Retainer**



**(Fig 10) Passenger/Right inner location pictured. Bolt Support Bracket to back side of Front Bracket**



**(Fig 11) Front Inner Support Brackets pictured from above**

**M8x30mm Hex Bolt  
(2) M8 Large Flat Washers  
M8 Lock Washer  
M8 Hex Nut**



**(Fig 12) Driver side Inner Front Support Bracket pictured. Bolt Support Bracket To front of Front Bracket**

**M10 Flat Washer  
M10 Lock Washer  
M10 Hex Nut**

The instruction here is for your reference only. We strongly recommend the professional installer for best result. We are not responsible for any damage caused by the installation. Thank you for choosing our product!

# Installation Instruction

Part#: IB14DAH0B

Application: For 2013 NISSAN PATHFINDER

Driver Side Installation Pictured



(Fig 13) Driver side rear mounting location pictured

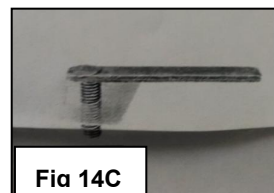


Fig 14C

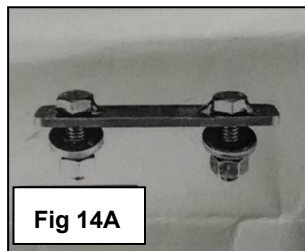


Fig 14A

Plastic Retainer

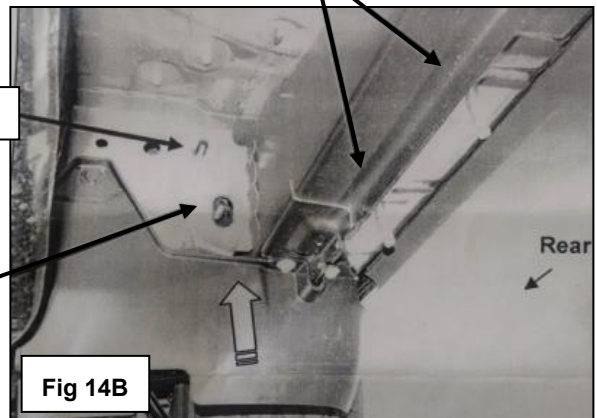


Fig 14B

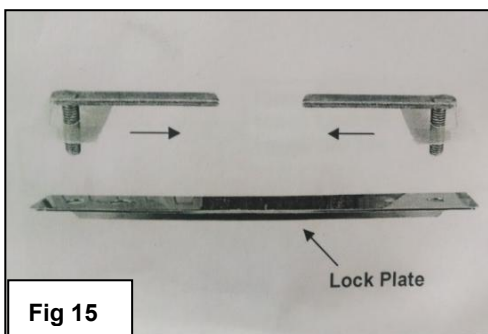


Fig 15

M10 Flat Washer  
M10 Lock Washer  
M10 Hex Nut



Fig 16

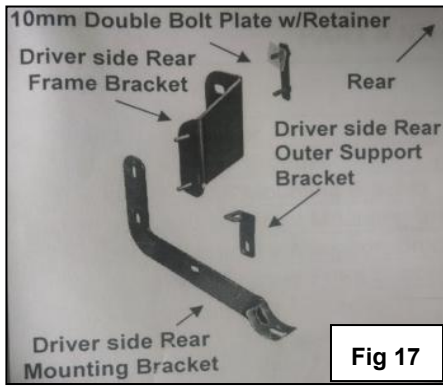
The instruction here is for your reference only. We strongly recommend the professional installer for best result. We are not responsible for any damage caused by the installation. Thank you for choosing our product!

# Installation Instruction

Part#: IB14DAH0B

Application: For 2013 NISSAN PATHFINDER

Driver Side Installation Pictured

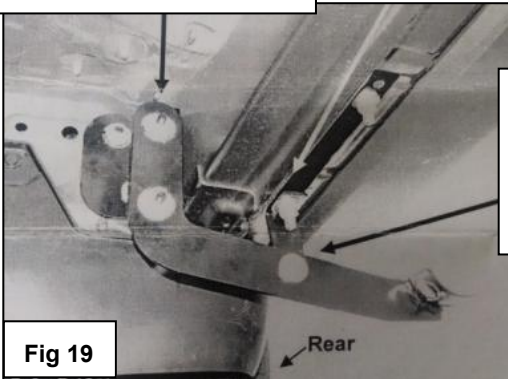


M10 Double Bolt Plate  
M10 Plastic Retainer  
(2) M10 Flat Washers  
(2) M10 Lock Washers  
(2) M10 Hex Nuts

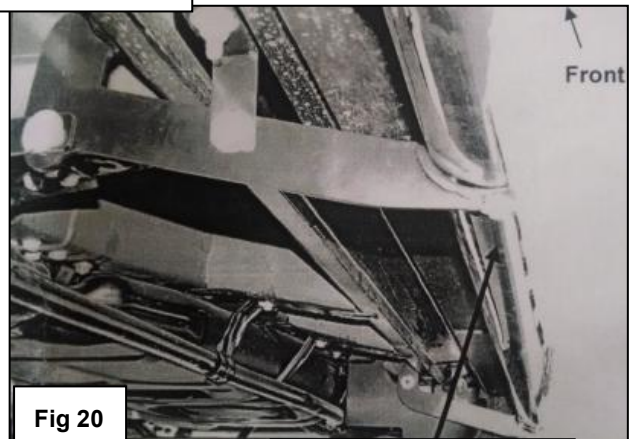
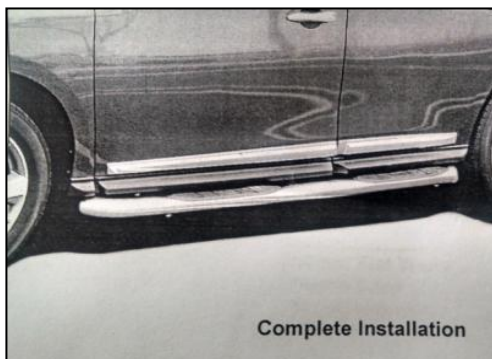


(2) M8 Large Flat Washers  
(2) M8 Lock Washers  
(2) M8 Hex Nuts

M10 Flat Washer  
M10 Lock Washer  
M10 Hex Nut



M8x30mm Hex Bolt  
(2) M8 Large Flat Washers  
M8 Lock Washer  
M8 Hex Nut



M8x25mm Hex Bolts  
M8x24mm STD Flat Washers  
M8 Lock Washers

The instruction here is for your reference only. We strongly recommend the professional installer for best result. We are not responsible for any damage caused by the installation. Thank you for choosing our product!