



iRunning Board Installation Instruction

Part#: IB08RCE2

Application: For 2016-2018 HONDA PILOT

PARTS LIST:

Item	QTY	Description	Item	QTY	Description
#01	2	STEP BOARD, Driver+Passenger	#06	12	M8 Flat Washers
#02	2	Driver Front Mounting Bracket (DFM/PFM)	#07	12	M8 Lock Washers
#03	2	Driver Center Mounting Bracket (DCM/PCM)	#08	12	M6 Square Head Bolts
#04	2	Driver Rear Mounting Bracket (DRM/PRM)	#09	12	M6 Flat Washers
#05	12	M8X1.25-25 Hex Bolts	#10	12	M6 Nylon Lock Nuts

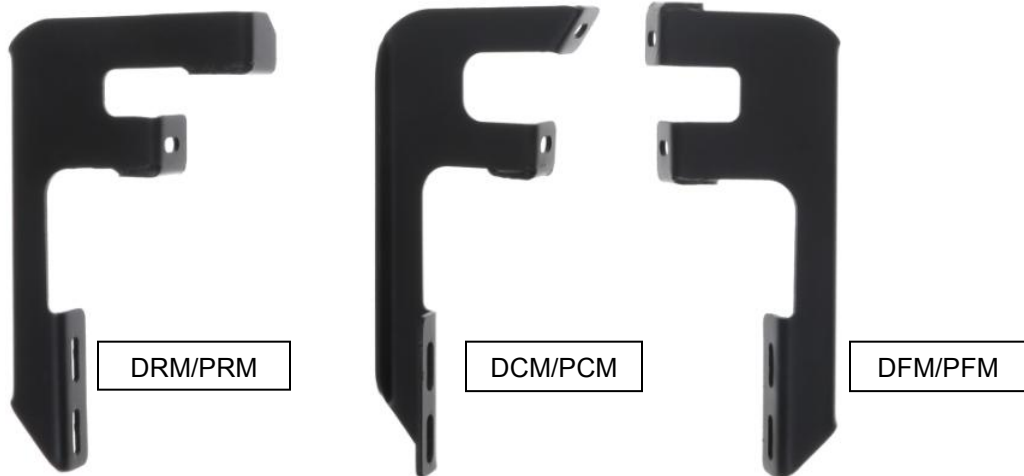

INSTALLATION INSTRUCTION:

1. Remove contents from box, verify if all parts listed are present and undamaged. Carefully read and understand all instructions before attempting installation.
2. Starting on the driver/left side front of the vehicle, locate the two factory 8mm threaded holes located in the bottom of the floor panel. **(Figure 1)**. NOTE: Brackets install in the factory running board mounting locations. Threaded holes may be covered with insulation. Clean mounting locations as required for proper Bracket installation.
3. Select (1) Front Mounting Bracket. NOTE: Brackets will fit left or right side. Attach the Bracket to the two threaded holes with (2) 8mm x 25mm Hex Bolts, (2) 8mm Lock Washers and (2) 8mm Flat Washers, **(Figure 2)**. Do not tighten hardware at this time.
4. Move to the center of the vehicle. Locate the two threaded holes in the bottom of the floor panel and body support panel, **(Figure 3)**. Repeat Steps 2&3 to attach (1) Center Bracket, **(Figures 4)**.
5. Next, move to the driver/left rear of the vehicle. Locate the holes in the bottom and inner side of the floor panel, **(Figure 5)**. Repeat Steps 2&3 to install (1) Rear Bracket, **(Figures 6)**.
6. Insert square head bolts as shown (3 per slot, 6 per Step board/Running board). **(Figures 7)**.
7. Attach Step board to brackets as shown. **(Figures 8)**. Make sure step board and brackets are properly aligned and tighten fasteners.
8. Repeat Installation for passenger side.
9. **INSTALLATION IS COMPLETE, SEE FIGURE 9.**

To protect your investment, wax this product after installing. Regular waxing is recommended to add a protective layer over the finish. Do not use any type of polish or wax that may contain abrasives that could damage the finish.

For Polished Finishes: Aluminum polish may be used to polish small scratches and scuffs on the finish. Mild soap may be used also to clean the Running Board.

For black finishes: Mild soap may be used to clean the Running Board.

iRunning Board Installation Instruction

Part#: IB08RCE2

Application: For 2016-2018 HONDA PILOT

Driver Side Installation Pictured

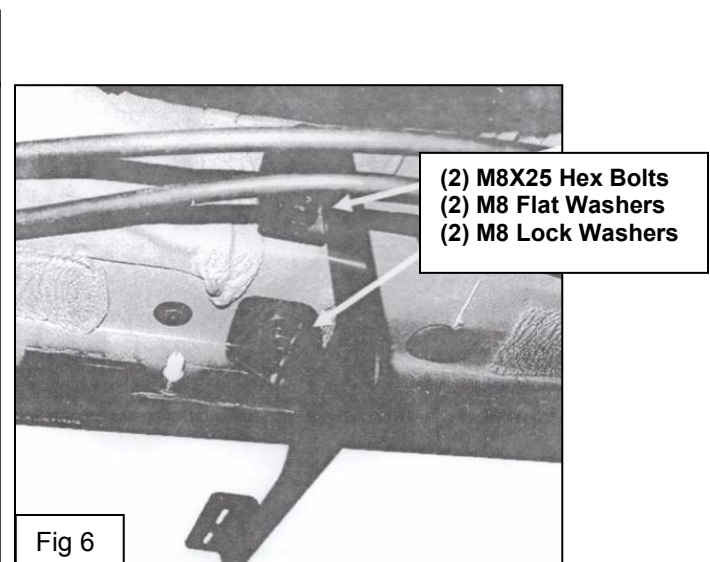
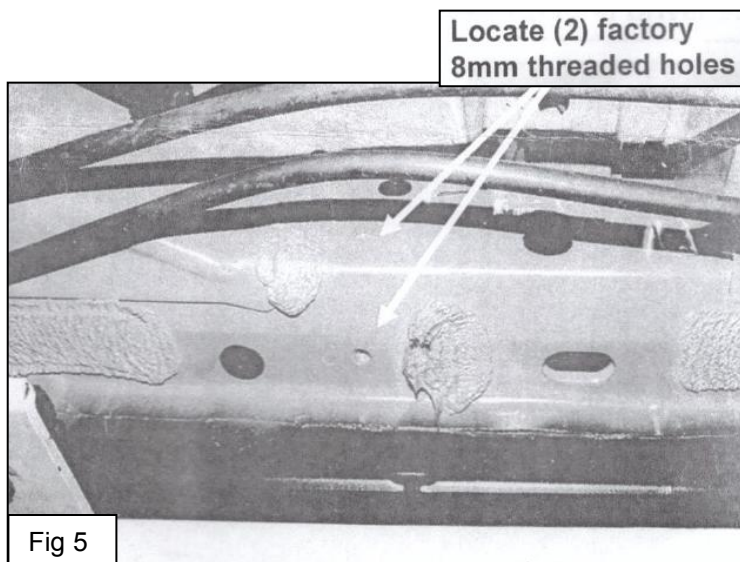
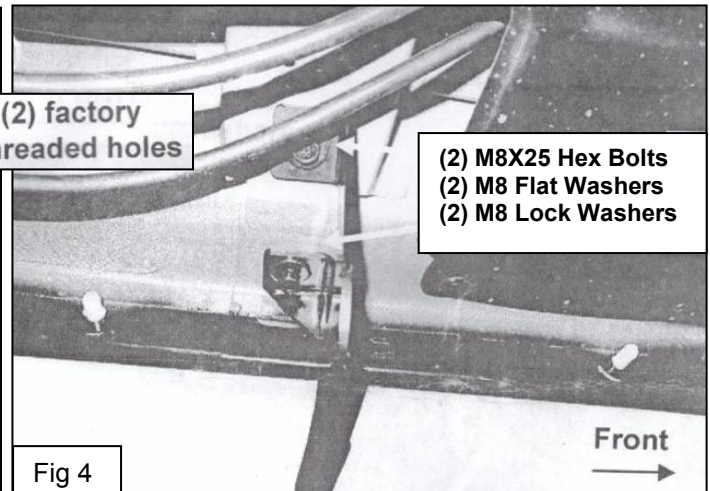
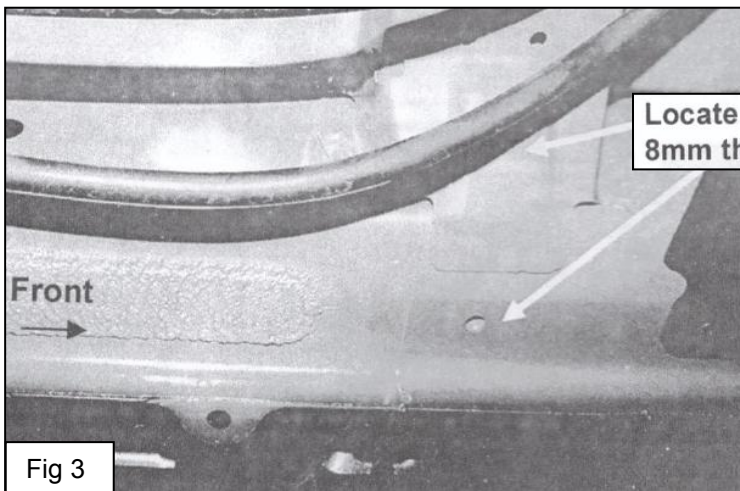
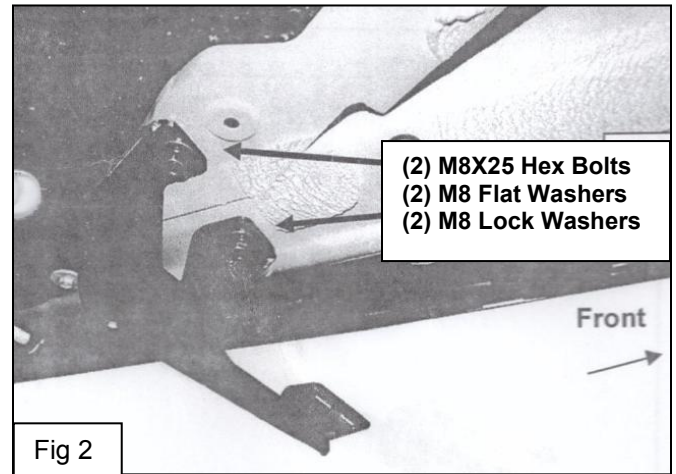
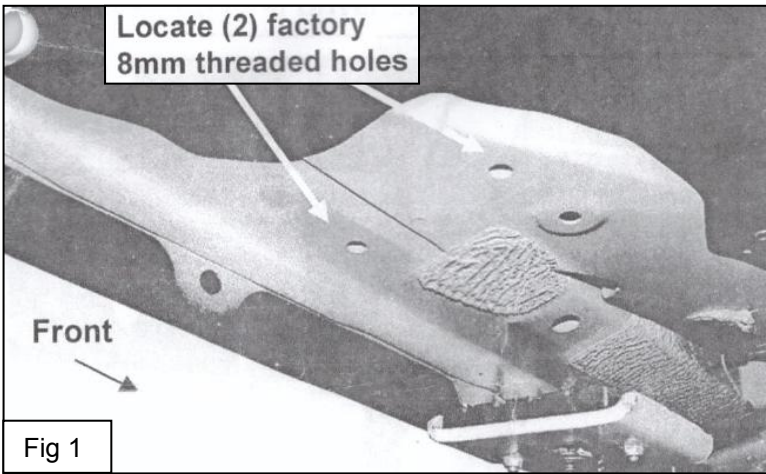

iRunning Board Installation Instruction

Part#: IB08RCE2

Application: For 2016-2018 HONDA PILOT

