

PARTS LIST:

Item	Qty	Description	Item	Qty	Description
#1	1	Driver/left Running Board	#12	1	8-1.25mm x 35mm Hex Bolt
#2	1	Passenger/right Running Board	#13	13	8-1.25mm x 25mm Hex Bolt
#3	5	Passenger Side/Driver Side Front Mounting Brackets	#14	20	8mm x 24mm x 2mm Flat Washer
#4	1	Driver/left Side Rear Mounting Bracket	#15	13	8mm Lock Washers
#5	2	10mm x 35mm Button Head Bolt Plate	#16	6	8mm Nylon Lock Nuts
#6	2	10mm Plastic Retainer	#17	12	8mm Clip Nuts
#7	4	10mm x 30mm x 2.5mm Flat Washer	#18	1	8-1.25mm Hex Nut
#8	2	10-1.5mm Nylon Lock Nuts	#19	12	6-1.0mm x 20mm T-Bolts
#9	3	8mm U-Bolts	#20	12	6mm x 22mm OD x 2mm Flat Washers
#10	1	8mm Threaded Insert Tool Handle	#21	12	6mm Nylon lock Nuts
#11	1	8-1.25mm Threaded Insert			

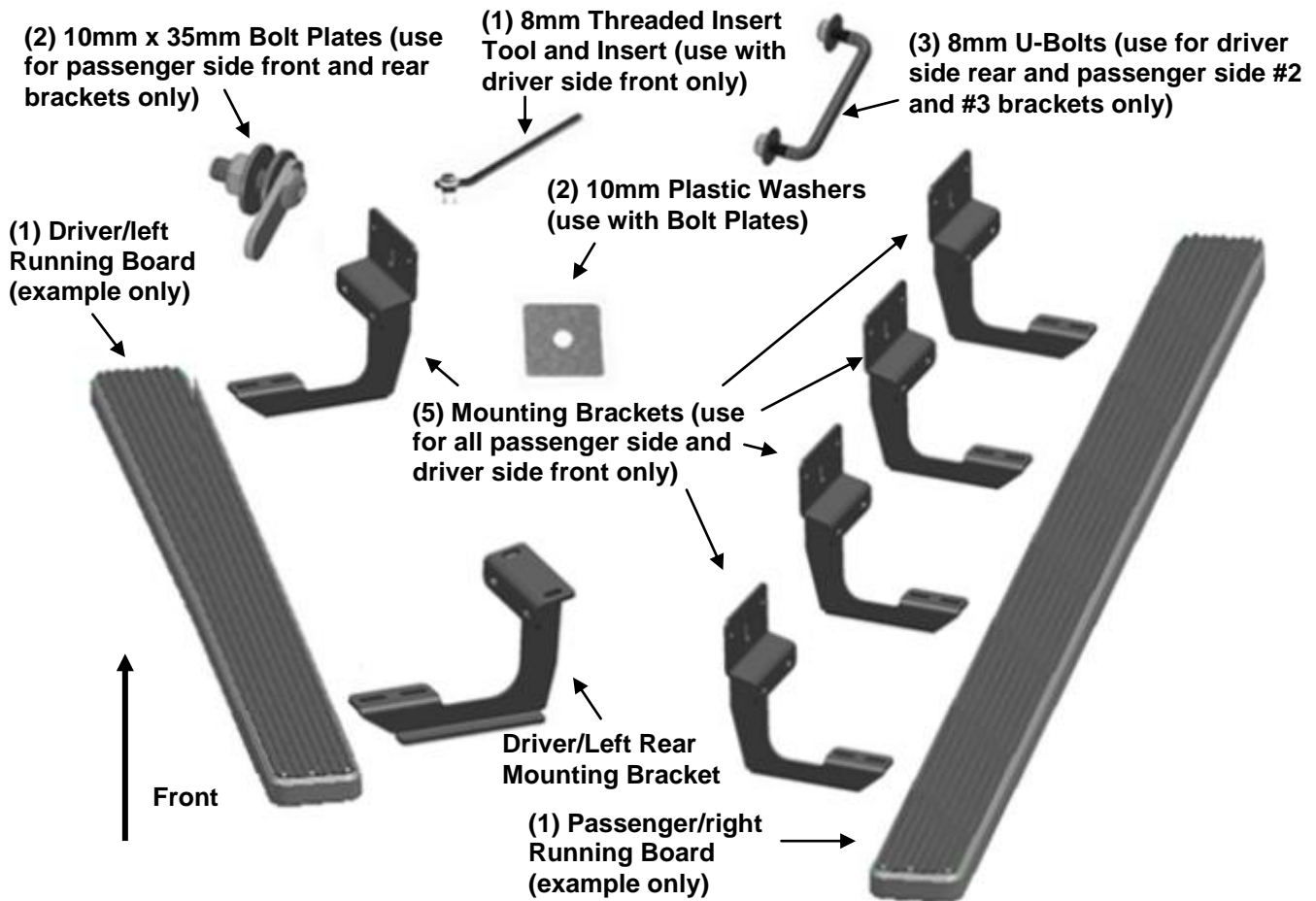

PROCEDURE:

REMOVE CONTENTS FROM BOX. VERIFY ALL PARTS ARE PRESENT. READ INSTRUCTIONS CAREFULLY BEFORE STARTING INSTALLATION. DRILLING IS REQUIRED. ASSISTANCE IS RECOMMENDED.

1. Start the installation under the passenger side of the vehicle. Release the lower clips from the plastic trim along the bottom of the body, **(Figure 1)**. **NOTE:** From below, insert a small or medium sized flat blade screwdriver into the rectangular hole in the center of the clip. Carefully release each side (inside to outside, not front to back) of the plastic clip and pull the rectangular center pin down from the clip, **(Figure 2)**. Do not twist the clip, gently pull it straight down once it is released. It is not necessary to completely remove the trim, only release the clips attaching the bottom of the trim to the vehicle.
2. Locate the factory hole approximately 24" back from the front of the body, **(Figure 3)**. Remove excess undercoating from all mounting locations so that Brackets will install flat against body panel and pinch weld.

3. Select (1) 10mm Bolt Plate, (1) 10mm Flat Washer and (1) 10mm Plastic Retainer, **(Figure 4)**. Thread the Retainer part way onto the Bolt Plate. Insert the Bolt Plate into the hole and tighten the Retainer against the body panel. Slide the 10mm Flat Washer onto the end of the Bolt Plate, **(Figure 5)**. **IMPORTANT:** The Plastic Retainer is designed to prevent the Bolt Plate from falling into the body panel and to aid in Bracket installation.
4. Select (1) passenger side Mounting Bracket. Line up the long slot in the center of the Bracket with the Bolt Plate and Flat Washer. Attach the Bracket to the Bolt Plate with (1) 10mm Flat Washer, (1) 10mm Lock Washer and (1) 10mm Hex Nut, **(Figure 6)**. Push the Bracket up tight against the bottom of the body and temporarily tighten the Hex Nut.
5. Mark the location of the (2) bottom slots in the Bracket onto the pinch weld, **(Figure 6)**. Remove the Bracket. Use a 3/8" drill bit to drill (2) holes through the pinch weld only. **NOTE:** Drill the holes as far away from the bottom edge of the pinch weld as possible. **IMPORTANT:** Do not drill through the welds in the pinch weld. Slide the Bracket forward or back to move the slots away from the factory spot welds. Do not drill into or through the outer plastic rocker panel cover.

IMPORTANT! Any cutting or drilling tool may break or shatter. Government regulations require safety glasses & equipment at all times when cutting or drilling.

6. Select (2) 8mm Clip Nuts. Slide the Clip Nuts over the pinch weld with the nut toward the outside, **(Figure 7)**. Reattach the Bracket to the Bolt Plate, **(Step 4)**. Attach the Bracket to the pinch weld with (2) 8mm x 25mm Hex Bolts, (2) 8mm Lock Washers and (2) 8mm Flat Washers, **(Figure 8)**. Leave hardware loose at this time.
7. Move along the body to the 2nd mounting location. Determine if the vehicle is equipped with factory mounting studs along the body panel.

Models without factory studs:

- Locate the (2) factory holes in the side of the body panel, **(Figure 9)**. Insert (1) 8mm Long U-Bolt into and through the (2) holes, **(Figure 10)**. Thread 8mm Plastic Retainers onto the ends of the U-Bolt to hold it in place. Select (1) Passenger side Bracket. Attach the Bracket to the U-Bolt with (2) 8mm Flat Washers, (2) 8mm Lock Washers and (2) 8mm Hex Nuts, **(Figures 11 & 12)**. Repeat **Steps 5 & 6** to drill and attach the bottom of the Bracket to the back of the pinch weld, **(Figure 15)**. Repeat to install (1) Bracket in the 3rd mounting location, **(Figures 13 & 15)**.

Models with factory studs:

- Attach (1) passenger side Bracket to the factory studs with (2) 8mm Flat Washers, (2) 8mm Lock Washers and (2) 8mm Hex Nuts, **(Figures 14 & 15)**. Repeat **Steps 5 & 6** to drill and attach the bottom of the Bracket to the back of the pinch weld. Repeat to install (1) Mounting Bracket in the 3rd mounting location.
8. Continue along the side of the vehicle to the 4th mounting location, **(Figure 16)**. Repeat **Steps 2—6** to install (1) passenger side Mounting Bracket in the 4th (last) mounting location, **(Figures 17 & 18)**.
 9. Carefully unwrap and select the passenger side Running Board. Insert (8) 6mm T-Bolts into the slots in the end of the channels, (4 Bolts per channel), on the bottom of the Running Board, **(Fig. 19)**. Hold the Running Board up in approximate position and slide the T-Bolts down to line up with the Mounting Brackets. Tilt the Board up at a slight angle and push back against the vehicle until the T-Bolts fit into the slots on the Brackets. Secure the Board to the Brackets with (8) 6mm Flat Washers and (8) 6mm Hex Nuts, **(Fig. 20)**. Do not tighten hardware at this time.
 10. Level and adjust the Running Board and fully tighten all hardware. Reinstall the plastic trim along the bottom of the body. **IMPORTANT:** Minor trimming may be required around 8mm Clip Nuts. Temporarily remove the Running Board. Use a sharp knife or hacksaw blade to trim plastic as required.
 11. Move to the driver side of the vehicle. Repeat **Step 1, (Figures 1 & 2)**, to release the clips attaching the plastic trim to the bottom of the driver side. Identify the front bracket mounting location approximately 10" back from the front corner of the body, **(Figure 21)**.
 12. Select (1) passenger/driver side front Bracket. Hold the Bracket firmly in position against the bottom and side of the body panel and mark the top left hole location onto the inner body panel. Also mark the (2) lower mounting locations onto the back of the pinch weld, **(Figure 21)**. **IMPORTANT:** Do not drill

through the welds in the pinch weld. Slide the Bracket forward or back to move the slots away from the factory spot welds. Do not drill into or through the outer plastic rocker panel cover.

13. Move the Bracket out of the way and drill a 7/16" hole through the body panel for the top of the Bracket, **(Figures 21 & 24B)**. Select (1) 8mm Threaded Insert, (1) 8mm x 35mm Hex Bolt, (1) 8mm Hex Nut, (1) 8mm Flat Washer and (1) 8mm Insert Tool. Thread the Hex Nut onto the Hex Bolt. Assemble the Tool as pictured in **Figure 22**. Use a 13mm wrench to hold the Hex Bolt to prevent it from spinning. Turn the Hex Nut counter-clockwise to pull/expand the insert in the hole, **(Figure 23)**. Tighten the Hex Nut until the Insert is fully installed, **(Figures 24A & 24B)**. Do not overtighten the Hex Nut.
14. Next, repeat **Steps 5 & 6** to drill the pinch weld and attach the bottom of the Bracket to the pinch weld, **(Figures 24B & 25)**. Attach the top of the Bracket to the previously installed Threaded Insert with (1) 8mm x 25mm Hex Bolt, (1) 8mm Lock Washer and (1) 8mm Flat Washer, **(Figure 25)**. Leave hardware loose at this time.
15. Continue along the side of the body to the driver side rear mounting location approximately 24" back from the front corner of the body, **(Figures 21 & 26)**. Select the unique driver side rear Mounting Bracket. Hold the Bracket firmly against the bottom and back of the body panel. Slide the Bracket forward or back as necessary to avoid drilling through any welds on the pinch weld. Mark all (4) locations to drill.
16. Drill (2) 7/16" holes through the bottom of the body panel as marked, **(Figure 27)**. Next, repeat **Step 5** to drill through the pinch weld to attach the bottom of the Bracket. Insert (1) 8mm Long U-Bolt into and through the (2) drilled 7/16" holes. Select (1) Passenger side Bracket. Attach the top slots on the Bracket to the U-Bolt with (2) 8mm Flat Washers, (2) 8mm Lock Washers and (2) 8mm Hex Nuts, **(Figure 28)**. Repeat **Step 6** to drill and attach the bottom of the Bracket to the back of the pinch weld. Leave all hardware loose at this time.
17. Select the driver side Running Board. Repeat Steps 9 & 10 to attach the Running Board to the (2) Brackets. (**IMPORTANT:** Just need (4) T-bolts and (4) 6mm Flat Washers and (4) 6mm Hex Nuts on the driver side)
18. Level and adjust the Running Board and fully tighten all hardware. Reinstall the plastic trim along the bottom of the body. **IMPORTANT:** Minor trimming may be required around 8mm Clip Nuts. Use a sharp knife or hacksaw blade to trim plastic as required.
19. Do periodic inspections to the installation to make sure that all hardware is secure and tight.

To protect your investment, wax this product after installing. Regular waxing is recommended to add a protective layer over the finish. Do not use any type of polish or wax that may contain abrasives that could damage the finish. Mild soap may be used also to clean the Running Board.

Passenger/right Side Installation Pictured

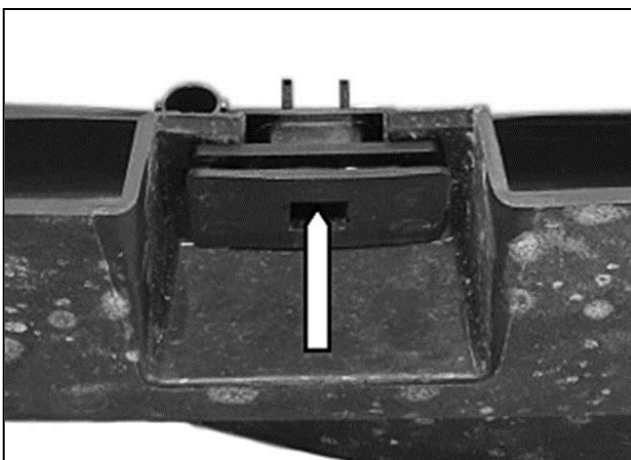

(Fig 1) Insert flat blade screwdriver into square opening in center of plastic clip to release

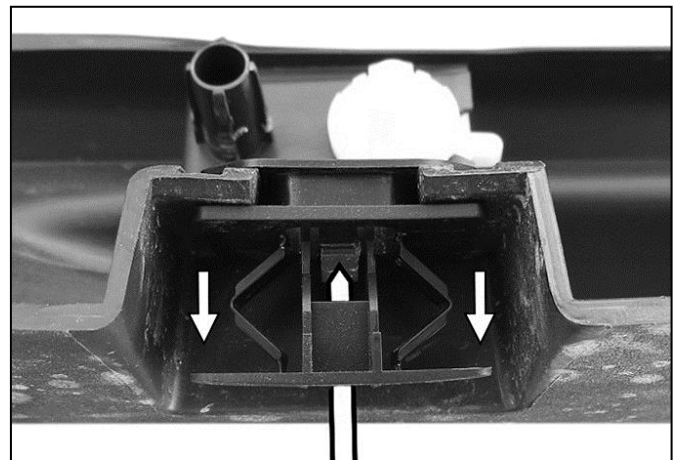

(Fig 2) Release both sides of clip and pull insert to release. Do not try to pull the clip out of the trim, only release clip as pictured

Passenger/right Side Installation Pictured

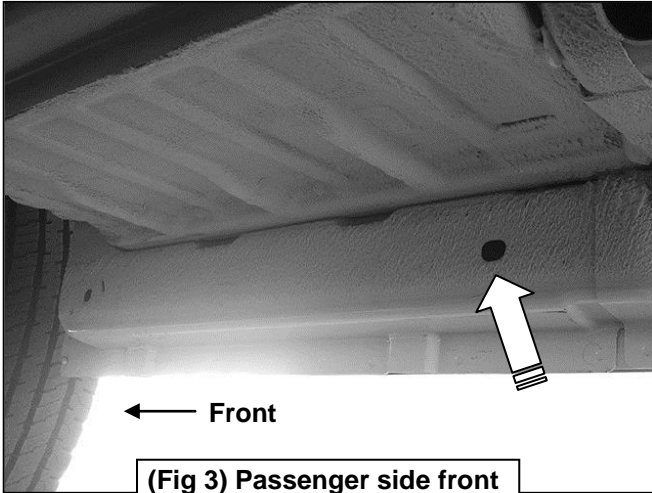

(Fig 3) Passenger side front mounting location pictured



(Fig 4) Bolt Plate with Plastic Retainer

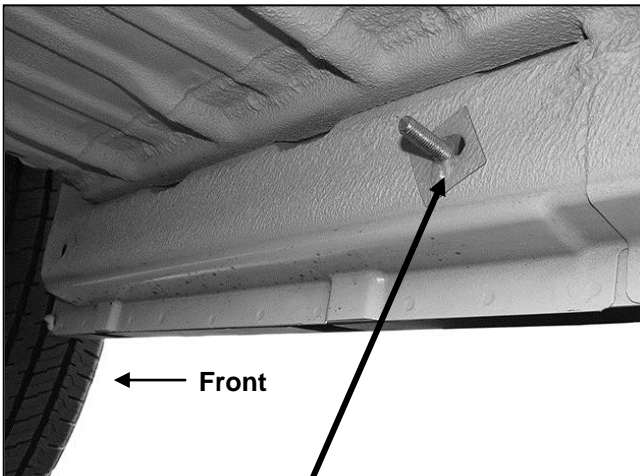

(Fig 5) Tighten Plastic Retainer to hold Bolt Plate

(2) 10mm Flat Washers
10mm Lock Washer
10mm Hex Nut

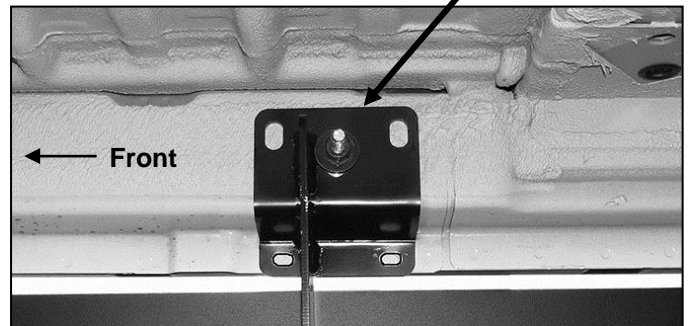

(Fig 6) Push Bracket up tight against body panel. Mark location of bottom slots onto pinch weld

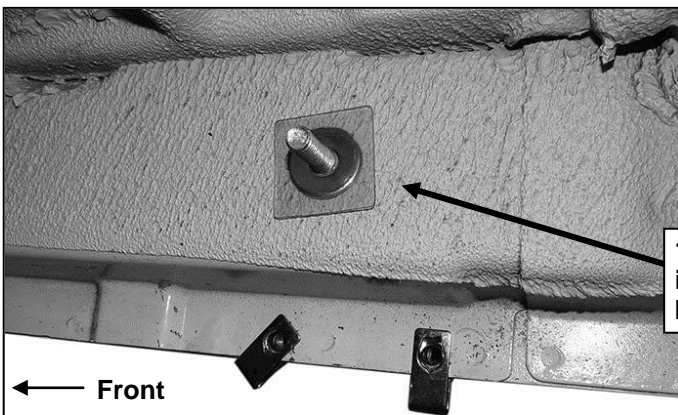

10mm Flat Washer
installed as a spacer
between Bracket and body

(Fig 7) Drill 3/8" holes through pinch weld. Slide 8mm Clip Nuts onto pinch weld over holes

Passenger/right Side Installation Pictured

(2) 10mm Flat Washers
10mm Lock Washer
10mm Hex Nut

(2) 8mm x 25mm Hex Bolts
(2) 8mm Lock Washers
(2) 8mm Flat Washers

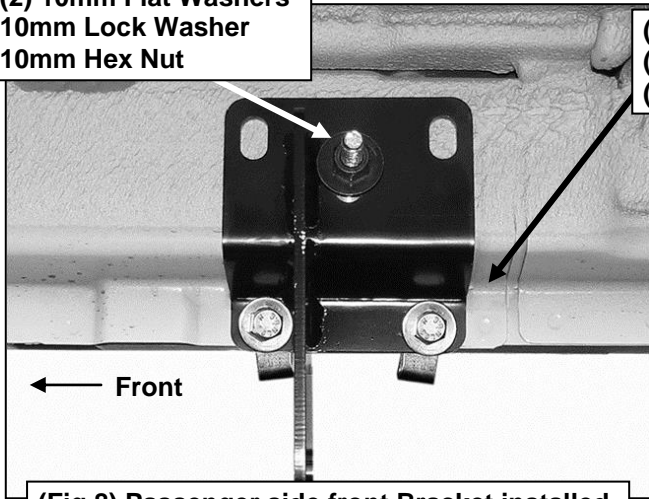

(Fig 8) Passenger side front Bracket installed

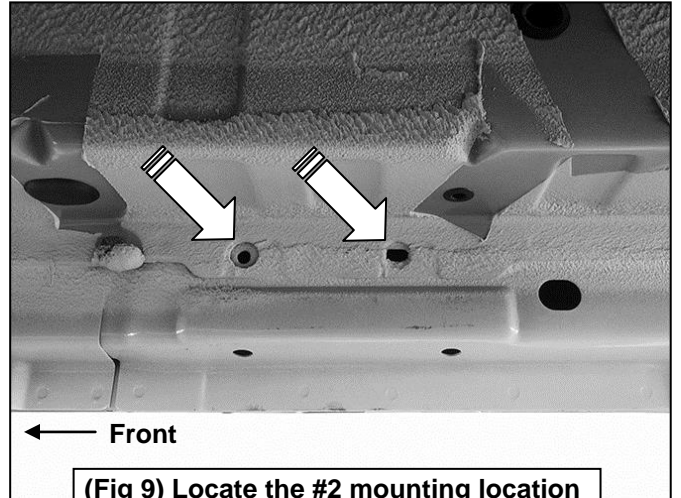

(Fig 9) Locate the #2 mounting location for Bracket. Insert 8mm U-Bolt into and out factory holes in body panel

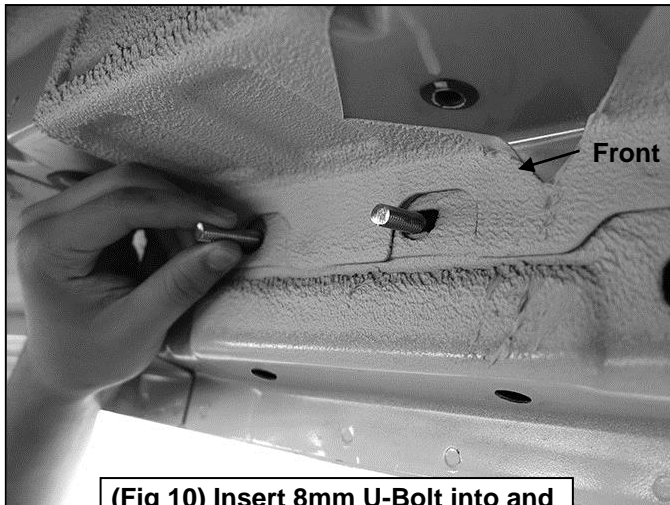

(Fig 10) Insert 8mm U-Bolt into and out factory holes in body panel

8mm U-Bolt
(2) 8mm Flat Washers
(2) 8mm Nylon Lock Nuts

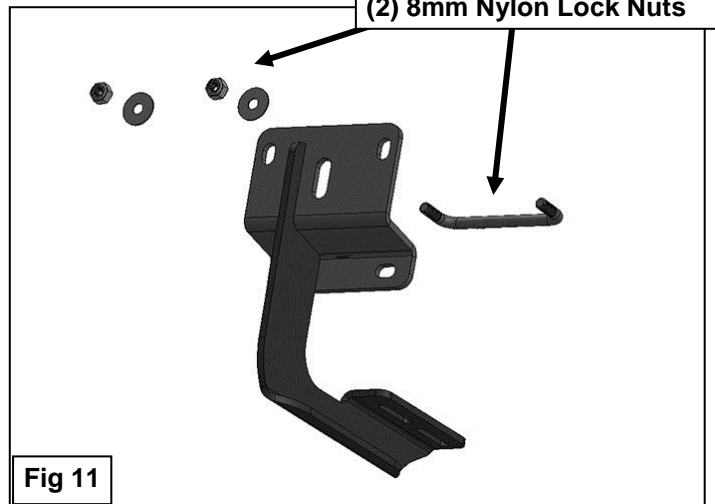
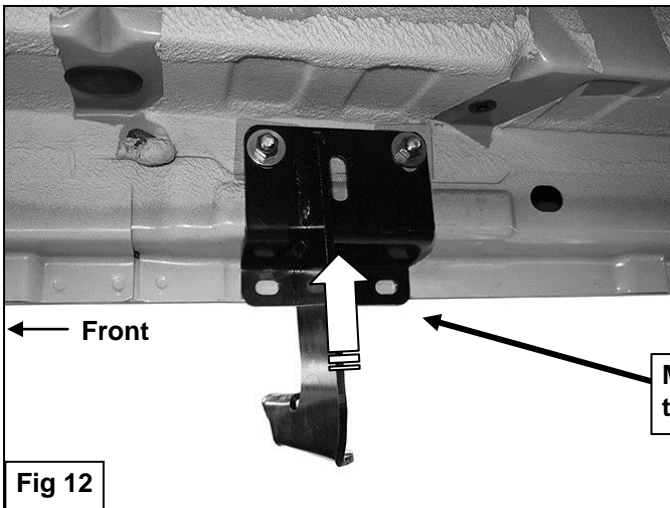

Fig 11



Mark and drill 3/8" holes through pinch weld

Fig 12

Passenger/right Side Installation Pictured

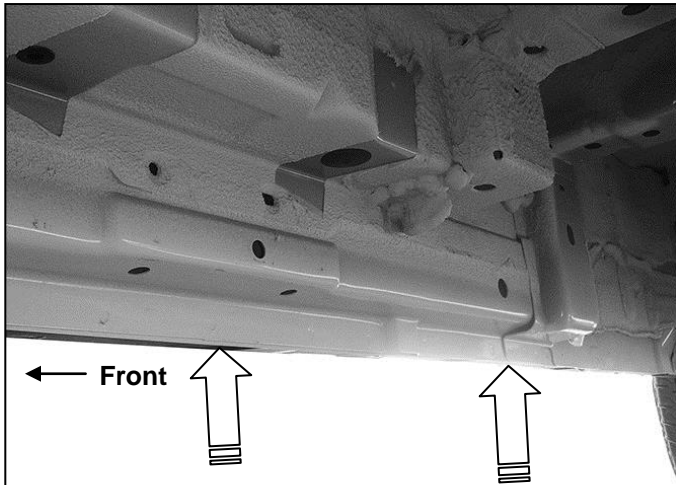

(Fig 13) #3 and rear mounting locations pictured

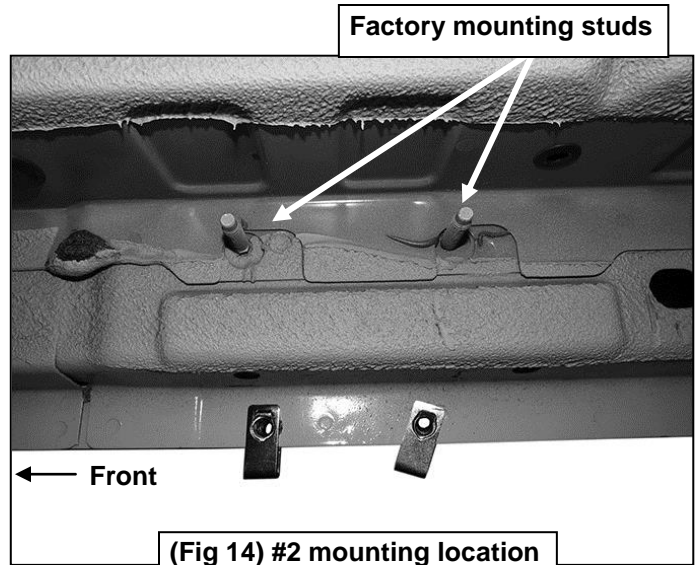

(Fig 14) #2 mounting location with factory mounting studs

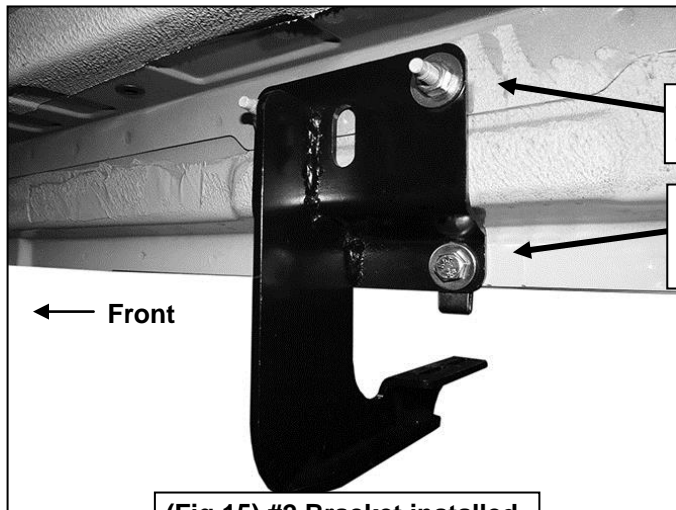

- (2) 8mm Flat Washers
- (2) 8mm Nylon Lock Nuts

- (2) 8mm x 25mm Hex Bolts
- (2) 8mm Lock Washers
- (2) 8mm Flat Washers

(Fig 15) #2 Bracket installed

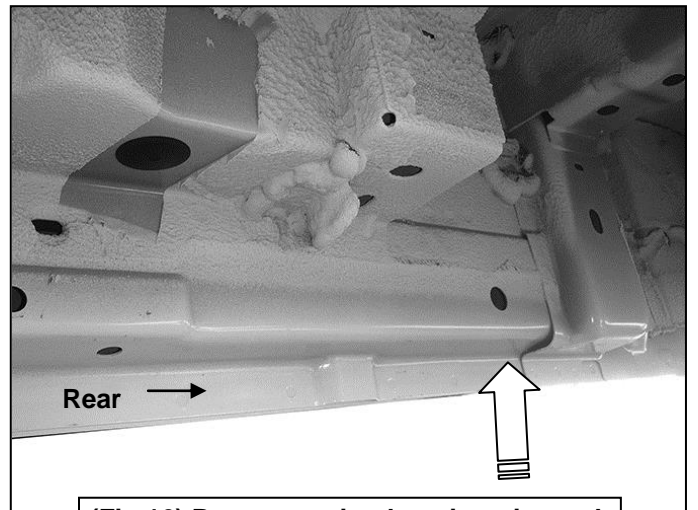

(Fig 16) Rear mounting location pictured

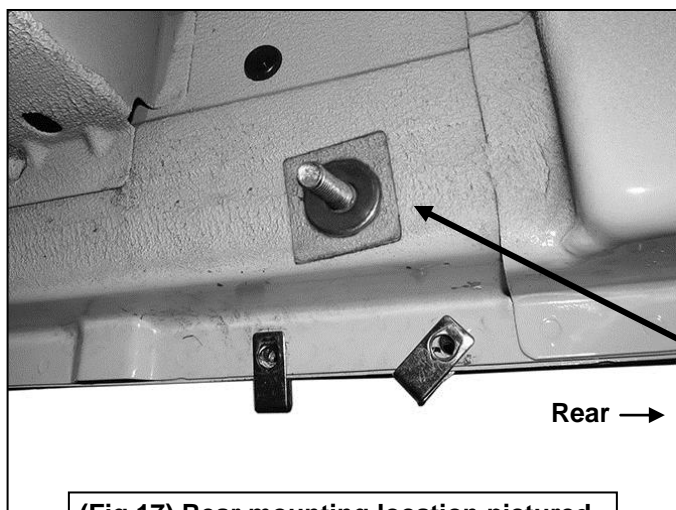

10mm Flat Washer installed as a spacer between Bracket and body

(Fig 17) Rear mounting location pictured

Passenger/right Side Installation Pictured

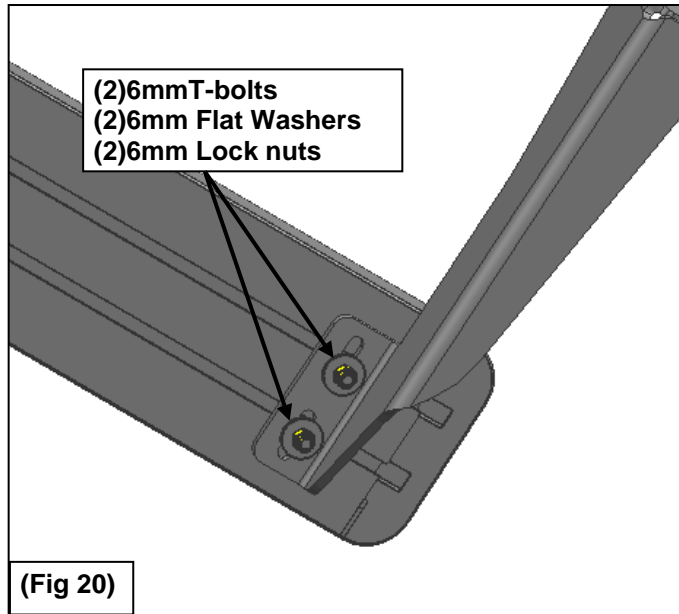
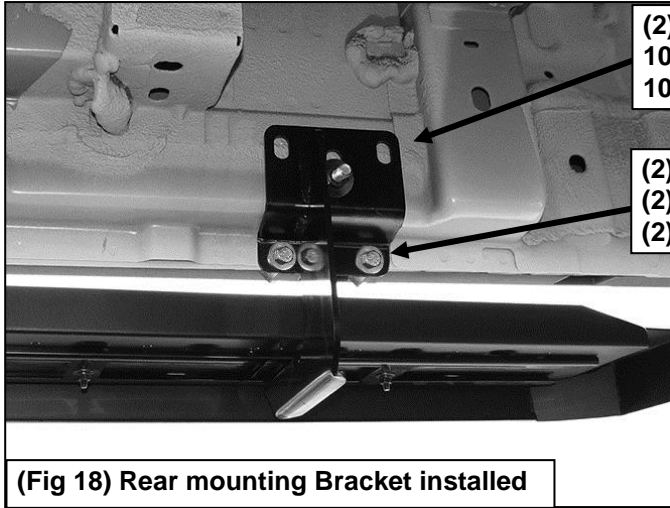

Driver/left Side Installation Pictured

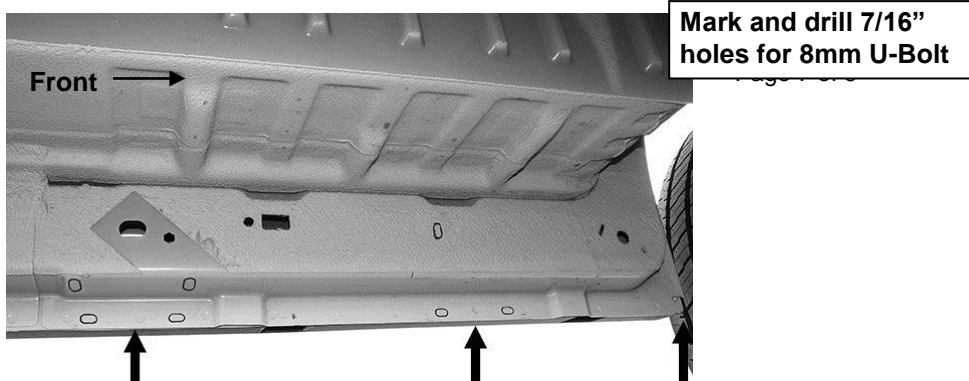

Driver/left Side Installation Pictured

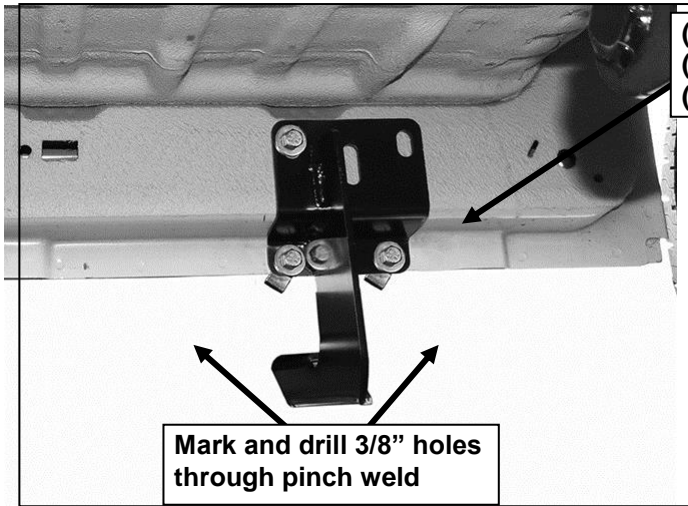

- (3) 8mm x 25mm Hex Bolts
- (3) 8mm Lock Washers
- (3) 8mm Flat Washers

Mark and drill 3/8" holes through pinch weld

(Fig 21) Driver side front and rear mounting locations

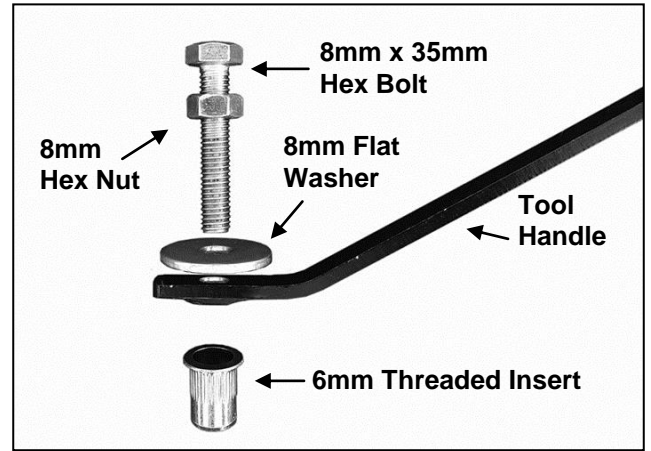

(Fig 22) Assemble 6mm Insert Tool

Hold 6mm Hex Bolt in position with wrench. Turn 6mm Hex Nut clockwise to "pull" insert



(Fig 23) Assemble 6mm Insert Tool



(Fig 24A) Fully installed Threaded Insert

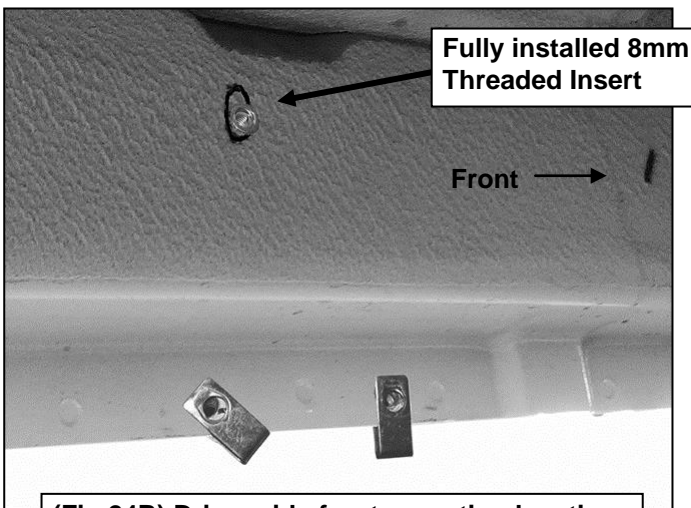

(Fig 24B) Driver side front mounting location

Mark and drill 7/16"
holes for 8mm U-Bolt

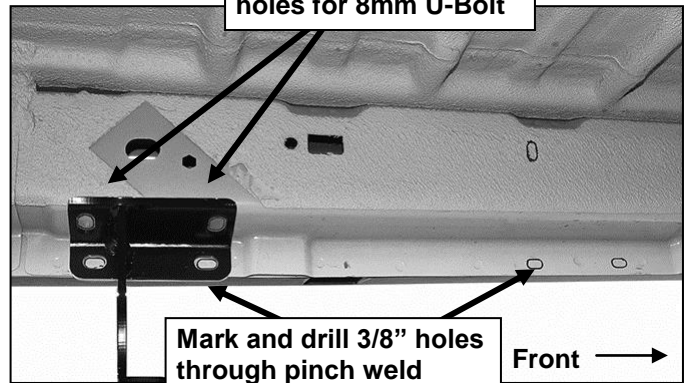

Mark and drill 3/8"
holes
through pinch weld

(Fig 26) Hold the Bracket up tight against
the bottom of the body panel. Mark the (4)
mounting location onto the body panel

Insert 8mm U-Bolt into and
out of the drilled holes

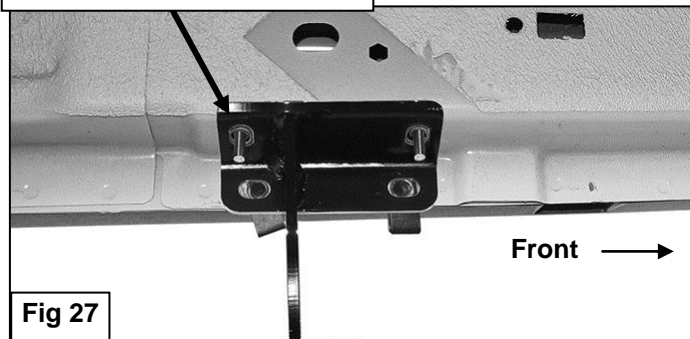

(4) 8mm Flat Washers
(4) 8mm Nylon Lock Nuts

