



For 2007-2018 Chevy/GMC Silverado/Sierra 1500 Crew Cab(Incl. 2019 Silverado 1500 LD & 2019 Sierra 1500 Limited)/
2007-2019 Chevy/GMC Silverado/Sierra 2500/3500 Crew Cab (Incl. Diesel Models With DEF Tanks)Not For 07 Classic Model

Installation Instructions for IA03SJG1B by APS Auto Parts Specialist Inc.

Application: For 2007-2018 Chevy/GMC Silverado/Sierra 1500 Crew Cab(Incl. 2019 Silverado 1500 LD & 2019 Sierra 1500 Limited)/
2007-2019 Chevy/GMC Silverado/Sierra 2500/3500 Crew Cab (Incl. Diesel Models With DEF Tanks)Not For 07 Classic Model

Estimated Time: 1 to 2 hours



The instruction here is for your reference only. We strongly recommend the professional installer for best result. We are not responsible for any damage caused by the installation. Thank you for choosing our product!

For 2007-2018 Chevy/GMC Silverado/Sierra 1500 Crew Cab(Incl. 2019 Silverado 1500 LD & 2019 Sierra 1500 Limited)/
2007-2019 Chevy/GMC Silverado/Sierra 2500/3500 Crew Cab (Incl. Diesel Models With DEF Tanks)Not For 07 Classic Model

PARTS LIST:

Item	QTY	Description	Item	QTY	Description
#1	2	Driver/ Passenger Side Bar	#11	13	M8 Hex Bolts
#2	3	Driver Front/Center/Rear Mounting Bracket(DFM/DCM/DRM)	#12	13	M8 Flat Washers
#3	3	Driver Front/Center/Rear Support Bracket(DFB/DCB/DRB)	#13	13	M8 Lock Washers
#4	1	Passenger Front Mounting Bracket (PFM)	#14	11	M8 Clip-On Nuts
#5	1	Passenger Front Support Bracket (PFS)	#15	12	M10X1.5-75 Carriage Bolts
#6	2	Passenger Center/Rear Mounting Bracket (PCM/PRM)	#16	12	M10 Flat Washers
#7	2	Passenger Center/Rear Support Bracket (PCB/PRB)	#17	12	M10 Lock Washers
#8	6	2-Hole Support Bracket	#18	12	M10 Hex Nuts
#9	1	M8 Bolt Plate	#19	10	M8X1.25 Hex Flange Nuts
#10	1	M8 Nylon Lock Nut	#20	10	M8X1.25-20 Inner Hex Bolts

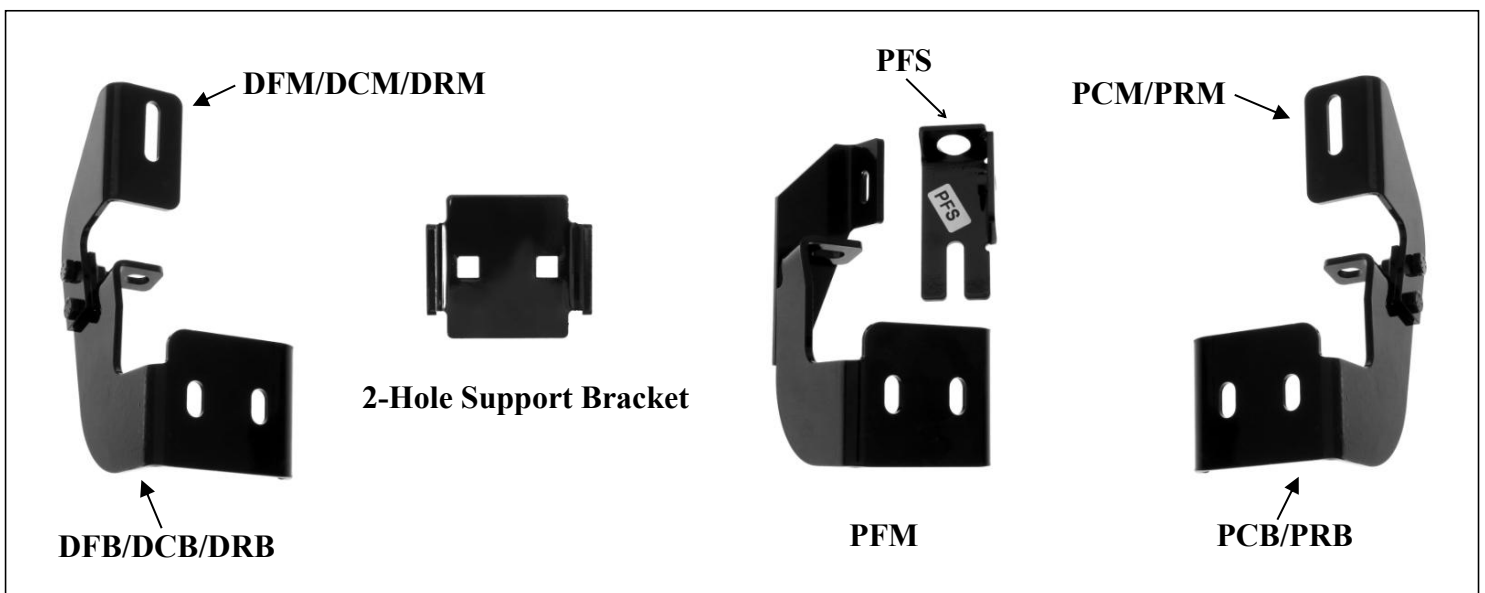

PROCEDURE:

REMOVE CONTENTS FROM BOX. VERIFY ALL PARTS ARE PRESENT. READ INSTRUCTIONS CAREFULLY BEFORE STARTING INSTALLATION. ASSISTANCE IS RECOMMENDED. ON MODELS WITH DEF TANK, SELECT A FLAT, LEVEL AREA FOR INSTALLATION.

1. Start the installation under the driver side of the vehicle. Locate the 4 tabs along the bottom edge of the body, (pinch weld). Mounting Brackets will bolt to the 1st, 2nd, (just in front of center of cab), and 4th mounting tabs, (Figure 1). Directly above each tab is a top mounting location on the side of the body panel. Hold a Bracket up in place to help determine the mounting holes to use along the body.
2. Determine the correct procedure for your model year and each Bracket location.

Bottom mounting location on the edge of the pinch weld.

Flat tab on pinch weld with factory installed weld nut:

Thread hex bolt into weld nut from the backside-down to clear paint from threads, (Figure 2).

Flat tab on pinch weld with hole:

Select (1) 8mm Clip Nut. Slide the Clip Nut over the tab with the nut facing up behind the tab, (Figures 3—5). Line up threaded nut with hole in tab. Repeat for each mounting location.

Top mounting location on the side of the body panel.

Models with factory installed threaded insert in body panel:

Thread 8mm Hex Bolt into threaded insert to clear paint as required, (Figures 2 & 3).

Large and small hole in side of body panel:

Remove the rubber plug from the larger hole, (**Figure 4**). Select (1) 8mm Clip Nut. Slide the Clip Nut into the larger hole. Line up the threaded nut with the smaller hole, (**Figure 5**).

3. Assemble mounting bracket and support bracket as shown(**Fig 6**). Bolt the Mounting Bracket to the Clip Nuts and/or the factory threaded holes with (2) M8 Hex Bolts, (2) M8 Lock Washers and (2) M8 Flat Washers, (**Figures 6a & 7**). Snug but do not fully tighten the hardware.
4. Repeat **Steps 1—3** to install the (2) remaining driver side Brackets, (**Figure 7**).
5. Select the Driver Side Bar. Slip (2) M10X1.5-75 Carriage Bolts into each 2-Hole Support Brackets ,and insert the 2-Hole support bracket into the Driver Side Bar.(**Figure 20**). Carefully position the Driver Side Bar onto the (3) Mounting Brackets. **IMPORTANT:** Do not slide the Bar on the Brackets or damage to the finish may result. Attach the Driver Side Bar to the Mounting Brackets with (2) M10 Hex Nuts,(2)M10 lock washers and (2)M10 flat washers, (**Figure 21**). Do not tighten hardware.
6. Level and adjust the Bar and tighten all hardware. **NOTE: Torque all M10 X1.5-75 Carriage Bolts to 22~25 lb-ft. Don't over tighten,or the aluminum square bars will be damaged by the brackets.**
7. Move to the passenger side of the vehicle. On the passenger side, determine if the vehicle is equipped with a plastic diesel exhaust fluid (DEF) tank, (**Figures 8 & 9**).

Models without DEF tank, skip to Step 8.

Models with DEF tank: The tank sits close to the side of the body. With specialized tools, the passenger front upper and lower Bracket can be installed but room is limited. It may be easier to drop the tank down to access the inner side of the body panel for upper bracket installation. Tank will not need to be removed, only dropped down for access to mounting location. **IMPORTANT:** If tank is full, it will be very heavy and assistance is highly recommended to avoid injury or damage to the vehicle or the tank. It is recommended that installation is performed when the DEF tank is low on fluid before dropping the tank.

- a. On models with plastic lower tray under the tank, remove the (3) hex bolts attaching the tray to the frame, (**Figure 8**), and remove the tray. and remove tray. **2017 2500/3500 models:** Remove the (4) hex bolts attaching the plastic cover to DEF tank, (**Figure 9A**) and remove the plastic cover, (**Figure 9B**).
 - b. Release the tank filler hose. Release the plug for the sending unit on the top of the tank.
 - c. Support the tank with a floor jack. Place a smooth flat surface, (wooden block for example), between the floor jack and the tank to avoid damaging the plastic tank. Do not push up on the tank; only support the weight of the tank with the jack.
 - d. Remove the (2) bolts securing the tank straps to the vehicle, (**Figure 10**). Tilt the straps to release from the brackets. Slowly lower the tank until the top of the tank is almost visible. Use blocks or stands to support the tank while installing the front Upper and Lower Brackets.
 - e. Proceed to **Step 8**.
8. Locate the first tab on the edge of the pinch weld on the passenger side, (**Figures 2—4, 12 & 14**). Select the Upper Bracket, (**Figure 11**). Repeat **Steps 2 & 3** to attach the passenger front Upper Bracket to the side of the body panel, (**Figure 12**). Do not tighten hardware at this time.
 9. Line up the hole in the bottom of the Upper Bracket with the hole in the tab on the pinch weld.
 - a. **Models with a weld-nut:** Slide the Bracket over the weld-nut, (**Figure 12**). Attach the Lower Bracket to the bottom of the body and weld-nut with (1) 8mm Hex Bolt, (1) 8mm Lock Washer and (1) 8mm Flat Washer, (**Figures 15 & 16**). Leave loose at this time.
 - b. **Models with flat tab and hole:** Insert the 8mm Bolt Plate down through the hole in the Upper Bracket and mounting tab, (**Figures 13 & 14**). Attach the Lower Bracket to the bottom of the body and Bolt Plate with (1) 8mm Flat Washer and (1) 8mm Nylon Lock Nut, (**Figures 15 & 16**). Leave loose at this time.
 10. Line up the side tab on the Lower Bracket with the threaded hole in the side of the Upper Bracket. Attach the Lower Bracket to the Upper Bracket with (1) 8mm Hex Bolt, (1) 8mm Lock Washer and (1) 8mm Flat Washer, (**Figure 16**). Leave loose at this time.
 11. Repeat **Steps 1—3** for the (2) remaining passenger side Bracket installations.

For 2007-2018 Chevy/GMC Silverado/Sierra 1500 Crew Cab(Incl. 2019 Silverado 1500 LD & 2019 Sierra 1500 Limited)/
2007-2019 Chevy/GMC Silverado/Sierra 2500/3500 Crew Cab (Incl. Diesel Models With DEF Tanks)Not For 07 Classic Model

- a. **2017 2500/3500 DEF tank models:** Locate the 2nd tab bracket location along the bottom edge of the body, (pinch weld), (**Figure 17**). Hold the DEF cover in place and mark the 2nd Bracket location onto the cover, (**Figure 18**). Use a sharp knife or hacksaw blade to carefully cut a slot in the plastic cover to clear the 2nd Bracket, (**Figure 19**). Remove as little plastic as possible.
12. Repeat **Steps 5 & 6** to install the passenger Side Step, (**Figure 20**).
13. Once the Side Steps are installed and all hardware fully tightened, reinstall the DEF tank and cover, if equipped, as described in **Step 7 & 11**.
14. Do periodic inspections to the installation to make sure that all hardware is secure and tight.

FINISH PROTECTION

Products have a high quality finish that must be cared for like any other exposed finish on the vehicle. Protect the finish with a non-abrasive automotive wax, (e.g. Pure Carnauba) on a regular basis. The use of any soap, polish or wax that contains an abrasive is detrimental, as the compounds scratch the finish and open it to corrosion.

Driver/Left Side Installation Pictured

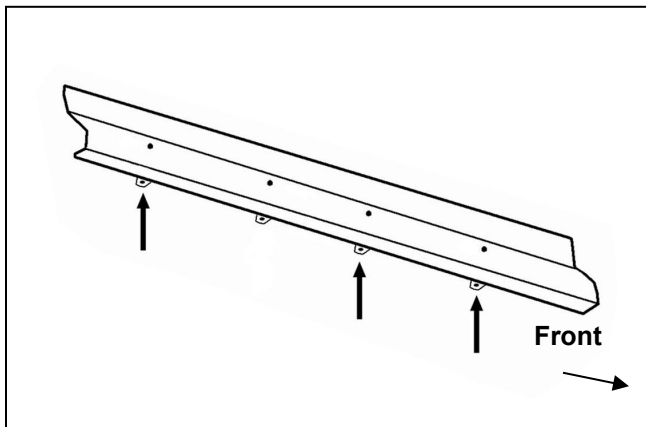

(Fig 1) Back of driver side (3) mounting locations

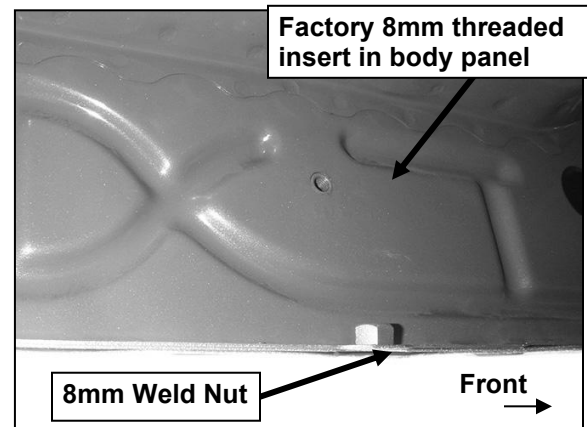

(Fig 2) Passenger side front mounting location

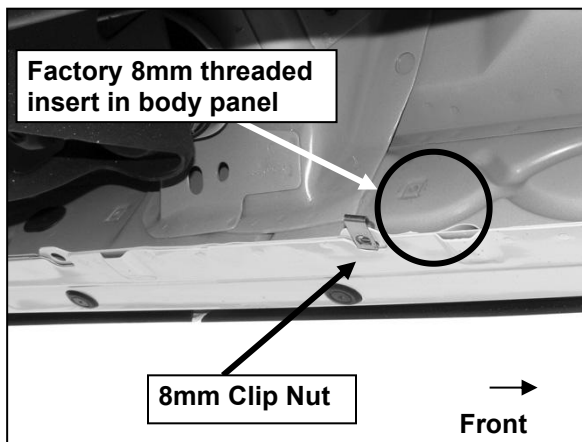

(Fig 3) Driver side 2nd mounting location

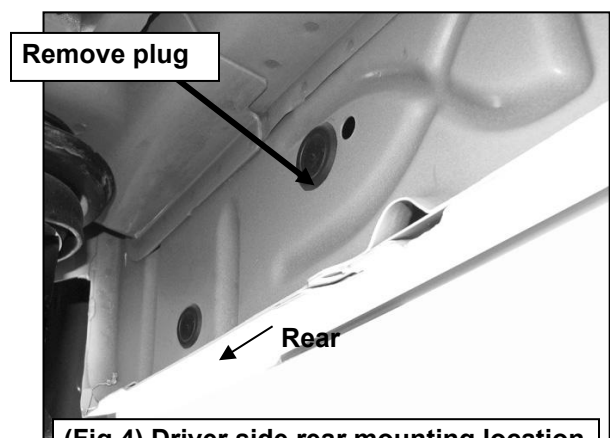

(Fig 4) Driver side rear mounting location

For 2007-2018 Chevy/GMC Silverado/Sierra 1500 Crew Cab(Incl. 2019 Silverado 1500 LD & 2019 Sierra 1500 Limited)/
 2007-2019 Chevy/GMC Silverado/Sierra 2500/3500 Crew Cab (Incl. Diesel Models With DEF Tanks)Not For 07 Classic Model

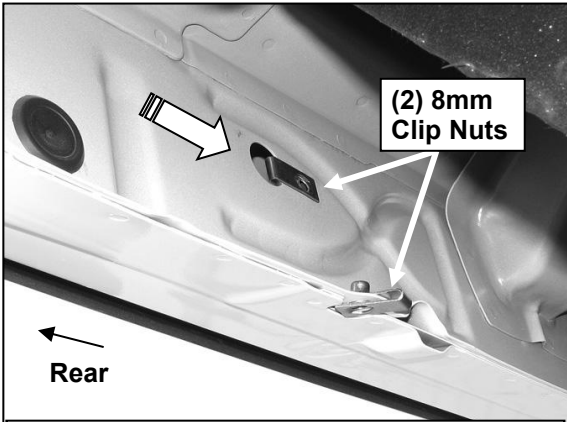

(Fig 5) Driver side rear mounting location

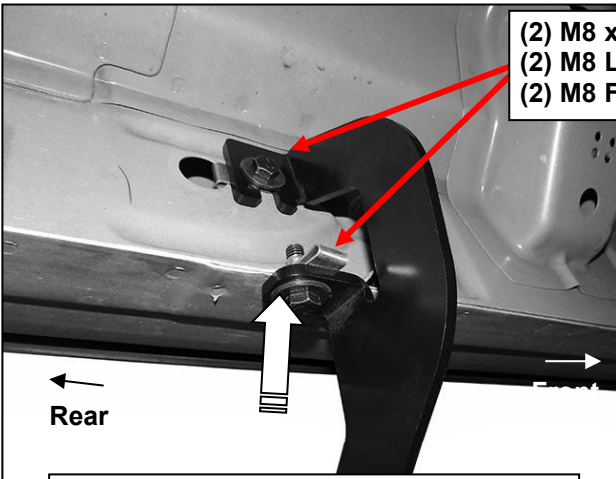
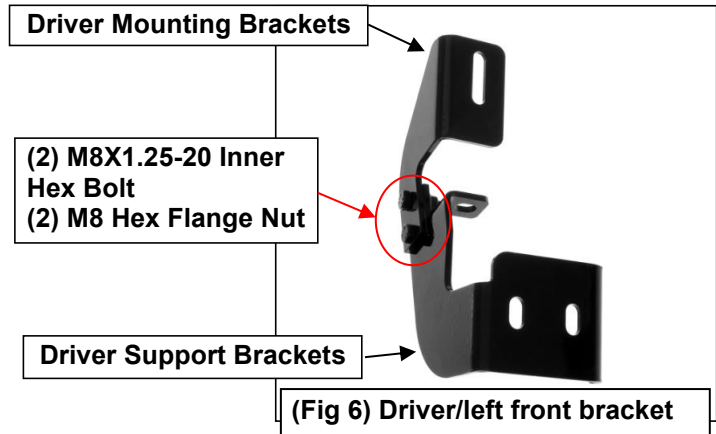

(Fig 7) Driver/left rear bracket installed

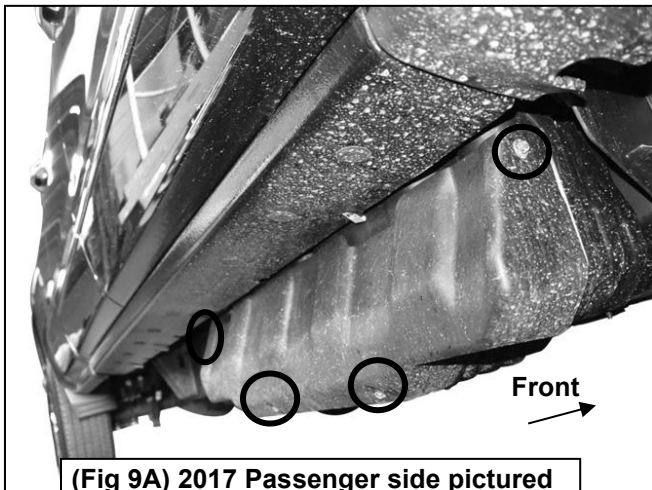
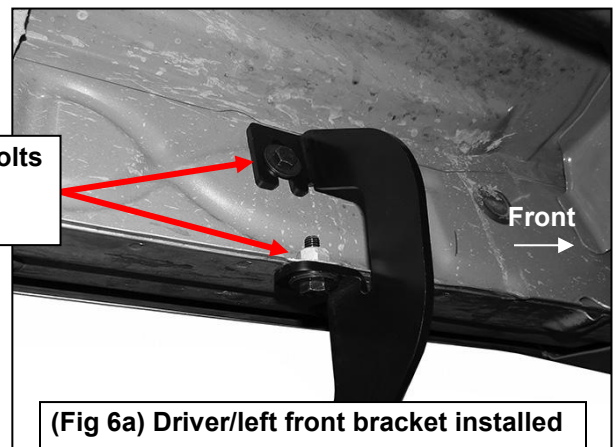

(Fig 9A) 2017 Passenger side pictured with DEF plastic tank cover. Remove (4) hex bolts to remove plastic cover

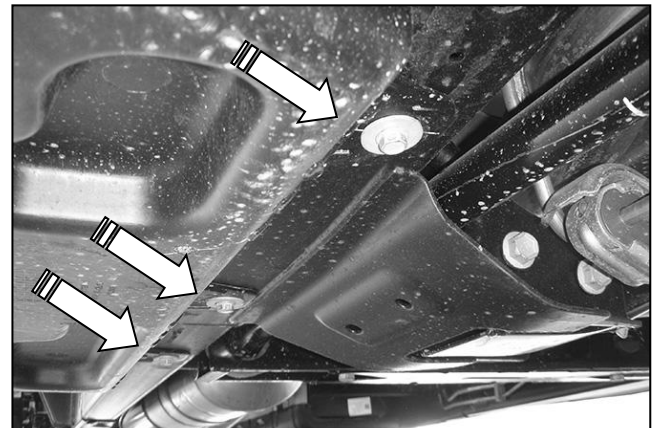

(Fig 8) 07-16 Passenger side front pictured with DEF tank cover. Remove (3) hex bolts to remove cover



(Fig 9B) 2017 Passenger side DEF cover

For 2007-2018 Chevy/GMC Silverado/Sierra 1500 Crew Cab(Incl. 2019 Silverado 1500 LD & 2019 Sierra 1500 Limited)/
2007-2019 Chevy/GMC Silverado/Sierra 2500/3500 Crew Cab (Incl. Diesel Models With DEF Tanks)Not For 07 Classic Model

Passenger/right Side Installation Pictured

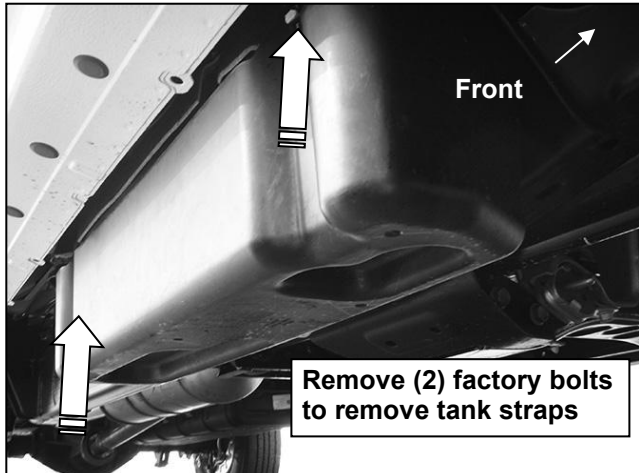

(Fig 10) 07-16 Passenger side DEF tank and cover

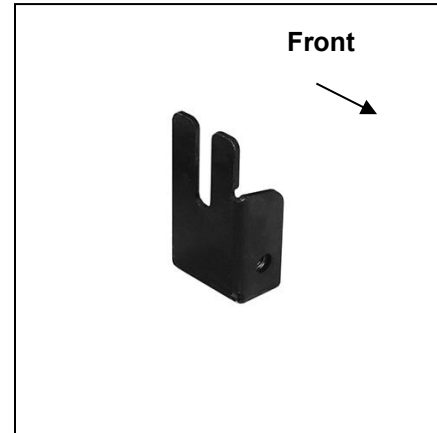

(Fig 11) Passenger/right Front Upper Bracket (all models)

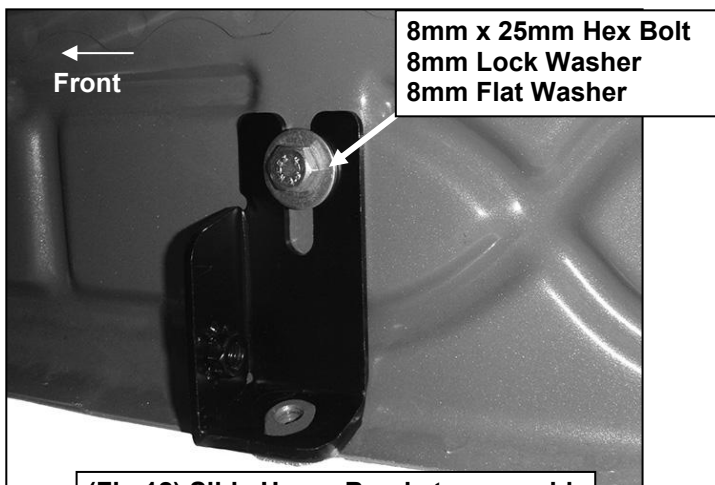

(Fig 12) Slide Upper Bracket over weld nut if equipped-also see Figure 2



(Fig 13) 8mm x 35mm Bolt Plate

On models with flat tab (see Fig 3, 4 and 15), insert 8mm Bolt Plate (Fig 12) down through Upper Bracket and mounting tab

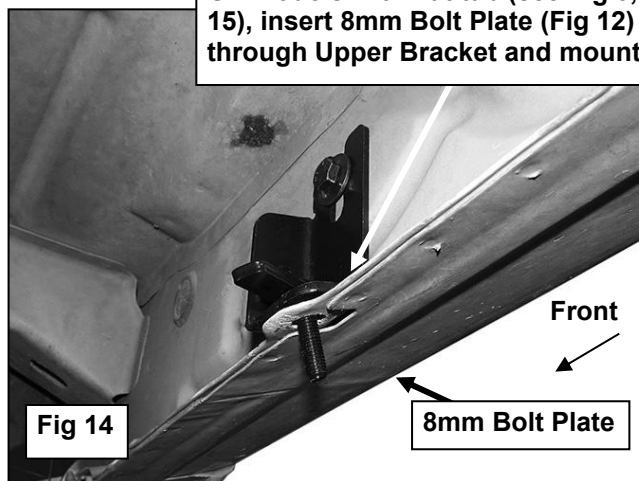
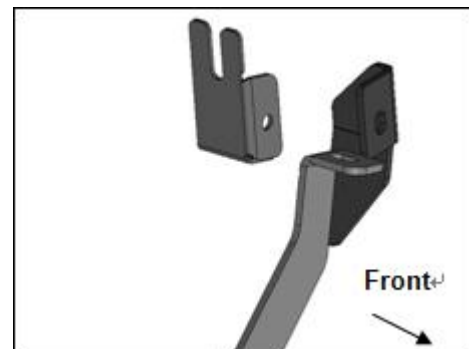

Fig 14



(Fig 15) Passenger/right Front Lower Bracket (all models)

For 2007-2018 Chevy/GMC Silverado/Sierra 1500 Crew Cab(Incl. 2019 Silverado 1500 LD & 2019 Sierra 1500 Limited)/
2007-2019 Chevy/GMC Silverado/Sierra 2500/3500 Crew Cab (Incl. Diesel Models With DEF Tanks)Not For 07 Classic Model

Passenger/right Side Installation Pictured

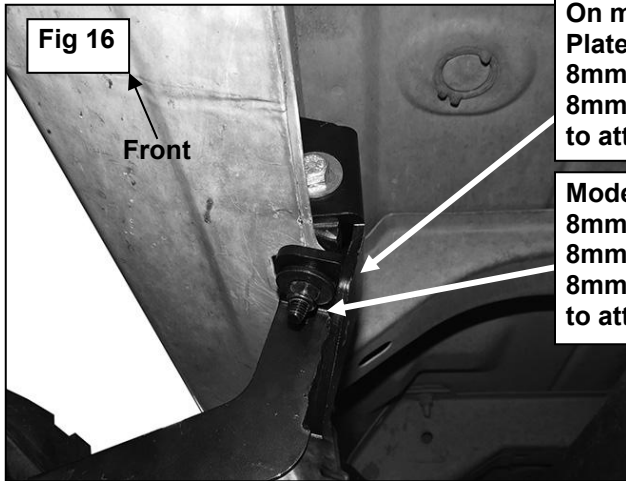

On models with flat tab and 8mm Bolt Plate (see Fig. 13) use:
8mm Flat Washer
8mm Nylon Lock Nut
to attach Lower Bracket to Bolt Plate

Models with weld nut on tab use:
8mm x 25mm Hex Bolt
8mm Lock Washer
8mm Flat Washer
to attach Lower Bracket to weld nut

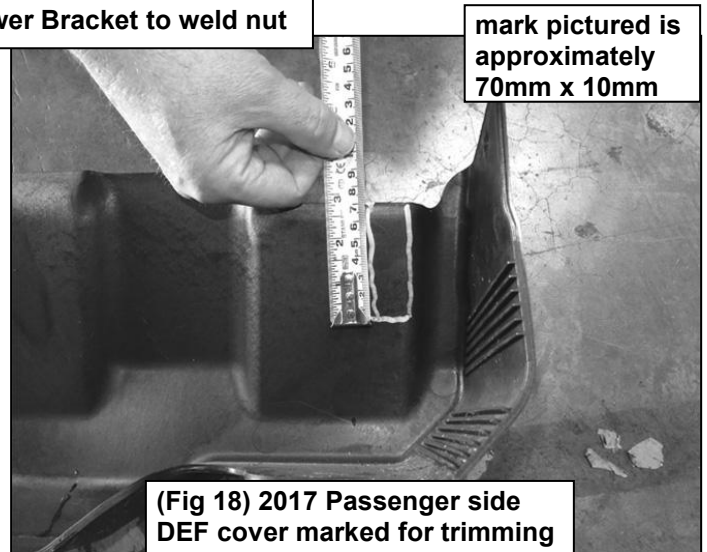

(Fig 18) 2017 Passenger side DEF cover marked for trimming

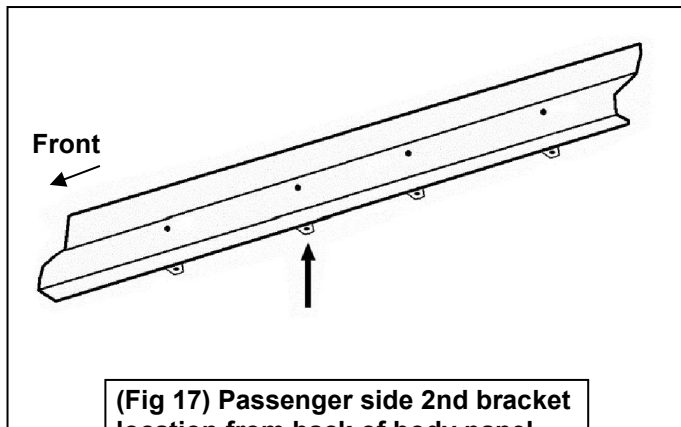

(Fig 17) Passenger side 2nd bracket location from back of body panel



(Fig 19) 2017 Passenger side DEF cut for example only

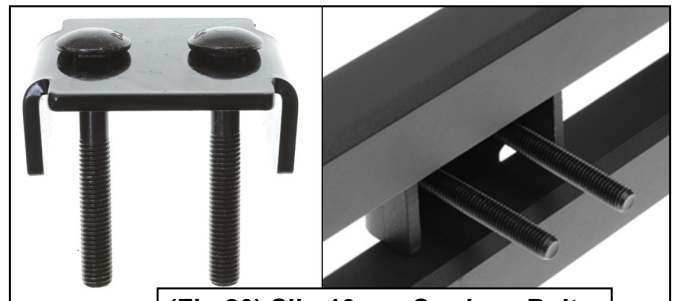

(Fig 20) Slip 10mm Carriage Bolts into the 2-Hole Support Bracket



Complete Installation

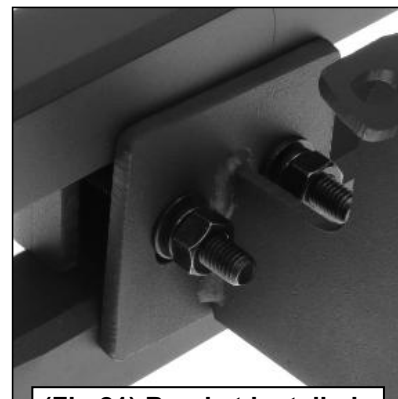

(Fig 21) Bracket installed

Discover other running boards and step bars on our website.