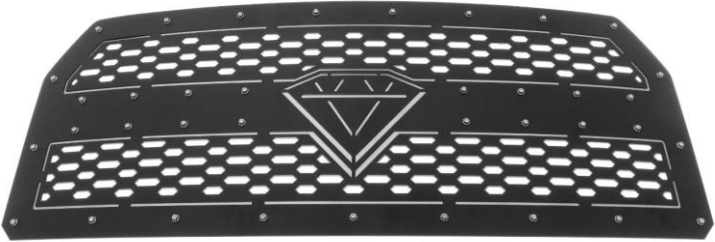

Grille Installation Instruction

Part#	GR06DFC10D	Application	For 2015-2017 Ford F-150 Main Upper					
-------	------------	-------------	--	--	--	--	--	--

Parts List	Item	Part Name	QTY	Description	Item	Part Name	QTY	Description
	1	Mesh Grille	1	Stainless steel	4	Fender Washers	7	
	2	"Z" Brackets (Long)	2		5	Nylon Lock Nuts	14	10-24
	3	"Z" Brackets (Short)	3					

Install Notes: Overlay Replacement Drill Cut

Step	Description	illustration
1	Identify the grille & hardware with parts list.	

2	Turn off engine and chalk tires with stop block . Open Hood.	
3	Identify & locate (10) plastic clips on top of plastic shroud and also (1) additional on each side located at the top of the headlight body panel cover. Carefully pry off to remove and then set aside for reinstallation later.	
4	Remove plastic shroud and then set aside for reinstallation later.	







On the inside of the inner wheel well lip, remove (2) 7mm bolts. The headlight plastic body panel should now loose. You will need to coax panel out and off catch tabs to remove completely. The plastic wedge spatula should help.

5		
---	---	--







The instruction here is for your reference only. You may need to bend the billet grille bars or tabs a little bit to adjust to fit. We strongly recommend the professional installer for best result. Please use masking tape and tape the OEM grille shell along the edge to protect your vehicle during installation. We are not responsible for any damage caused by the installation. Thank you for choosing our product!

Grille Installation Instruction

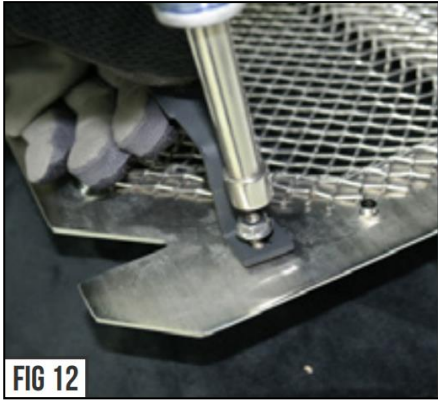
Part#	GR06DFC10D	Application	For 2015-2017 Ford F-150 Main Upper
6	<p>On each side of the factory grille near the bottom corner just outside and behind, there is (1) 8mm bolt, (1) 8mm bolt on each side. Use 8mm socket to remove the (2) bolts.</p>		 <p style="text-align: center;">FIG 6</p>
7	<p>On top of the core support, remove (4) 8mm bolts.</p>		 <p style="text-align: center;">FIG 7 FIG 8</p>
8	<p>Remove (4) plastic clips on upper corner near head lamp.</p>		
9	<p>Located next to the hood latch, disconnect (2) sensors located at the top center of grille. Note to pull the plastic cable support clip.</p>		 <p style="text-align: center;">FIG 9</p>
10	<p>The OEM Factory Grille should now be free and ready to remove. Carefully place the grille on a soft cushioned surface and prepare to remove the shutter component which is currently fastened to the backside of the factory grille.</p>		
11	<p>Remove the (7) 10mm plastic bolts that line the outside edge and the (1) 8mm bolt that is secures the center structure.</p>		
12	<p>Remove the (4) plastic clips located on the top lip.</p>		
13	<p>Set factory grille aside and prepare to install your new Grille.</p>		
 <p style="text-align: center;">FIG 10 FIG 11 FIG 12</p>			

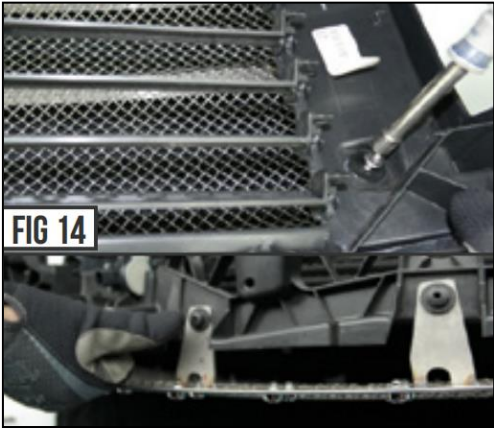
The instruction here is for your reference only. You may need to bend the billet grille bars or tabs a little bit to adjust to fit. We strongly recommend the professional installer for best result.
 Please use masking tape and tape the OEM grille shell along the edge to protect your vehicle during installation.
 We are not responsible for any damage caused by the installation. Thank you for choosing our product!

Grille Installation Instruction

Part#	GR06DFC10D	Application	For 2015-2017 Ford F-150 Main Upper
14	<p>With the new grille unit placed face down on a flat cushioned surface. Set all extension brackets in place starting with large bracket on the lower bottom corners and the small brackets in the middle. Secure and fasten them with 10mm nuts.</p>		
 <p data-bbox="415 758 500 800">FIG 12</p>		 <p data-bbox="850 758 935 800">FIG 13</p>	
15	<p>Reinstall shutter component to new grille with factory hardware that was previously removed.</p>	 <p data-bbox="915 1024 1000 1066">FIG 14</p>	
16	<p>Flip up and stand the entire grille unit up to access top. Re-insert plastic clips which will than secure shutter component to new grille.</p>		
17	<p>Grille assembly is now ready to reinstall on vehicle. Match it up to factory mounting points and reinstall in the reverse order that the grille was removed. Start with the (4) 10mm factory bolts on top and the (2) 8mm bolts located near the bottom corners.</p>		
 <p data-bbox="363 1745 448 1787">FIG 15</p>		 <p data-bbox="716 1745 800 1787">FIG 16</p>	 <p data-bbox="1013 1745 1097 1787">FIG 17</p>

The instruction here is for your reference only. You may need to bend the billet grille bars or tabs a little bit to adjust to fit. We strongly recommend the professional installer for best result. Please use masking tape and tape the OEM grille shell along the edge to protect your vehicle during installation. We are not responsible for any damage caused by the installation. Thank you for choosing our product!

Grille Installation Instruction

Part#	GR06DFC10D	Application	For 2015-2017 Ford F-150 Main Upper
18	Plug the (2) sensor connections back into the shutter component sensor units.		
19	Place plastic radiator shroud cover over core support making sure the cold air intake lip is overlapped on top of the shroud. Align the factory mounting holes and use the (10) plastic clips to secure and fasten in position		
20	Carefully put back into place the headlight plastic body panel around the head lamp area making sure to align with 8 tab fasteners and then firmly press into place. Use the (2) bolts to mount and secure the panel on the inside wheel well lip. on each side of the grille at the top corners, reinsert the plastic tabs. (1) on each side		
21	Reinstall the plastic shroud with the fasteners removed in Step 4.		
22	Installation completed!!!		

The instruction here is for your reference only. You may need to bend the billet grille bars or tabs a little bit to adjust to fit. We strongly recommend the professional installer for best result.
Please use masking tape and tape the OEM grille shell along the edge to protect your vehicle during installation.
We are not responsible for any damage caused by the installation. Thank you for choosing our product!