



Grille Installation Instruction

Part#	GR04GEE40 T/H	<i>Application</i>	For 2019-2020 Ram 1500 Laramie/Lone Star/Big Horn/Tradesman Main Upper
--------------	--------------------------	--------------------	---

Parts List	Item	Part Name	QTY	Description	Item	Part Name	QTY	Description
	1	Mesh Grille	1	Stainless steel	4	Top Plate	1	
	2	Flange Nuts	23	10#	5	Bottom Plate	1	
	3	"C" Brackets	8		6	Left&Right Bottom Plate	2	

Install Notes: Overlay Replacement Drill Cut

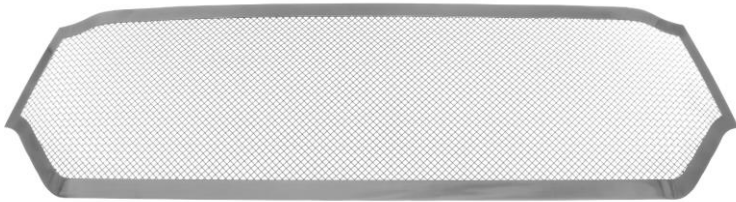
Step	Description	Illustration
1	Identify the grille & hardware with parts list. Attach (4) plates as shown(Fig 1)	
2	Turn off engine, chalk tires with stop block, open the hood and disconnect the battery. The OEM Factory Grille will have to be removed. Begin grille removal by prying free all the Push Pin Retainer Clips (x12) to remove the radiator cover. (Fig 2)	
3	With the Radiator Panel Cover removed, Identify and remove the (x18) screws that secure the top trim/grille frame. (Fig 3-6)	

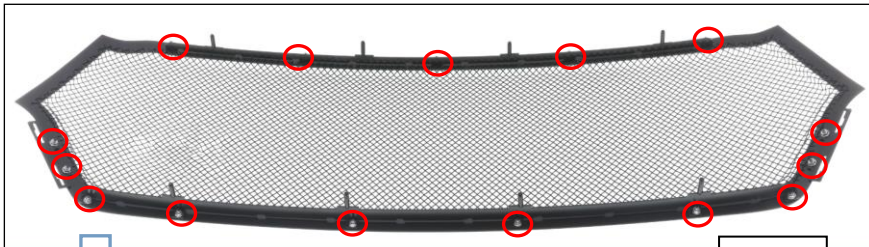
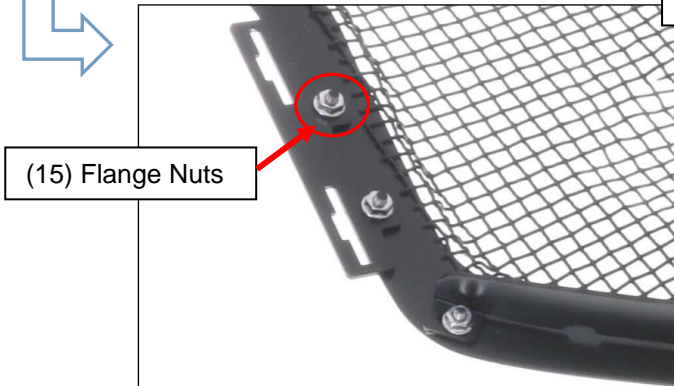

Fig 1



FIG 2



(15) Flange Nuts

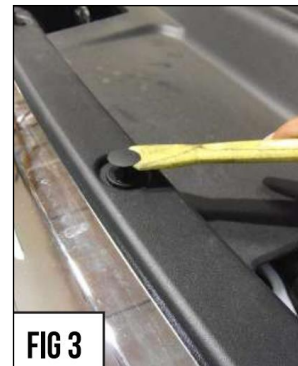

FIG 3

The instruction here is for your reference only. You may need to bend the grille a little bit to adjust to fit. We strongly recommend the professional installer for best result. We are not responsible for any damage caused by the installation. Thank you for choosing our product!

Grille Installation Instruction

Part#	GR04GEE40 T/H	Application	For 2019-2020 Ram 1500 Laramie/Lone Star/Big Horn/Tradesman Main Upper
4	Remove the (x4) screw from the front of the wheel well. Pull back the inner wheel well liner to access the front bumper / fender panel support mount. (Fig 7)		
5	Pull and remove the (front bumper / fender panel support mount) bolt as seen in Figures 8 & 9. (Fig 8-9)		
6	Repeat on opposite side.		
7	Separate the Vehicle's Front Bumper Fascia from the Front Fender. You may need to coax free by pulling the fascia panels pushing on the fender.(Fig 10-11)		
8	Remove the (x3) bolts as seen in Figure # 12. Repeat on opposite side. (Fig 12)		
9	The Vehicle's Factory Grille should now be free to remove. Set it face down on a soft padded surface Separate the OEM Grille Plastic Mounting Shroud by removing the screws as seen in Figure #13 (Fig 13-14)		
10	With the OEM Factory Grille fully disassembled, set aside, and take the OEM Grille Plastic Mounting Shroud and position over and onto new Replacement Grille. Secure in place with the provided "C" Bracket the 10-32 Nylon Nuts. The Replacement Grille should now be ready for installation. (Fig 15-16)		
11	Take the assembled grille component and put into place to install onto vehicle. (Fig 17)		

The instruction here is for your reference only. You may need to bend the grille a little bit to adjust to fit. We strongly recommend the professional installer for best result. We are not responsible for any damage caused by the installation. Thank you for choosing our product!

Grille Installation Instruction

Part#	GR04GEE40 T/H	Application	For 2019-2020 Ram 1500 Laramie/Lone Star/Big Horn/Tradesman Main Upper
-------	--------------------------	-------------	---

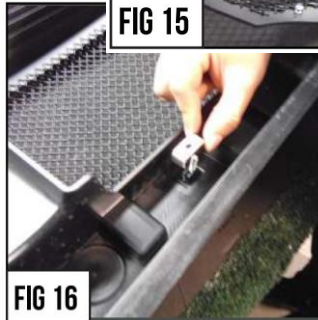
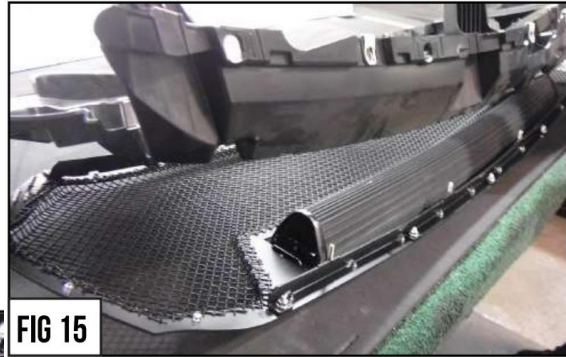
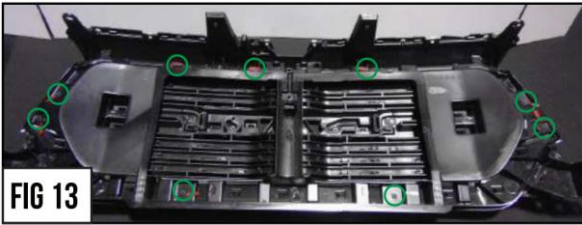

- 12 Secure the grille to vehicle by screwing the bolts that were removed in Step #8 Step #3. (Fig 18)
- 13 Re-Install the bumper fascia panels as seen in Figure #19. Attach the and secure the front fender to bumper fascia panel in the reverse order as they were removed. Re-Install the Vehicle's Factory Top Trim Piece. Re-Install the Vehicle's Radiator Cover Panel. (Fig 19-22)

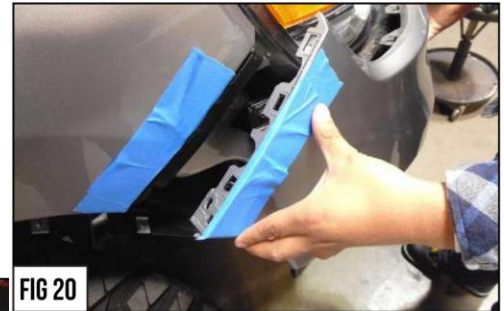

14	Installation completed!!!	
----	---------------------------	--

The instruction here is for your reference only. You may need to bend the grille a little bit to adjust to fit. We strongly recommend the professional installer for best result. We are not responsible for any damage caused by the installation. Thank you for choosing our product!