

# Service Parts Catalog **AP** Products







**AP** Products

**AP Products** was established in 1994 by Tom Manning Sr. The original intent was to assist one of the suppliers Tom Manning & Associates represented by offering a complimenting line of packaged screws. From there, the company has added a host of products as opportunities arose.

All of the products being offered speak to a specific need in the market place that is not being met. This particular Service Parts catalog is intended to assist RV Dealers in the process of identifying critical service parts needed to repair and maintain their customer's RVs.

We believe the health of the industry is

dependent upon a strong Dealer base that is able to fulfill every customer's expectation in a timely and profitable manner. It is our desire to make use of our resources and talents to assist in that process.

Our entire team believes the best means for doing this is for service parts to be stocked in the field by Wholesale Distributors to make them readily available to the dealer when needed.

All of these parts are available from your preferred distributor. If you need additional assistance, we would be pleased to assist.

**AP Products Service Parts Catalog**





# **AP** Products

<b>Bits .....</b>	<b>24-25</b>
<b>Entrance Doors/Replacement Parts .....</b>	<b>12</b>
<b>LITECO Products .....</b>	<b>14-15</b>
<b>Mouldings - Aluminum &amp; Polymer .....</b>	<b>31-32</b>
<b>RV Adapters &amp; Extension Cords .....</b>	<b>33-36</b>
<b>Screws .....</b>	<b>27-30</b>
<b>Screw Covers / Trim .....</b>	<b>10-11</b>
<b>SIKA® Silicon Products .....</b>	<b>18-19</b>
<b>Slide Out Parts.....</b>	<b>2-5</b>
<b>Sockets / Nutsetters .....</b>	<b>26</b>
<b>Spray Paint .....</b>	<b>21</b>
<b>STA-PUT Spray Adhesives .....</b>	<b>20</b>
<b>Surface Shields® .....</b>	<b>16-17</b>
<b>Tools .....</b>	<b>22-23</b>
<b>Weather Seals / Trim .....</b>	<b>6-9</b>

**Slide Out Parts**

**014-132682 - 18:1 Venture Actuator Motor**  
(2-1/4" inner gear)

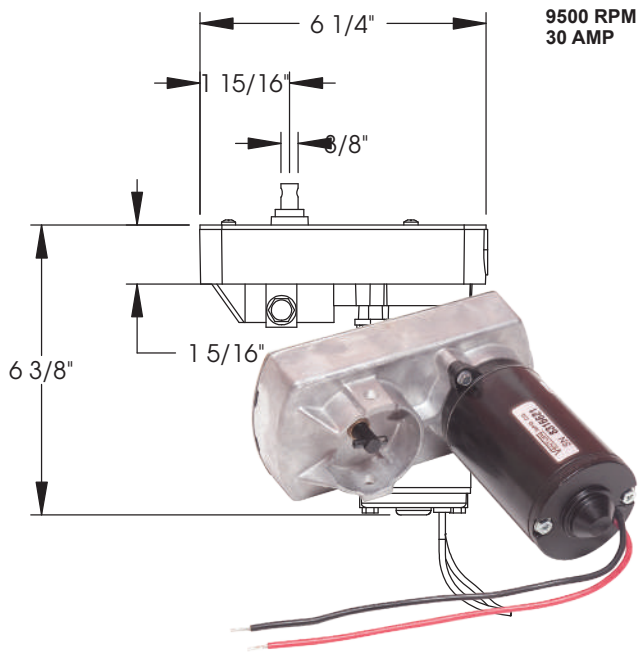

**014-136373 - 28:1 Venture Actuator Motor**  
(2-1/2" inner gear)

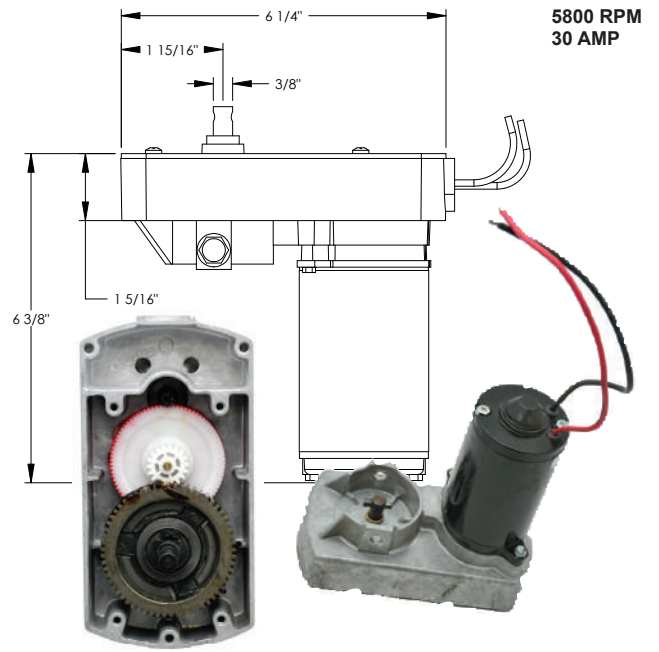

**014-125802 - 9000 RPM 18:1 Motor (Tuscon)**  
(When not avail. sub. with 014-168956)

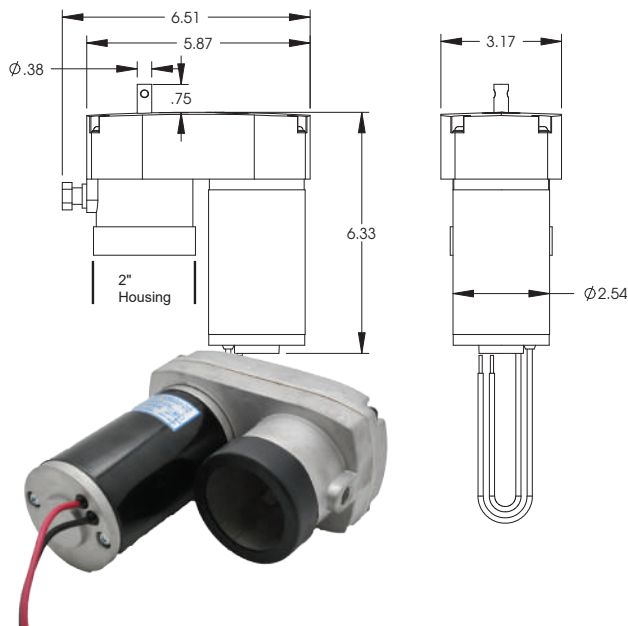

**014-133612 - 18:1 Tuscon Motor/Driveshaft**  
(With right angle gear box)

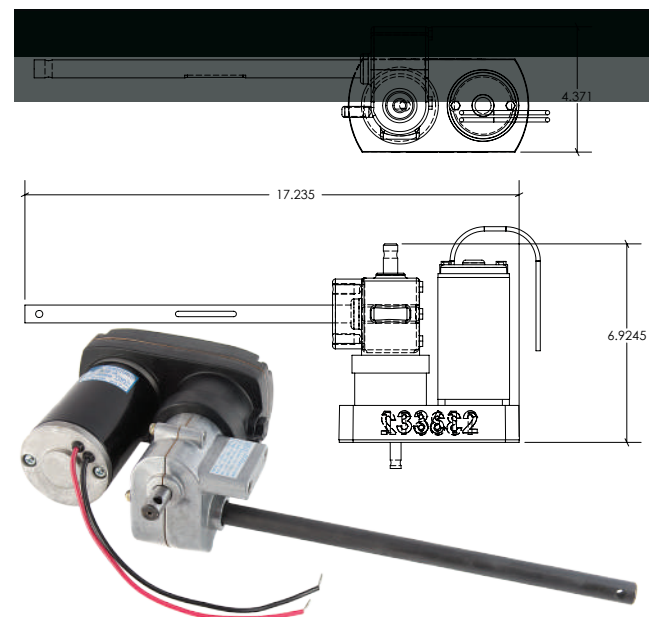

**Slide Out Parts**

**014-122837 - Standard Gear Pack - nickel**  
(Without roll pin assy.)

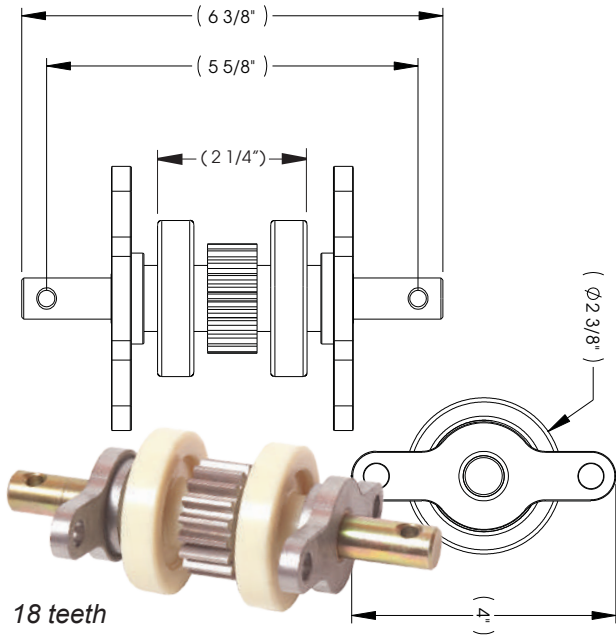

**014-324869 - Standard Gear Pack - nickel**  
(Without roll pin assy.)

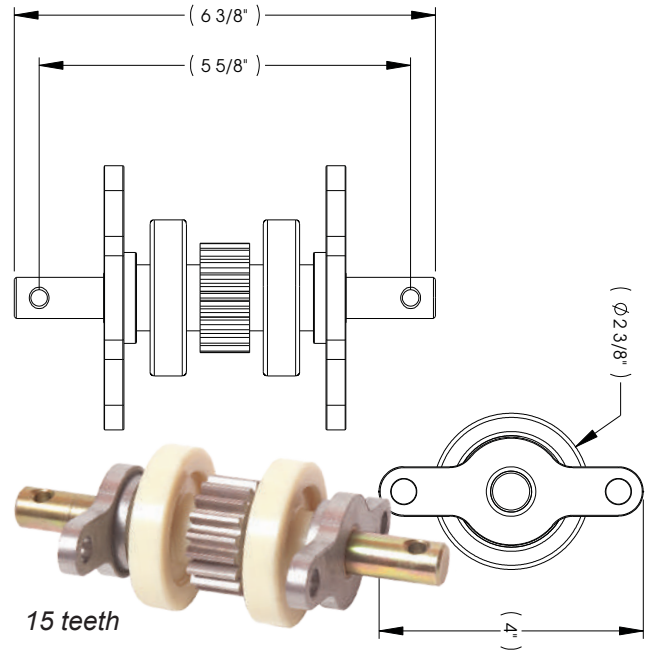

**014-140409 - Gear Pack 2x3**  
(With roll pin assy.)

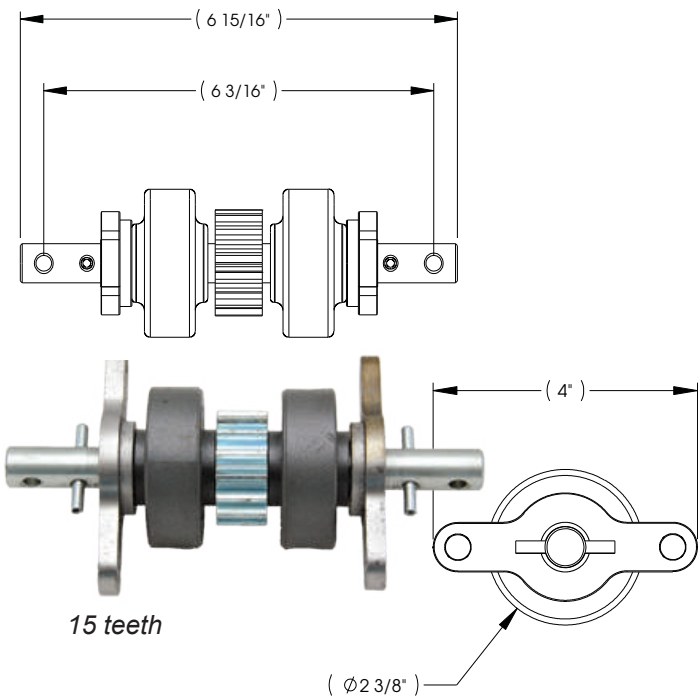

**014-281331 - 2x2 Gear Pack**  
(Without roll pin assy.)

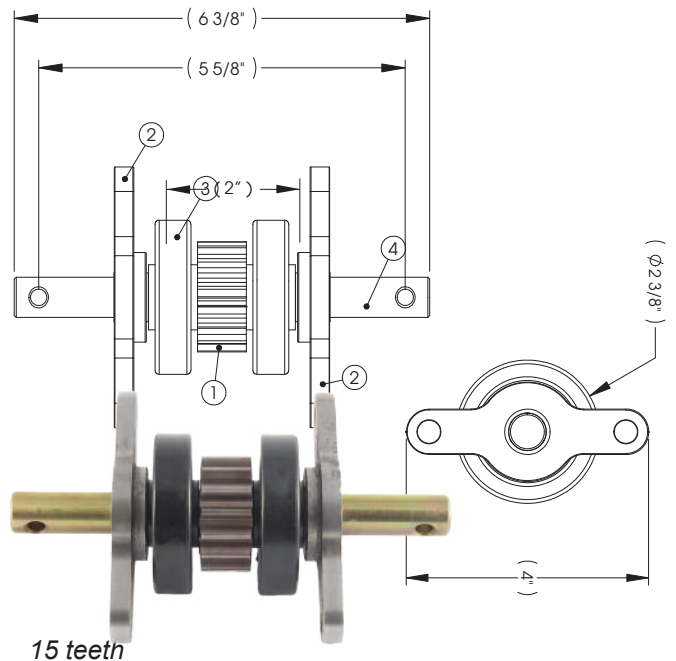



**Slide Out Parts**

**014-136046 - Trombetta Polar Reverse Solenoid**



**014-118246 - Trombetta Solenoid for Leveling**



**014-191072 - 18:1 Venture Gear Set**

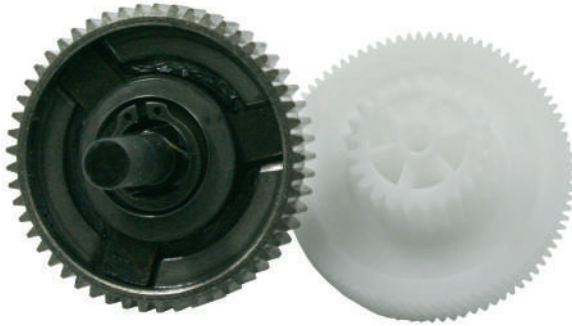

**014-119226 - Standard S/O Crank Handles**

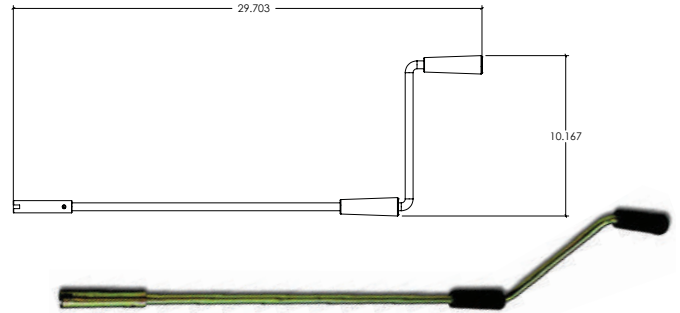

**014-145595 - Venture Actuator**

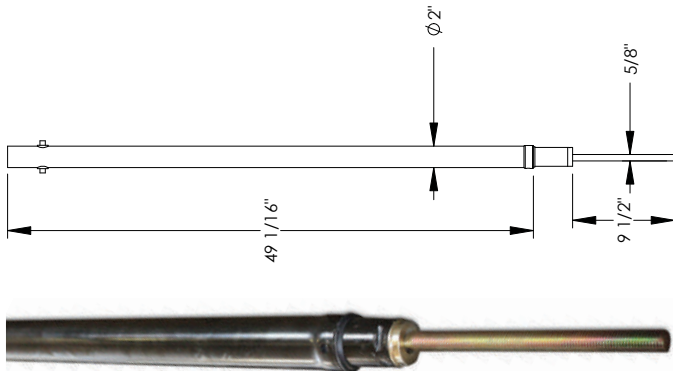

**014-131903 - 40" Tucson Actuator - 18:1 Motor**

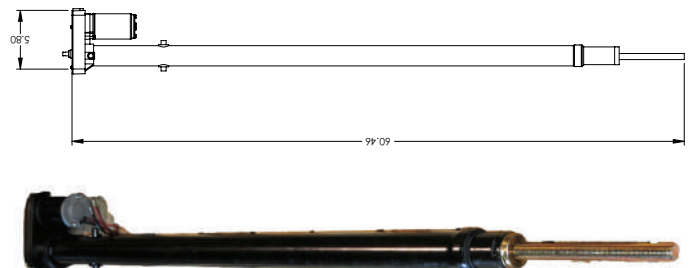

**Slide Out Parts**

**014-119129 - 40" Venture Actuator - 18:1 Motor**

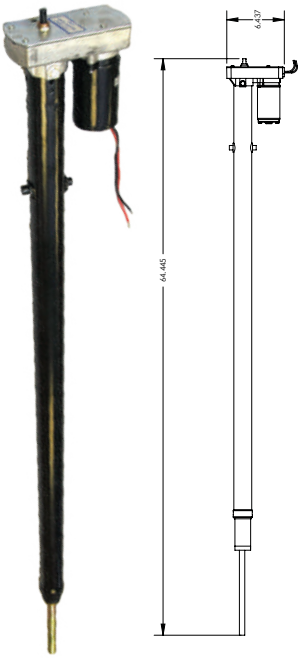

**014-168956 - 40" Venture Actuator - High Speed Motor**

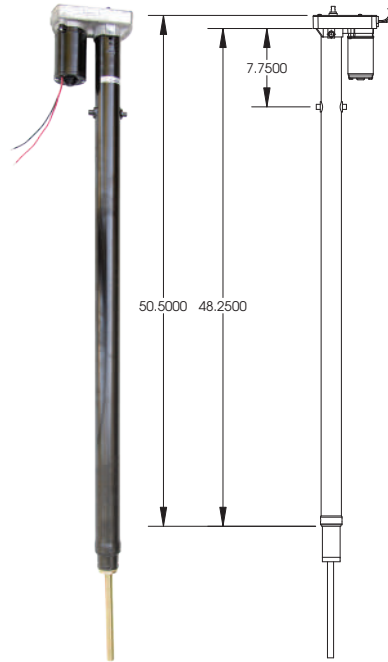

## Slide Out Seals

### EK Seal Base w/Wiper

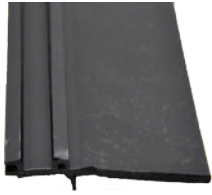

**018-314-BLK**  
EK Base w/1-3/4" wiper  
1/2" x 2-1/2" x 35'  
Black w/Hats Tape

**018-341**  
EK Base w/2" wiper  
1/2" x 2-3/4" x 35'  
Black w/Hats Tape

**018-316**  
EK Base w/2-7/8" wiper  
1/2" x 3-2/3" x 35'  
Black w/Hats Tape



**018-384**  
EK Base w/1-1/4" wiper  
1/2" x 2" x 35'  
White w/Hats Tape

**018-426**  
EK Base w/2" wiper  
1/2" x 2-3/4" x 35'  
White w/Hats Tape

**018-317**  
EK Base w/2-7/8" wiper  
1/2" x 3-2/3" x 35'  
White w/Hats Tape

### Rubber Slide out Seal w/Wiper



**018-314**  
5/8" x 1-15/16" x 35'  
White w/Hats Tape



**018-2080-168**  
Double EKD Base w/2-3/8" wiper  
1-1/2" x 3-3/16" x 14'  
Black

**018-2030-168**  
Double EKD Base w/2-3/8" wiper  
2" x 3-3/16" x 14'  
Black

**018-2082-168**  
Double EKD Base w/2-3/4" wiper  
1-1/2" x 3-1/2" x 14'  
Black



**018-2062-153**  
Double EKD Base  
1-1/4" x 1-3/4" x 12-3/4'  
Black w/Hats Tape

**018-2062-96**  
Double EKD Base  
1-1/4" x 1-3/4" x 8'  
Black w/Hats Tape



**018-1723**  
EK BASE w/1-1/4" wiper  
1/4" x 2" x 35'  
Black w/Hats Tape



**018-188**  
EK "L" Wiper  
2-1/2" x 4/5" x 20'  
Black w/Hats Tape

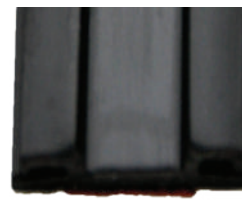

**018-2033**  
EK Channel  
7/8" x 1/4" x 50'  
Black w/Hats Tape

### Slide Out Seals



**NEW PRODUCT!**

**018-1291**  
Small KE Outer Seal  
2-1/2" x 1-3/32" x 30'  
Black



**NEW PRODUCT!**

**018-1656-200**  
Double KE Base w/1-4/5" wiper  
1-3/4" x 2-11/16" x 16-3/4'  
Black w/Hats Tape



**NEW PRODUCT!**

**018-1676**  
Bottom Pan w/4" wiper  
2-15/64" x 4-1/64" x 15' 10"  
Black



**NEW PRODUCT!**

**018-1718**  
KE Base w/1-1/4" wiper  
5/16" x 2-1/32" x 30'  
Black w/Hats Tape



**NEW PRODUCT!**

**018-1884-168**  
Single KE Cap w/2-4/5" wiper  
3-11/16" x 1-1/4" x 14'  
Black w/Hats Tape



**NEW PRODUCT!**

**018-1886-192**  
Seal KE Base w/2-26/32" wiper  
3-11/16" x 1-1/4" x 16'  
Black w/Hats Tape



**NEW PRODUCT!**

**018-3157-168**  
Roller Bar  
2" x 1" x 14'  
Black w/Hats Tape



**NEW PRODUCT!**

**018-3203**  
Bulb Seal w/2-1/8" wiper  
3-9/64" x 2-1/2" x 30'  
Black w/Hats Tape



**NEW PRODUCT!**

**018-3231**  
Single EK Flap w/2" wiper  
2-25/32" x 1-3/16" x 30'  
Black w/Hats Tape



**EK D Seal To Be Used with Base**



**018-312-EKD**  
D Seal for EKD Base  
1" x 15/16" x 35'  
Black



**018-184-EKD**  
D Seal for EKD Base  
1" x 15/16" x 35'  
White



**018-522**  
D Seal for EKD Base w/Fins  
1-1/2" x 1" x 40'  
Black



**018-1065-EKD**  
D Seal for EKD Base  
1" x 15/16" x 35'  
Grey

**018-350-EKD**  
D Seal for EKD Base  
1" x 15/16" x 50'  
Black



**018-1069-EKD**  
D Seal w/Off Set Bulb  
1-1/16" x 1/4" x 50'  
White



**018-2004**  
Modified EKD Seal  
1" x 1" x 50'  
Black



**018-1681**  
Small EK Outer Seal  
9/10" x 11/16" x 100'  
Black

**Other SlideOut Seals**



**018-478**  
Double Bulb w/1-1/2" Wiper  
2" x 2-1/4" x 28'  
Black

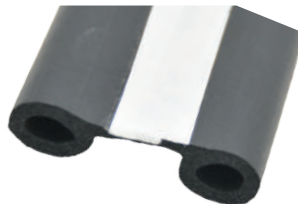

**018-564**  
EPDM DBL Bulb Seal w/ Tape  
1-1/2" x 1/2" x 50'  
Black



**018-607**  
P Seal w/Tape  
2-1/2" x 7/8" x 100'  
Black



**018-338- BLK**  
Slide in Secondary Seal  
13/16" x 11/16" x 30'  
Black



**018-1138**  
Single Bulb w/Wiper  
1-1/8" x 2-1/8" x 35'  
Black



**018-1470-84**  
1.375" EK Cap w/1.5" Wall Jamb  
4-3/8" x 2-5/8" x 7'  
Black



**018-546**  
Clip On Wiper with 2" Wiper  
7/16" x 3" x 35'  
Black



**018-668**  
Snap-In Seal with 2-7/8" Wiper  
4-1/8" x 23/32" x 35'  
Black

## Seals for Doors, Windows and more

### Non Ribbed D Seal w/Tape



**018-224**  
Non-Ribbed D Seal  
1/2" x 3/8" x 50'  
Black w/PSA (White Tape)



**018-204**  
Non-Ribbed D Seal  
1/2" x 3/8" x 50'  
White w/PSA (White Tape)



**018-318**  
Non-Ribbed D Seal  
3/4" x 1/2" x 50'  
Black w/PSA (White Tape)



**018-663**  
Non-Ribbed D Seal  
3/4" x 3/4" x 50'  
Black w/Hats Tape

### Bulb Seal with Slide on Clip



**018-088-BB**  
Single Bulb  
1" x 3/4" x 28'  
Black



**018-742**  
Single Bulb  
1" x 3/4" x 28'  
White



**018-181-BB**  
Slide Double Bulb  
1-1/2" x 3/4" x 28'  
Black



**018-1509**  
Single Bulb  
3/4" x 7/16" x 28'  
Black

### Ribbed D Seal w/Tape



**018-023-PT**  
Foam D Seal  
1" x 1" x 50'  
w/PSA (White Tape)  
Black

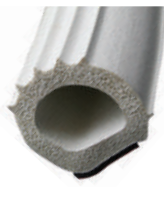

**018-1097**  
Foam D Seal  
1" x 1" x 50'  
White w/Hats Tape



**018-206**  
Foam D Seal  
1" x 1" x 50'  
Black w/Hats Tape



**018-1894**  
J Bulb  
1" x 3/4" x 28'  
Black



**018-3009**  
Single Bulb  
15/16" x 1-1/2" x 43'  
Black

### Foam Seal w/Tape



**018-523**  
5/8" x 3/8" x 50'  
Black w/PSA (White Tape)

**018-855**  
1/2" x 5/16" x 50'  
Black w/Rib w/PSA (White Tape)



**018-664**  
Ribbed Seal  
3/16" x 3/8" x 50'  
Black w/PSA (White Tape)

**018-821125**  
Low Density NEO/EPDM  
1" x 1-1/4" x 25'

### Vinyl Insert for Trim Molding

- 3/4" x 25' Insert**
- 011-315 Tan
  - 011-316 White
  - 011-317 Black
  - 011-318 Colonial White
- 3/4" x 100' Insert**
- 011-320 White
  - 011-321 Black
  - 011-322 Colonial White
  - 011-334 Walnut
  - 011-340 Dark Gray
- 3/4" x 1800' Insert**
- 011-393 White
  - 011-394 Black

- 1" x 25' Insert**
- 011-301 White
  - 011-302 Black
- 1" x 50' Insert**
- 011-329 White
  - 011-330 Black
  - 011-331 Colonial White
- 1" x 1000' Insert**
- 011-311 White
  - 011-312 Black
  - 011-313 Colonial White
  - 011-338 Dark Gray





# Seals for Doors, Windows and more

## Schwintek Bottom & Corners

Slide Out Seals to be used when either repairing or installing new Schwintek Slide. Bottom panels may be cut to desired length.

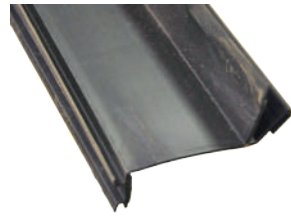

**018-1932-168**  
Bottom Pan Seal w/1-1/4" Wiper  
2" x 3" x 14'  
Black

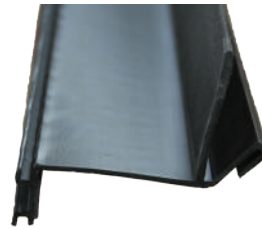

**018-1933-168**  
Bottom Pan Seal w/1-3/4" Wiper  
2-1/4" x 3" x 14'  
Black



**018-1923-156**  
EK Pan Base w/1-5/8" Wiper  
1-1/3" x 1-5/8" x 13'  
Black



**018-1161-RH**  
Corner-Block RH  
Notched  
4-1/2" x 2-1/2" x 2"  
Black



**018-1161-LH**  
Corner-Block LH  
Notched  
4-1/2" x 2-1/2" x 2"  
Black



**018-1998-RH**  
Corner-Block RH  
Notched  
4-1/2" x 2-1/2" x 3"  
Black



**018-1998-LH**  
Corner-Block LH  
Notched  
4-1/2" x 2-1/2" x 3"  
Black

## Trim Seal

**018-3006**  
Clip On Trim Seal *Black*  
**018-667**  
Clip On Trim Seal *White*  
OD 9/16" x 1/4" x 50'  
ID 1/3" x 5/64" x 50'



## Sewn In Clip

**018-635-96**  
Poly Sewn In Clip (2 pack)  
*White*  
1-3/16" x 3/8" x 8'  
**018-635-216**  
Poly Sewn In Clip  
*White*  
1-3/16" x 3/8" x 18'



## Weather Stripping

Quality Cap Tape and Weather Stripping products for use around windows, doors or any place where you are looking to quiet or prevent moisture, dirt and dust from entering. All products are individually packaged.



### Thickness x Width x Length

<b>018-181417</b>	1/8" x 1/4" x 50'
<b>018-3163810</b>	3/16" x 3/8" x 10'
<b>018-3163817</b>	3/16" x 3/8" x 50'
<b>018-3161210</b>	3/16" x 1/2" x 10'
<b>018-3163410</b>	3/16" x 3/4" x 10'
<b>018-143817</b>	1/4" x 3/8" x 50'
<b>018-5163810</b>	5/16" x 3/8" x 10'
<b>018-5163410</b>	5/16" x 3/4" x 10'
<b>018-516110</b>	5/16" x 1" x 10'
<b>018-381210</b>	3/8" x 1/2" x 50'
<b>018-383410</b>	3/8" x 3/4" x 50'
<b>018-5161250</b>	5/16" x 1/2" x 50'
<b>018-516150</b>	5/16" x 1" x 50'
<b>018-5163450</b>	5/16" x 3/4" x 50'
<b>018-5321250</b>	5/32" x 1/2" x 50'
<b>018-532150</b>	5/32" x 1" x 50'
<b>018-5323450</b>	5/32" x 3/4" x 50'
<b>018-5323850</b>	5/32" x 3/8" x 50'
<b>018-5325850</b>	5/32" x 5/8" x 50'

## Cap Tape

Grey Mylar backed PVC Foam Tape w/adhesive coating. Great for Truck Caps and other areas where a good seal against weather and dust is desired. Also great for quieting rattles and squeaks. Comes in Poly Bag and is available in a variety of widths.

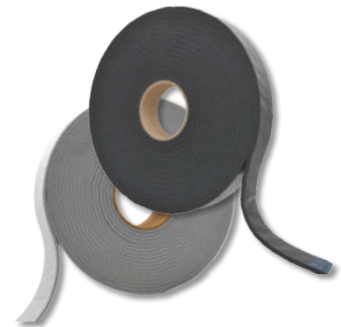

<b>018-316130</b>	3/16" x 1" x 30'	Grey
<b>018-3161530</b>	3/16" x 1-1/2" x 30'	Grey
<b>018-3162530</b>	3/16" x 2-1/2" x 30'	Grey
<b>018-141125</b>	1/4" x 1-1/2" x 30'	Grey
<b>018-1400125 B</b>	1/4" x 1-1/2" x 30'	Black
<b>018-381530</b>	3/8" x 1-1/2" x 30'	Grey

## Screw Covers / Trim

### Flexible Plastic Insert Trim - 5/8"

Quality plastic insert for use on doors, trim molding and windows. Available in 1000 foot spools or handy 25 foot packages.

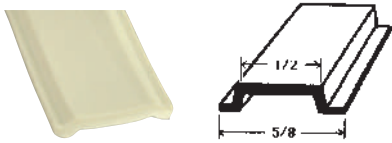

Part #	Description	Color
011-387	1000' Insert	Polar White
011-388	1000' Insert	Brown
011-389	1000' Insert	Black
011-390	1000' Insert	Colonial White
011-391	1000' Insert	Beige
011-348	100' Insert	Polar White
011-345	100' Insert	Brown
011-347	100' Insert	Black
011-401	50' Insert	Polar White
011-403	50' Insert	Black
011-370	25' Insert	Polar White
011-366	25' Insert	Brown
011-367	25' Insert	Black
011-368	25' Insert	Colonial White
011-369	25' Insert	Beige

### Quality Plastic Insert Trim - 7/8"

Quality plastic insert for use on doors, trim molding and windows. Available in 750 foot spools or handy 25 foot packages.

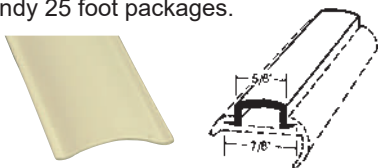

Part #	Description	Color
011-382	750' Insert	Polar White
011-383	750' Insert	Brown
011-384	750' Insert	Black
011-385	750' Insert	Colonial White
011-386	750' Insert	Beige
011-374	100' Insert	Black
011-371	100' Insert	Beige
011-376	50' Insert	Polar White
011-378	50' Insert	Black
011-349	25' Insert	Polar White
011-350	25' Insert	Brown
011-351	25' Insert	Black
011-352	25' Insert	Colonial White

### Elixir Screw Cover

Part #	Description	Color
011-354	8' Screw Cover	Colonial White
011-355	8' Screw Cover	Black
011-356	8' Screw Cover	Brown
011-357	8' Screw Cover	Polar White

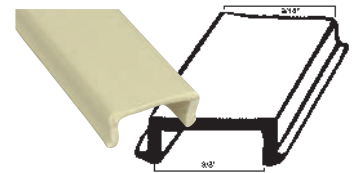

### Philips Screw Cover

Part #	Description	Color
011-358	8' Screw Cover	Colonial White
011-359	8' Screw Cover	Black
011-360	8' Screw Cover	Brown
011-361	8' Screw Cover	Polar White

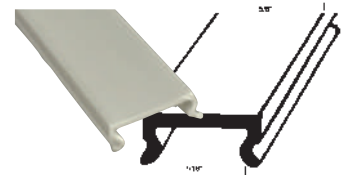

### Hehr Screw Cover

Part #	Description	Color
011-362	8' Screw Cover	Colonial White
011-363	8' Screw Cover	Black
011-364	8' Screw Cover	Brown
011-365	8' Screw Cover	Polar White

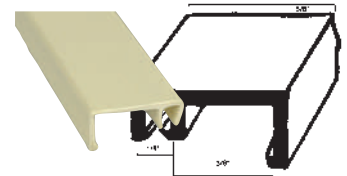

### Flexible PVC Screw Cover - 5/8"

Part #	Description	Color
011-103	600'	White

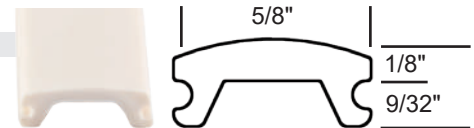

### Flexible Screw Cover - 7/8"

Part #	Description	Color
011-407	50' Screw Cover	Polar White
011-408	50' Screw Cover	Black
011-409	500' Screw Cover	Polar White
011-410	500' Screw Cover	Black



### Flexible Screw Cover - 3/4"

Part #	Description	Color
011-398	50' Insert	Polar White
011-399	50' Insert	Black
011-400	500' Insert	Polar White

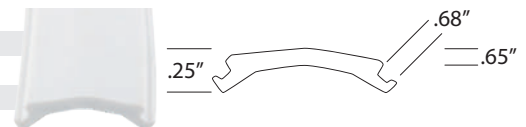

### Insert Molding Trim - 3/4"

Part #	Description	Color
011-444	200'	Polar White

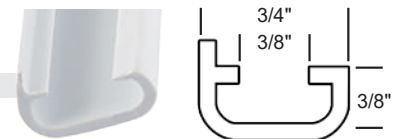

### Vinyl Gimp Trailer Welt

Part #	Description	Color
011-381	750' Spool	Light Brown
011-397	750' Spool	White





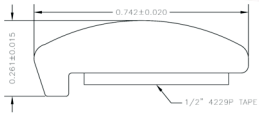

**Trim**

Part #	Description	Color
011-1730	30' L-Trim w/tape	Silver

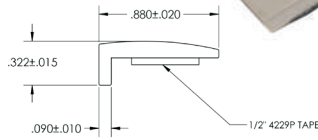

**Trim**

Part #	Description	Color
011-2196	30' L-5 Trim w/tape	Platinum

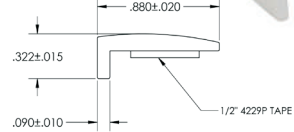
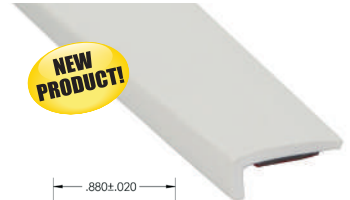

**Trim**

Part #	Description	Color
011-3076	30' L-Trim w/tape	Glacier White

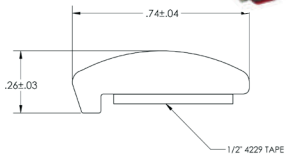

**Trim**

Part #	Description	Color
011-3077	30' L-Trim w/tape	Napa Beige

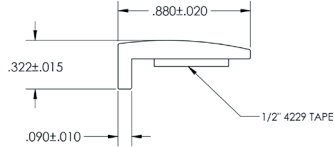

**Trim**

Part #	Description	Color
011-3078	30' L-5 Trim	Napa Beige

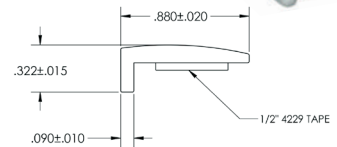

**Trim**

Part #	Description	Color
011-3117	30' L-Trim w/tape	Driftwood

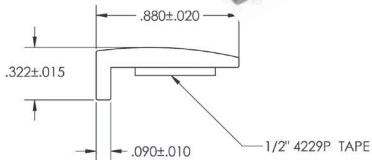

**Trim**

Part #	Description	Color
011-3118	30' L-5 Trim w/tape	Driftwood

## RV Entrance Doors

### RV Replacement Doors

- Available in Radius and Square profiles
- Available in Polar White (PW) only
- Measurements below are rough opening
- Includes screen doors; matching frame extrusion color; clear slide panels
- PW doors - have pebble interior and smooth exterior
- "RH" indicates right side hinges
- 2-1/4" frame thickness for towable and motorized doors
- 4" radius door corners



Custom size doors available, please call for quote.

### Door Replacement Trim

015-661 Screw Cover - 85" Rigid Plastic – Polar White

015-662 Door Screwcover - 85" - Off White

015-663 Door Screwcover - 85" - Black

015-2028911 Door Threshold - 92" - Mill Finish

### Misc Door Replacement Parts

015-201471 Screen Latch Right

015-201472 Screen Latch Left

015-198295 Hinge Assembly 6 Leaf – White

### Window Replacement Parts

015-2014742 Window Frame Inner & Outer w/Seal No Glass – White

015-2014762 Window Frame Inner & Outer w/Seal No Glass – Black

015-201495 Window Glass – Obscure 12-1/2" x 21-1/2"

015-201496 Window Glass – Tinted 12-1/2" x 21-1/2"

### Towable Entry Door

- Radius profile
- 12" x 21" window
- Flush lock with deadbolt

015-217708 24" x 68" Radius Entrance Door RH

015-206319 24" x 72" Radius Entrance Door RH

015-217709 26" x 72" Radius Entrance Door RH

015-217710 28" x 72" Radius Entrance Door RH

015-205998 30" x 72" Radius Entrance Door RH

### Towable Entry Door

- Square profile
- 12" x 21" window
- Flush lock with deadbolt

015-217711 24" x 68" Square Entrance Door RH

015-217712 24" x 70" Square Entrance Door RH

015-217713 24" x 72" Square Entrance Door RH

015-217714 24" x 76" Square Entrance Door RH

015-217715 26" x 68" Square Entrance Door RH

015-217716 26" x 70" Square Entrance Door RH

015-217717 26" x 72" Square Entrance Door RH

015-217718 26" x 78" Square Entrance Door RH

015-217719 28" x 72" Square Entrance Door RH

015-217720 30" x 72" Square Entrance Door RH

015-217721 32" x 72" Square Entrance Door RH

### Motorized Entry Door

- Radius profile
- 12" x 21" window with obscure glass, black frame
- Tri-mark lock with deadbolt

015-247031 24" x 70" Radius Entrance Door RH

015-247231 24" x 72" Radius Entrance Door RH

015-267231 26" x 72" Radius Entrance Door RH

### Thin Shade™ More info. on pg. 9 in Hardware Catalog

015-201512 Thin Shade™ Complete Unit

015-2014782 Thin Shade™ Window Frame Only - Black

015-201502 Thin Shade™ Replacement Shade Only - Black

015-201473 Frame Snap release tool







**LITECO Products**

**Europa Blk. w/Chrome Globe**

Part No.  
**005-06001059**

Quantity  
20/ctn



**Courtesy Light**

Part No.  
**005-068WMT**

Quantity  
50/ctn



**Dome Light**

Part No.  
**005-193**

Quantity  
40/ctn



**AC Unitek Double R/V**

Part No.  
**005-826L**

Quantity  
48/ctn



**Courtesy Light No Mount**

Part No.  
**005-068NM**

Quantity  
50/ctn



**AC Autotek Double Blk-2 Way V**

Part No.  
**005-726-02-2**

Quantity  
100/ctn



**Autotek Aircraft Light Black**

Part No.  
**005-725-02-2**

Quantity  
1/ctn



**Replacement Straight Handle**

Overall Length 12" : Width 1"

Part No.  
**005-E5300-D**

Quantity: Bulk



**Lighted Assist Handle - Overall Length - 21"**

Top screw to bottom screw - 18-7/8"  
Handle - 11-1/2"  
Brackets: Sm. - 4"; Lg. - 8-1/4"  
Between screw holes: Sm. - 3-1/2"  
Lg. - 6-3/8"

Part No.  
**005-5500-L**

Quantity  
1/ctn



**Europa Sng Blk w/Blk Globe**

Part No.  
**005-06001048**

Quantity  
20/ctn



**Replacement Curved Handle**

Overall Length 11-1/2" : Width 1"

Part No.  
**005-E5000-D**

Quantity: Bulk



**Lighted Assist Handle - Straight**

Overall length 17-1/2"  
Top screw to bottom screw - 16-1/2"  
Handle - 12"  
Bracket - 4"  
Between screw holes - 3-1/2"

Part No.  
**005-5300-L**

Quantity  
1/ctn



**LITECO Products**

**Stargazer Dbl. w/168 Bulb**

Part No.  
**005-06002001**

Quantity  
48/ctn



**Co-Pilot w/18" Flexible Shaft**

Part No.  
**005-03001150**

Quantity  
20/ctn



**Bulb Hlgn. 12V 10W (1651-H)**

Part No.  
**005-30655010**

Quantity  
10/ctn



**2-Bulb Slimline Incandescent Light with Dual Switch**

Part No.  
**005-18543936**

Quantity  
1/ctn



**Europa Dbl. Blk w/Blk Globes**

6" x 2-7/8" x 2-1/4"

Part No.  
**005-06001037**

Quantity  
20/ctn



**White Oval Courtesy Light**

Part No.  
**005-24077-64**

Quantity  
1/ctn





## Surface Shields®



### Carpent Shield® Self-adhesive Film

- Carpet Shield is a clear, self-adhering protective film for carpeting and flooring
- Non-slip surface is a special blend of polyethylene which is highly resistant to tears or punctures
- This product is ideal during remodeling, painting and moving
- Available in a variety of sizes.

022-CS2130W	21" x 30' Counter/Shelf Display – 12 Pack
022-CS18200	18" x 200' Reverse Wound
022-CS18600	18" x 600' Reverse Wound
022-CS181000	18" x 1000' Reverse Wound
022-CS21200	21" x 200' Reverse Wound
022-CS211000	21" x 1000' Reverse Wound
022-CS24200L	24" x 200' Reverse Wound
022-CS241000	24" x 1000' Reverse Wound
022-CSS211000RV	21" x 1000' RV Carpet Shield, reverse wound



### Double Polish Protection Film

- Designed to provide long-term carpet protection for RV's and manufactured homes.
- Double Polish is a clear 8 mil PVC film that is both strong and durable



022-DPC35150 35" x 150' Clear Film

### Multi Surface Protection Film

- Multi Surface Protection Film is a durable, self-adhering film for use on hard surfaces
- Adheres to tile, marble, granite, vinyl, laminates and hardwood surfaces
- Great for floor protection, countertops, tubs, sinks, doors and more.

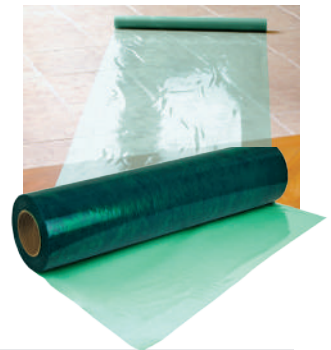

022-FS24200L	24" x 200' Reverse Wound	Green
022-FS24500	24" x 500' Reverse Wound	Green

### Step N Peel™

- Step N Peel™ Clean Mats are designed to remove dust and dirt from footwear
- Made of polyethylene film with a tacky surface that collects and holds dirt so you don't track it through your RV
- This sturdy product is reusable and features a nonskid backing that holds it securely to carpeting, tile, and more.
- 30 sheets per pad



022-DG30W	25.5"x31.5" Clear on White Frame - 30 Layer
022-DGRM	24"x30" Clear Refill Pad - 30 Layer

## Shoe Covers Dirt and Scuff Protection

- Surface Shields protect RV flooring and interior surfaces
- Available in three different materials - cloth, plastic and polyethylene
- Plastic shoe covers are great for outside use and the cloth is perfect to protect interior floors from dirt, scuffs and skids
- Skid resistant and waterproof



<b>022-SC3001PB</b>	Cloth Covers - 10 Pair Retail Pk.	Blue
<b>022-SC300</b>	Cloth Covers - 100 Pair Bulk Pk.	Blue

## Scrim Shield™

- Bottom board repair tape
- Permanent and waterproof
- Woven polyethylene fabric, solid-coated with adhesive
- Can be applied in below freezing conditions
- Use for repairing or seaming bottom board, tarps

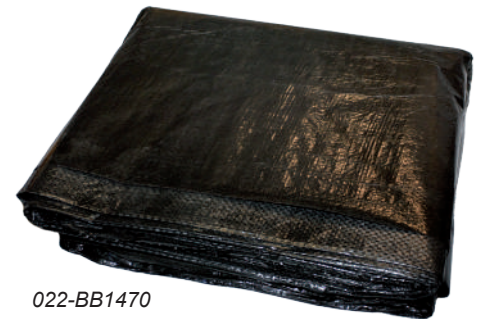

022-BB1470

<b>022-BP4180</b>	4in x 60yds (101mm x 54.8m)	Black
<b>022-BP6180</b>	6in x 60yds (152mm x 54.8m)	Black
<b>022-BP2825</b>	28in x 25ft (711mm x 7.62m)	Black
<b>022-BP2850</b>	28in x 50ft (711mm x 15.24m)	Black
<b>022-BB1470</b>	14ft x 70ft (non-adhesive)	Black

## Painter's Grade Blue Tape

- Medium tack, rubber adhesive
- Residue free
- Suitable for 14 day clean removal



## Silver Foil Tape

- Used for vapor barrier protection, waterproof sealing, heat reflection & dissipation, masking in paint stripping and electroplating
- Malleable foil conforms well to irregular and curved surfaces
- Performs well at both low and elevated temperatures



<b>022-BT1180</b>	1in x 60yds (24mm x 54.8m)	Blue
<b>022-BT15180</b>	1.5in x 60yds (36mm x 54.8m)	Blue
<b>022-BT2180</b>	2in x 60yds (48mm x 54.8m)	Blue

<b>022-AFT322</b>	2in x 150ft (48mm x 50yds)	Silver
-------------------	----------------------------	--------

## Utility Grade Duct Tape

- Versatile polyethylene coated cloth tape
- High tack adhesive bond
- Easy tear cloth tape



## Close Up Tapes

- White conformable polyethylene film single coated with an aggressive, low residue natural rubber pressure sensitive adhesive formulation
- Use for splicing, seaming, patching and holding of poly sheeting such as close off poly films, floor protective poly films and air barrier house wrap films



<b>022-DUG48S</b>	2in x 60yds (48mm x 54.8m)	Silver
<b>022-DUG48B</b>	2in x 60yds (48mm x 54.8m)	Black

<b>022-1362</b>	2in x 180ft	White
<b>022-1364</b>	4in x 180ft	White

## Sika® Silicon Products

### SikaSil GP

- SikaSil GP is a silicone sealant used in interior and exterior RV applications
- It has excellent adhesion to metal, glass, plastic & fiberglass, has excellent weather stability, is solvent free, and is mold & mildew resistant.

AP Part#	Description
017-189150	SikaSil GP Clear Silicone 295 ML cart
017-189151	SikaSil GP White Silicone 295 ML cart



### Sikasil® WS-290

- Sikasil® WS-290 is a silicone sealant that cures to a durable, flexible building sealant.
- Sikasil® WS-290 performs exceptionally well due to its strong adhesion to building materials, UV Resistant

AP Part#	Description
017-412128	SikaSil WS-290 Low mod Black 295 ML cart
017-412302	SikaSil WS-290 Low mod Limestone 295 ML cart
017-412301	SikaSil WS-290 Low mod Med Bronze 295 ML cart
017-412300	SikaSil WS-290 Low mod Bronze 295 ML cart
017-412304	SikaSil WS-290 Low mod Colonial White 295 ML cart



### Sikasil® N-Plus

- Sikasil® N-Plus is a general purpose silicone sealant used for interior and exterior applications
- Provides adhesion to most substrates without surface treatments
- Sikasil® N-Plus is highly UV resistant with excellent weather stability and is mold and mildew resistant

AP Part#	Description
017-412406	SikaSil N Plus Clear 295 ML cart
017-415697	SikaSil N Plus Aluminum Gray 295 ML cart
017-412136	SikaSil N Plus White 295 ML cart



### Sika® Multiseal Plus

- Sika MultiSeal Plus is a self-adhering, multi-purpose roofing repair tape
- Combines an advanced copolymer mastic that exhibits aggressive adhesion
- Flexible, tear proof, UV resistant
- Creates a permanent watertight seal
- Bonds to a wide range of surfaces including roof materials
- Can be stretched, cut and folded around intricately shaped roofing



AP Part#	Description	Color
017-413832	2" x 50' Roll	White Membrane
017-413830	3" x 50' Roll	White Membrane
017-413828	4" x 50' Roll	White Membrane
017-404033	6" x 50' Roll	White Membrane
017-413827	2" x 50' Roll	Gray Membrane
017-413831	3" x 50' Roll	Gray Membrane
017-413829	4" x 50' Roll	Gray Membrane
017-404096	6" x 50' Roll	Black Membrane
017-413828-5	4" x 5' Roll	White Membrane
017-413828-25	4" x 25' Roll	White Membrane

### Sika® Aktivator/Cleaner 205

- Sika®-Aktivator/Cleaner 205 is a solution for pretreating surfaces prior to sealing with Sikaflex® products
- Improves adhesion and provides a weather-resistant bond on plastics, paints and lacquer finishes



AP Part#	Description
017-108616	Sika Aktivator/Cleaner 205 250 ML Bottle

### Sikaflex® 201

- Sikaflex® 201 is a moisture curing polyurethane with great elasticity
- This flexible sealant is weather resistant, sandable and paintable, non-sagging, flexible and durable

AP Part#	Description
017-90852	Sikaflex 201 White 300 ML cart
017-108220	Sikaflex 201 Tan 300 ML cart





# Sika® Silicon Products

## Sikaflex® 221

- Sikaflex® 221 is the most well known brand of polyurethane sealant/adhesives
- This fast curing product provides permanent adhesion to surfaces with excellent cut and tear resistance
- Sikaflex® 221 is weather resistant, sandable, paintable and NSF approved for potable water and incidental food contact

AP Part#	Description
017-90892	Sikaflex 221 Alum Gray 300 ML cart
017-90893	Sikaflex 221 Black 300 ML cart
017-106449	Sikaflex 221 Colonial White 300 ML cart
017-90891	Sikaflex 221 White 300 ML cart



## Sikaflex® 252

- Sikaflex® 252 offers superior adhesive strength
- Provides excellent gap filling qualities and compensates for loose tolerances in building processes
- Strong enough to reduce traditional fastening systems such as welds, rivets, screw and bolts. Bonds to a wide variety of substrates. Sandable, paintable and NSF approved for incidental food contact.

AP Part#	Description
017-90915	Sikaflex 252 White 10.5 oz cart
017-90916	Sikaflex 252 Black 10.5 oz cart



## Sikaflex® 291

- Sikaflex® 291 is a polyurethane adhesive and sealant
- Fast curing time makes it ideal for applications where speed is important
- Offers excellent adhesion to gelcoat, fiberglass, metal and wood.
- Can be brushed in place and can be sanded after curing.

AP Part#	Description
017-90919	Sikaflex 291 White 300 ML cart
017-90923	Sikaflex 291 Black 300 ML cart



## SikaflexV® 505 UV HV

- Sikaflex® 505 UV HV is a sealant containing no solvents and is excellent for UV and weathering resistance
- Offers excellent adhesion to a wide variety of substrates with little or no surface treatment, has excellent tooling characteristics and is non-yellowing

AP Part#	Description
017-415763	Sikaflex 505 UV HV White 300 ML cart



## Sikaflex® 715

- Sikaflex® 715 is a flexible, elastic, and durable roof sealant
- Will bond to a variety of roofing component substrates and won't crack under the most extreme conditions
- Traditional roof sealants have high shrink characteristics and crack when exposed to the environment.

AP Part#	Description
017-187690	Sikaflex 715 Roof Sealant 300 ML cart

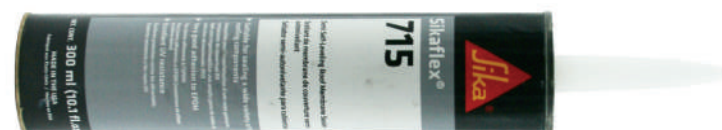

## STA-PUT Spray Adhesive

### Miracle® Spray Adhesive (SPM)

- Miracle® SPM-1330 spray adhesive is formerly known as STA-PUT® SPM
- Specifically formulated aerosol for bonding fiberglass onto sheet metal, corner bead to drywall, or urethane foam to wood, metal or cloth.
- Offers quick tack and a strong bond
- Exhibits high strength bonds, aggressive grab tack and reduced application time

Part#	Description	Quantity
001-SPM17ACC	STA-PUT Spray Adhesive	17 oz.



### STA-PUT Spray Adhesive for Polystyrene Foam (SPII)

- STA'-PUT SPII is a pressure sensitive adhesive specifically formulated for bonding expanded polystyrene foam (EPS) to itself and other materials
- Exceptional tack properties, excellent choice for temporary and permanent EPS applications.
- SPII provides high strength, heat/UV stability, water resistance, and fast drying
- Suitable for manufactured housing, RV, marine, refrigeration, and general construction uses
- It can also be used on porous and many non-porous surfaces. *The ideal application temperature for STA'-PUT is 70°F/38°C.*

Part#	Description	Quantity
001-SP213ACC	STA-PUT Spray Adhesive for Polystyrene Foam	13 oz.



### STA-PUT Adhesive Remover (SPR)

- STA'-PUT S203 is a biodegradable, natural solvent cleaner, degreaser and adhesive remover
- Can be used safely on painted surfaces, glass, porcelain, concrete, plastics and vinyl
- S203 can be used to remove adhesives, grease, oil stains, road tar, and rubber marks  
*The ideal application temperature for STA'-PUT is 70°F/38°C.*

Part#	Description	Quantity
001-S203	STA-PUT S203 Clear	14 oz.



### STA-PUT Spray Adhesive Clear (SPH)

- Superior bond strength properties and exceptional tack makes SPH an excellent choice for most permanent adhesive applications
- High shear strength, heat/UV stable, water resistance, and fast drying
- Pressure sensitive qualities suitable for manufactured housing, general construction, RV, marine, woodworking, furniture, textile, HVAC, and upholstery
- Can be used on porous and many non-porous surfaces. *The ideal application temperature for STA-PUT is 70°F/38°C.*

Part#	Description	Quantity
001-SPH15ACC	STA-PUT Spray Adhesive Clear	15 oz.



## Spray Paint



003-55273



003-55274



003-55275

### Dap Touch 'N Tone

Part#	Description	Color	Qty.
003-55273	10 oz. Sprays	Aluminum	6
003-55274	10 oz. Sprays	Gloss White	6
003-55275	10 oz. Sprays	Flat Black	6
003-55276	10 oz. Sprays	Gloss Black	6
003-55279	10 oz. Sprays	Primer Gray	6
003-55280	10 oz. Sprays	Flat White	6
003-55281	10 oz. Sprays	Antique White	6
003-55285	10 oz. Sprays	Almond	6
003-55288	10 oz. Sprays	Dove Gray	6



003-55281



003-55285



003-51110



003-51103



003-51107

### Spray 'N Go Fast Dry Decorative Enamel

Part#	Description	Color	Qty.
003-51103	12 oz. Sprays	Gloss White	6
003-51104	12 oz. Sprays	Gloss Black	6
003-51110	12 oz. Sprays	Flat Black	6
003-51127	12 oz. Sprays	Gray Primer	6



## Tools

### Hand Nut Drivers



- 009-ND1/4** 1/4 Drive 6-1/2" Long with Large Handle (Not Carded)
- 009-ND1/4C** 1/4 Drive 6-1/2" Long with Large Handle (Carded)
- 009-NDL1/4** 1/4 Drive 9-1/2" Long with Large Handle (Not Carded)
- 009-NDL1/4C** 1/4 Drive 9-1/2" Long with Large Handle (Carded)
- 009-ND5/16** 5/16 Drive 6-1/2" Long with Large Handle (Not Carded)
- 009-ND5/16C** 5/16 Drive 6-1/2" Long with Large Handle (Carded)
- 009-ND3/8** 3/8 Drive 6-1/2" Long with Large Handle (Not Carded)
- 009-ND3/8C** 3/8 Drive 6-1/2" Long with Large Handle (Carded)

### Combination Screwdrivers



- 009-4-IN1CRC** 7-1/2 O.A.L. 5/16 Drive, #1 & #2 Square, 5/16 Drive 5/32 & 3/16 Clutch (Carded)
- 009-4-IN1PRC** 7-1/2 O.A.L. 5/16 Drive, #1 & #2 Phillips, 5/16 Drive #1 & #2 Square (Carded)
- 009-4IN-1PSR** 7-1/2 O.A.L. 5/16 Drive, #1 Phil & 3/16 Slot, 5/16 Drive #1 & #2 Square (Not Carded)
- 009-6IN-1PRC** 7-1/2 O.A.L. 1/4 Drive, #1 & #2 Phil, #1 & #2 Square (Carded)
- 009-PC2-IN-1C** 4-3/4 O.A.L. 3/16 Drive, #1 Phil & 3/16 Slot, with Pocket Clip (Carded)

### Square Recess Screwdrivers



- 009-HDQB0** #0 Point Standard Model (Not Carded)
- 009-HDQB0C** #0 Point Standard Model (Carded)
- 009-HDQB1** #1 Drive Standard Model (Not Carded)
- 009-HDQB1C** #1 Drive Standard Model (Carded)
- 009-HDQB2** #2 Drive Standard Model (Not Carded)
- 009-HDQB2C** #2 Drive Standard Model (Carded)
- 009-HDQB3** #3 Drive Standard Model (Not Carded)
- 009-HDQB3C** #3 Drive Standard Model (Carded)
- 009-HDQB2L** #2 Drive Large Handle (Not Carded)
- 009-HDQB2LC** #2 Drive Large Handle (Carded)
- 009-QD1** #1 Drive Economy Model (Not Carded)
- 009-QD1C** #1 Drive Economy Model (Carded)
- 009-QD2** #2 Drive Economy Model (Not Carded)
- 009-QD2C** #2 Drive Economy Model (Carded)

### Torx Screwdrivers



- 009-HDT15** #15 Drive Plastic Handle (Not Carded)
- 009-HDT15C** #15 Drive Plastic Handle (Carded)
- 009-HDT20** #20 Drive Plastic Handle (Not Carded)
- 009-HDT20C** #20 Drive Plastic Handle (Carded)

### Clutch Screwdrivers



- 009-C3** 5/32 Drive Plastic Handle (Not Carded)
- 009-C3C** 5/32 Drive Plastic Handle (Carded)
- 009-C4C** 3/16 Drive Plastic Handle (Carded)

### 16-In-1 Screwdriver



- 009-16-IN-1** #0 & #1 Phillips, #2 & #3 Phillips, 3/16 & 1/4 Slotted, 5/32 & 7/32 Slotted, #0 & #1 Square, #2 & #3 Square, #10 & #15 Torx, #20 & #25 Torx (Carded)

**Magnetic Screwdrivers**



**009-M5 IN 1 LTC** Aluminum 8" O.A.L. 000T10 Torx, 000T15 Torx, 000T20 Torx, 000T25 Torx, and 000T30 Torx (Carded)

**009-M5IN1PST** Aluminum 8" O.A.L. 5/16 Nut Setter, 1/4 Nut Setter, #1 & #2 Phillips, #4 & #8 Slotted (Not Carded)

**009-M5IN1PSTC** Aluminum 8" O.A.L. 5/16 Nut Setter, 1/4 Nut Setter, #1 & #2 Phillips, #4 & #8 Slotted (Carded)

**009-M6 IN 1 MC** Aluminum 8" O.A.L. 250SS6 Slot, 250SS8 Slot, 4P1 & 4P2 & 4P3 Phil, 000F2 Frearson (Carded)

**009-RVM5IN1AB** Aluminum 8" O.A.L. 250SS8 Slot, 4P2 Phil, 250 RI Square, 250R2 Square, & 000C3 Clutch (Not Carded)

**009-RVM5IN1AC** Aluminum 8" O.A.L. 250SS8 Slot, 4P2 Phil, 250R1 Square, 250R2 Square, and 000C3 Clutch (Carded)

**009-RVM5IN1SSB** Stainless 8" O.A.L. 250SS8 Slot, 4P2 Phil, 250R1 Square, 250R2 Square, and 000C3 Clutch (Not Carded)

**009-RVM5IN1SSC** Stainless 8" O.A.L. 250SS8 Slot, 4P2 Phil, 250R1 Square, 250R2 Square, and 000C3 Clutch (Carded)

**009-RVM51BSC** Replacement Bits For RVM5IN1 250SS8 Slot, 4P2 Phil, 250R1 Square, 250R2 Square, and 000C3 Clutch

**Screwdriver Kits**

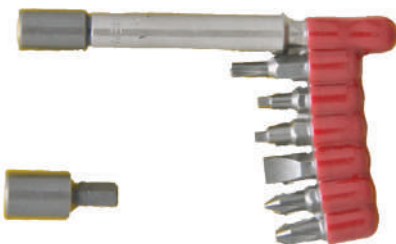

**009-TT9** Includes: ND1/4 Hand Nut Driver, 4-IN-1 Combination Screwdriver, 4-IN-1CR Combination Screwdriver, SA37W Awl (Bagged)

**Pipe Cutters**



**009-MPC1** For use on 1/8" - 5/8" Copper, Brass, or Aluminum Tubing (Not Carded)

**009-PC2** For use on 1/8" - 1-1/8" Copper, Brass, or Aluminum Tubing (Not Carded)

**Flaring Tools**



**009-TFT3** For 3/16" - 5/8" O.D. Tubing (Not Carded)

**Aluminum/Aluminum Blind Rivets**



**009-AA42D100** 1/8 Rivet Diam, 1/8 Grip Range, 100/box

**009-AA66D100** 3/16 Rivet Diam, 3/8 Grip Range, 100/box

**009-AA68D100** 3/16 Rivet Diam, 1/2 Grip Range, 100/box

# Slotted And Phillips Bits

## Phillips Power Bits

Part#	Description
009-42P1	1/4 X 2" Drive by Lgth, #1 (Not Carded)
009-42P1C	1/4 X 2" Drive by Lgth, #1 (Carded)
009-42P2	1/4 X 2" Drive by Lgth, #2 (Not Carded)
009-42P2C	1/4 X 2" Drive by Lgth, #2 (Carded)
009-42P3	1/4 X 2" Drive by Lgth, #3 (Not Carded)
009-42P3C	1/4 X 2" Drive by Lgth, #3 (Carded)
009-43P1	1/4 X 2-3/4" Drive by Lgth, #1 (Not Carded)
009-43P2	1/4 X 2-3/4" Drive by Lgth, #2 (Not Carded)
009-43P2C	1/4 X 2-3/4" Drive by Lgth, #2 (Carded)
009-43P3C	1/4 X 2-3/4" Drive by Lgth, #3 (Carded)
009-46P1	1/4 X 6" Drive by Lgth, #1 (Not Carded)
009-46P2	1/4 X 6" Drive by Lgth, #2 (Not Carded)
009-46P2C	1/4 X 6" Drive by Lgth, #2 (Carded)



## Phillips Insert Bits

Part#	Description
009-4P1	1/4 X 1" Drive by Lgth, #1 (Not Carded)
009-4P2	1/4 X 1" Drive by Lgth, #2 (Not Carded)
009-4P2C	1/4 X 1" Drive by Lgth, #2 (Carded)
009-4P3	1/4 X 1" Drive by Lgth, #3 (Not Carded)
009-4P3C	1/4 X 1" Drive by Lgth, #3 (Carded)
009-4P3C	1/4 X 2-3/4" Drive by Lgth, #1 (Not Carded)



## Star Insert Bits

Part#	Description
009-000T15	1/4 X 1" Drive by Lgth, #15 (Not carded)
009-000T15C	1/4 X 1" Drive by Lgth, #15 (Carded)
009-000T20	1/4 X 1" Drive by Lgth, #20 (Not carded)
009-000T20C	1/4 X 1" Drive by Lgth, #20 (Carded)
009-000T25	1/4 X 1" Drive by Lgth, #25 (Not carded)
009-000T25C	1/4 X 1" Drive by Lgth, #25 (Carded)
009-000T40	1/4 X 1" Drive by Lgth, #40 (Not carded)
009-000T40C	1/4 X 1" Drive by Lgth, #40 (Carded)



## Slotted Power Bits

Part#	Description
009-20-6S	1/4 X 1-15/16" Drive by Lgth, 5F-6R (Not carded)
009-20-7S	1/4 X 1-15/16" Drive by Lgth, 6F-7R (Not carded)
009-20-8S	1/4 X 1-15/16" Drive by Lgth, 8F-10R (Not carded)



## Slotted Insert Bits

Part#	Description
009-250SS6	1/4 X 1" Drive by Lgth, 6F-7R (Not carded)
009-250SS6C	1/4 X 1" Drive by Lgth, 6F-7R (Carded)
009-250SS8	1/4 X 1" Drive by Lgth, 8F-10R (Not carded)
009-250SS10	1/4 X 1" Drive by Lgth, 12F-14R (Not carded)



## Double End Bit

009-DEB28	1/4 Hex Drive 2" Lgth, Screw Size #2 Phillips & #8 Slotted (Not carded)
-----------	---





# Square Recess And Clutch Bits

## Square Recess Power Bits

Part#	Description
009-250QB2P3C	1/4 X 3" Drive by Lgth, #2 (Carded)
009-250QB3P3C	1/4 X 3" Drive by Lgth, #3 (Carded)
009-250QB2P4	1/4 X 4" Drive by Lgth, #2 (Not Carded)
009-250QB2P4C	1/4 X 4" Drive by Lgth, #2 (Carded)
009-250QB2P6	1/4 X 6" Drive by Lgth, #2 (Not Carded)
009-250QB2P6C	1/4 X 6" Drive by Lgth, #2 (Carded)
009-250QB1P	1/4 X 2" Drive by Lgth, #1 (Not Carded)
009-250QB1PC	1/4 X 2" Drive by Lgth, #1 (Carded)
009-250QB2P	1/4 X 2" Drive by Lgth, #2 (Not Carded)
009-250QB2PC	1/4 X 2" Drive by Lgth, #2 (Carded)
009-250QB3P	1/4 X 2" Drive by Lgth, #3 (Not Carded)
009-250QB3PC	1/4 X 2" Drive by Lgth, #3 (Carded)
009-250QB1P3C	1/4 X 3" Drive by Lgth, #1 (Carded)
009-250QB2P3	1/4 X 3" Drive by Lgth, #2 (Not Carded)



## Square Recess Insert Bits

Part#	Description
009-250R1	1/4 X 1" Drive by Lgth, #1 (Not Carded)
009-250R1C	1/4 X 1" Drive by Lgth, #1 (Carded)
009-250R2	1/4 X 1" Drive by Lgth, #2 (Not Carded)
009-250R2C	1/4 X 1" Drive by Lgth, #2 (Carded)
009-250R3C	1/4 X 1" Drive by Lgth, #3 (Carded)



## Magnetic Reversible Socket

009-MRS1/4C	Straight 1/4" Hex, 1" Drive by Lgth (Carded)
-------------	--



## Magnetic Power Bit Holder

009-304CR	1/4 X 3" Drive by Lgth, 1/4 (Not Carded)
009-304CRC	1/4 X 3" Drive by Lgth, 1/4 (Carded)



## Clutch Power Bits

Part#	Description
009-100A2	1/4X1-15/16" Drive by Lgth, 1/8-A (Not Carded)
009-100A2C	1/4X1-15/16" Drive by Lgth, 1/8-A (Carded)
009-100A3	1/4X1-15/16" Drive by Lgth, 5/32-A (Not Carded)
009-100A3C	1/4X1-15/16" Drive by Lgth, 5/32-A (Carded)
009-100A4	1/4X1-15/16" Drive by Lgth, 3/16-A (Not Carded)
009-100A4C	1/4X1-15/16" Drive by Lgth, 3/16-A (Carded)
009-100C3	1/4X1-15/16" Drive by Lgth, 5/32-G (Not Carded)
009-100C3C	1/4X1-15/16" Drive by Lgth, 5/32-G (Carded)
009-100C4	1/4X1-15/16" Drive by Lgth, 3/16-G (Not Carded)
009-100C4C	1/4X1-15/16" Drive by Lgth, 3/16-G (Carded)



## Clutch Insert Bits

Part#	Description
009-000A3	1/4 X 1-1/4" Drive by Lgth, 5/32-A
009-000A3C	1/4 X 1-1/4" Drive by Lgth, 5/32-A (Carded)
009-000A4	1/4 X 1-1/4" Drive by Lgth, 3/16-A (Not Carded)
009-000A4C	1/4 X 1-1/4" Drive by Lgth, 3/16-A (Carded)
009-000C3	1/4 X 1-1/4" Drive by Lgth, 5/32-G (Not Carded)
009-000C3C	1/4 X 1-1/4" Drive by Lgth, 5/32-G (Carded)
009-000C4	1/4 X 1-1/4" Drive by Lgth, 3/16-G (Not Carded)



## Non-Magnetic Power Bit Holder

009-BH1/4	1/4 X 2" Drive by Lgth, 1/4 (Not Carded)
-----------	--



# Sockets And Nutsetters

## Magnetic Sockets



<b>009-250MS1/4</b>	Shoulder 1/4" Square Driver, Lgth 1, Drive 1/4 (Not Carded)
<b>009-250MST1/4</b>	Tapered 1/4" Square Driver, Lgth 1, Drive 1/4 (Not Carded)
<b>009-250MST1/4C</b>	Tapered 1/4" Square Driver, Lgth 1, Drive 1/4 (Carded)
<b>009-250MS5/16</b>	Shoulder 1/4" Square Driver, Lgth 1, Drive 5/16 (Not Carded)
<b>009-250MS5/16C</b>	Shoulder 1/4" Square Driver, Lgth 1, Drive 5/16 (Carded)
<b>009-250MST5/16</b>	Tapered 1/4" Square Driver, Lgth 1, Drive 5/16 (Not Carded)
<b>009-250MST5/16C</b>	Tapered 1/4" Square Driver, Lgth 1, Drive 5/16 (Carded)
<b>009-250MS3/8</b>	Tapered 1/4" Square Driver, Lgth 1, Drive 3/8 (Not Carded)
<b>009-250MS3/8C</b>	Tapered 1/4" Square Driver, Lgth 1, Drive 3/8 (Carded)

## Magnetic Power Nutsetters



<b>009-104</b>	1/4X1-3/4" Drive by Lgth, 1/4 (Not Carded)
<b>009-104C</b>	1/4X1-3/4" Drive by Lgth, 1/4 (Carded)
<b>009-104-50</b>	1/4X1-3/4" Drive by Lgth, 1/4 (50 Piece Box)
<b>009-105</b>	1/4X1-3/4" Drive by Lgth, 5/16 (Not Carded)
<b>009-105C</b>	1/4X1-3/4" Drive by Lgth, 5/16 (Carded)
<b>009-106</b>	1/4X1-3/4" Drive by Lgth, 3/8 (Not Carded)
<b>009-106C</b>	1/4X1-3/4" Drive by Lgth, 3/8 (Carded)
<b>009-MSH7/16</b>	1/4X1-3/4" Drive by Lgth, 7/16 (Carded)
<b>009-134</b>	1/4X2-9/16" Drive by Lgth, 1/4 (Not Carded)
<b>009-134C</b>	1/4X2-9/16" Drive by Lgth, 1/4 (Carded)
<b>009-135</b>	1/4X2-9/16" Drive by Lgth, 5/16 (Not Carded)
<b>009-136</b>	1/4X2-9/16" Drive by Lgth, 3/8 (Not Carded)
<b>009-136C</b>	1/4X2-9/16" Drive by Lgth, 3/8 (Carded)
<b>009-MSHL1/4-4</b>	1/4 X 4" Drive by Lgth, 1/4 (Not Carded)
<b>009-MSHL1/4-4C</b>	1/4 X 4" Drive by Lgth, 1/4 (Carded)
<b>009-MSHL1/4-6</b>	1/4 X 6" Drive by Lgth, 1/4 (Not Carded)
<b>009-MSHL1/4-6C</b>	1/4 X 6" Drive by Lgth, 1/4 (Carded)

## Magnetic Power Tapered Nutsetters



<b>009-MSHB1/4</b>	1/4 X 2" Drive by Lgth, 1/4 (Not Carded)
<b>009-MSHB1/4C</b>	1/4 X 2" Drive by Lgth, 1/4 (Carded)

## Magnetic Insert Nutsetters



<b>009-MSHS1/4</b>	1/4X1-1/8" Drive by Lgth, 1/4 (Not Carded)
<b>009-MSHS1/4C</b>	1/4X1-1/8" Drive by Lgth, 1/4 (Carded)

## MH/RV Screws - Unslotted Hex Washer Head

Part #	Ctn. Qty.	Mstr. Ctn.	Ctn. Wgt.	Finish
012-TRB-8 x 1/2	15M		44.25	Zinc/Painted
012-TRB-8 x 3/4	9.6M		39.50	Zinc/Painted
012-TRB-8 x 1	7.5M		39.60	Zinc/Painted
012-TRB-8 x 1-1/4	6M		35.70	Zinc/Painted
012-TRB-8 x 1-1/2	6.5M		34.75	Zinc/Painted
012-TRB-8 x 2	3.5M		32.00	Zinc/Painted
012-TRB-8 x 2-1/2	3M		36.00	Zinc/Painted
012-TR1000-8 x 1/2	1M	10M	33	Zinc/Painted
012-TR1000-8 x 3/4	1M	10M	42	Zinc/Painted
012-TR1000-8 x 1	1M	10M	53	Zinc/Painted
012-TR1000-8 x 1-1/4	1M	10M	70	Zinc/Painted
012-TR1000-8 x 1-1/2	1M	10M	78	Zinc/Painted
012-TR500-8 x 1/2	500	5M	18	Zinc/Painted
012-TR500-8 x 3/4	500	5M	22	Zinc/Painted
012-TR500-8 x 1	500	5M	28	Zinc/Painted
012-TR500-8 x 1-1/4	500	5M	32	Zinc/Painted
012-TR500-8 x 1-1/2	500	5M	37	Zinc/Painted
012-TR250-8 x 2	250	2.5M	24	Zinc/Painted
012-TR100-8 x 1/2	100	1M	4	Zinc/Painted
012-TR100-8 x 1	100	1M	6	Zinc/Painted
012-TR100-8 x 1-1/4	100	1M	7	Zinc/Painted
012-TR100-8 x 1-1/2	100	1M	8	Zinc/Painted
012-TR100-8 x 2	100	1M	10	Zinc/Painted
010-TR50-8 x 1/2	50	500	2	Zinc/Painted
012-TR50-8 x 3/4	50	500	4	Zinc/Painted
012-TR50-8 x 1	50	500	4	Zinc/Painted
012-TR50-8 x 1-1/2	50	500	5	Zinc/Painted
012-TR50-8 x 2	50	500		Zinc/Painted
012-TR100-10 x 1	100	1M		Zinc
012-TR100-10 x 2	100	1M		Zinc

### Ordering Painted Screws (may fall under special order):

Stocking colors: (W) Polar White, (BL) Black, (BR) Brown, (CO) Colonial White, (BZ) Bronze.

To indicate color, insert color code into part # blank. Example: 012-TR1000W8x1/2



## Square Recess Screws - Pan Head

Part #	Ctn. Qty.	Mstr. Ctn.	Ctn. Wgt.	Finish
012-PSQB-8 x 3/4	9.6M			Zinc/Painted/Bronze
012-PSQB-8 x 1	7.5M			Zinc/Painted/Bronze
012-PSQB-8 x 1-1/4	6M	36		Zinc/Painted/Bronze
012-PSQB-8 x 1-1/2	5M	35		Zinc/Painted/Bronze
012-PSQB-8 x 2	3.5M			Zinc/Painted/Bronze
012-PSQB-8 x 3	1.5M			Zinc/Bronze
012-PSQ1000-8 x 5/8	1M	10M	40	Zinc
012-PSQ1000-8 x 3/4	1M	10M	42	Zinc/Painted/Bronze
012-PSQ1000-8 x 1	1M	10M	53	Zinc/Painted/Bronze
012-PSQ1000-8 x 1-1/4	1M	10M	70	Zinc/Painted/Bronze
012-PSQ1000-8 x 1-1/2	1M	10M	78	Zinc/Painted/Bronze
012-PSQ500-8 x 3/4	500	5M	21	Zinc/Painted/Bronze
012-PSQ500-8 x 1	500	5M	25	Zinc/Painted/Bronze
012-PSQ500-8 x 1-1/4	500	5M	29	Zinc/Painted/Bronze
012-PSQ500-8 x 1-1/2	500	5M	35	Zinc/Painted/Bronze
012-PSQ500-8 x 3	500	5M		Zinc/Bronze
012-PSQ250-8 x 2	250	2.5	23	Zinc/Painted
012-PSQ100-8 x 3	100	1M	16	Zinc/Bronze
012-PSQ50-8 x 3/4	50	500	3	Zinc/Painted/Bronze
012-PSQ50-8 x 1	50	500	3	Zinc/Painted/Bronze
012-PSQ50-8 x 1-1/4	50	500	4	Zinc/Painted/Bronze
012-PSQ50-8 x 1-1/2	50	500	4	Zinc/Painted/Bronze

### Ordering Painted Screws (may fall under special order):

Stocking colors: (W) Polar White, (BL) Black, (BR) Brown, (CO) Colonial White, (BZ) Bronze.

To indicate color, insert color code into part # blank.





## Screws

### Unslotted Hex Washer Head Self Drilling - Zinc Plate

Part #	Ctn. Qty.	Mst. Ctn.	Ctn. Wgt.	Finish
012-DPB 8 x 1-1/4	6M			Zinc
012-DP500 8 x 1/2	500	5M	18	Zinc
012-DP500 8 x 3/4	500	5M	24	Zinc
012-DP500 8 x 1	500	5M	29	Zinc
012-DP500 8 x 1-1/4	500	5M	32	Zinc
012-DP500 8 x 1-1/2	500	5M	38	Zinc
012-DP100 8 x 1/2	100	1M	4	Zinc
012-DP100 8 x 3/4	100	1M	5	Zinc
012-DP100 8 x 1	100	1M	6	Zinc
012-DP100 8 x 1-1/2	100	1M	8	Zinc
012-DP50 8 x 1/2	50	500	2	Zinc
012-DP50 8 x 3/4	50	500	4	Zinc
012-DP50 8 x 1	50	500	4	Zinc
012-DP50 8 x 1-1/4	50	500	5	Zinc
012-DP50 8 x 1-1/2	50	500	5	Zinc
012-DP100 10 x 5/8	100	1M		Zinc
012-DP100 10 x 3/4	100	1M		Zinc
012-DP100 10 x 1	100	1M		Zinc
012-DP100 10 x 1-1/2	100	1M		Zinc
012-DP3/8B 14 x 3/1				Zinc
012-DP3/8B 14 x 1				Zinc
012-DP3/8 500 14 x 3/4	500			Zinc
012-DP3/8 500 14 x 1	500			Zinc
012-DP3/8 100 14 x 3/4	100			Zinc
012-DP3/8 100 14 x 1	100			Zinc

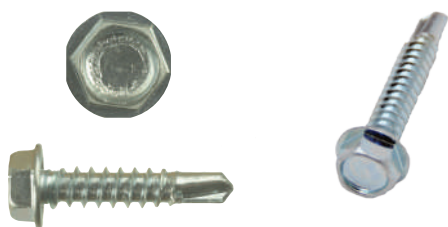

### Flat Head - Square Recess Screws

Part #	Ctn. Qty.	Mstr. Ctn.	Ctn. Wgt.	Finish
012-FSQB-8 x 1	10M			Raw/Zinc
012-FSQB-8 x 1-1/2	8M			Raw/Bronze/Black/Zinc
012-FSQB-8 x 2	4.5M			Raw/Bronze/Black/Zinc
012-FSQB-8 x 2-1/2	2M			Raw/Bronze/Black/Zinc
012-FSQB-8 x 3	1M			Raw/Bronze/Black/Zinc
012-FSQB-8 x 4	1,000M			Raw
012-FSQ1000-8 x 1	1M	10M		Raw/Zinc
012-FSQ1000-8 x 1-1/2	1M	10M		Raw/Bronze/Black/Zinc
012-FSQ500-8 x 1	500	5M		Raw/Zinc
012-FSQ500-8 x 1-1/2	500	5M		Raw/Bronze/Black/Zinc
012-FSQ500-8 x 2	500	5M		Raw/Bronze/Black/Zinc
012-FSQ500-8 x 2-1/2	500	5M		Raw/Bronze/Black/Zinc
012-FSQ500-8 x 3	500	5M		Raw/Bronze/Black/Zinc
012-FSQ250-8 x 1-1/2	250	2.5M		Raw/Bronze/Black/Zinc
012-FSQ250-8 x 2	250	2.5M		Raw/Bronze/Black/Zinc
012-FSQ100-8 x 1-1/2	100	1M		Raw/Bronze/Black/Zinc
012-FSQ100-8 x 2	100	1M	10	Raw/Bronze/Black/Zinc
012-FSQ100-8 x 2-1/2	100	1M		Raw/Bronze/Black/Zinc
012-FSQ100-8 x 3	100	1M		Raw/Bronze/Black/Zinc
012-FSQ100-8 x 4	100	1M		Raw/Black/Zinc
012-FSQ25-8 x 1-1/2	25	250	2	Raw/Bronze/Black/Zinc
012-FSQ25-8 x 2	25	250	3	Raw/Bronze/Black/Zinc
012-FSQ25-8 x 2-1/2	25	250	3	Raw/Bronze/Black/Zinc

#### Ordering Painted Screws (may fall under special order):

Stocking colors: (W) Polar White, (BL) Black, (BR) Brown, (CO) Colonial White, (BZ) Bronze.

To indicate color, insert color code into part # blank.



## Tri-Screws - Pan Head Self Drilling - Zinc

Part #	Ctn. Qty.	Mstr. Ctn.	Ctn. Wgt.	Finish
012-PTKB 8 x 1-1/2	5M			Zinc
012-PTK 500 8 x 3/4	500			Zinc
012-PTK 500 8 x 1	500			Zinc
012-PTK 500 8 x 1-1/2	500			Zinc
012-PTK 100 8 x 3/4	100			Zinc
012-PTK 100 8 x 1	100			Zinc
012-PTK 100 8 x 1-1/2	100			Zinc



## Tri-Drive Oval Head Screws

Part #	Ctn. Qty.	Mstr. Ctn.	Ctn. Wgt.	Finish
012-RTB-6 x 1	11M			Zinc/Painted
012-RTB-6 x 1-1/2	10M			Zinc/Painted
012-RT 500-6 x 1	500			Zinc
012-RT 500-6 x 1-1/2	500			Zinc/Painted
012-RT200-6 x 1-1/2	200	2M		Zinc/Painted
012-RT100-6 x 1	100			Zinc
012-RT100-6 x 1-1/2	100			Painted

**Ordering Painted Screws** (may fall under special order):  
Stocking colors: (W) Polar White, (BL) Black, (BR) Brown,  
(CO) Colonial White, (BZ) Bronze.  
To indicate color, insert color code into part # blank.



## Pan Washer Head - Tri Screws

Part #	Ctn. Qty.	Mstr. Ctn.	Ctn. Wgt.	Finish
012-PTWB-8 x 3	2M			Zinc
012-PTW1000-8 x 3/4	1M	10M		Zinc
012-PTW1000-8 x 1	1M	10M		Zinc
012-PTW1000-8 x 1-1/4	1M	10M		Zinc
012-PTW1000-8 x 1-1/2	1M	10M		Zinc
012-PTW500-8 x 3/4	500	5M	22	Zinc
012-PTW500-8 x 1	500	5M	28	Zinc
012-PTW500-8 x 1-1/2	500	5M	37	Zinc
012-PTW500-8 x 2	500	5M	46	Zinc
012-PTW500-8 x 3	500	5M	64	Zinc
012-PTW100-8 x 3/4	100	1M	5	Zinc
012-PTW100-8 x 1	100	1M	6	Zinc/White
012-PTW100-8 x 1-1/2	100	1M	8	Zinc
012-PTW100-8 x 2	100	1M	10	Zinc

**Ordering Painted Screws** (may fall under special order):  
Stocking colors: (W) Polar White, (BL) Black, (BR) Brown,  
(CO) Colonial White, (BZ) Bronze.  
To indicate color, insert color code into part # blank.



## Rosettes & Screws

Part #	Carton Qty.	Master Ctn.
012-RW50 (Rosette/White)	50	500
012-RW500 (Rosette/White)	500	5M
012-RTW500 (Screw/White)	500	5M
012-RTCR100 (Rosette & Screw-CL)	100	1M
012-RTWR100 (Rosette & Screw-WH)	100	1M
012-RTWR200 (Rosette & Screw-WH)	200	2M



## Screws

### Unslotted Hex Washer Head - Aluminum

Part #	Ctn. Qty.	Mstr. Ctn.
012-ALU400 8 x 1-1/4	400	4M



### Specialty Screws

Part #	Ctn. Qty.	Mstr. Ctn.	Finish
<b>Phillips Screw - Flat Head</b>			
012-FPH50AB 6 x 5/8	50		Ant. Brass

#### Deck Screws

012-GALV 8 x 2-1/2	1.5M
--------------------	------

#### Hex Head Lag Screws with Washers

012-LW25 3/8 x 4	25	250
012-LW25 3/8 x 5	25	250
012-LW25 3/8 x 6	25	250
012-LW25 3/8 x 7	25	250

#### Hex Head Lag Screws - Raw

012-LB 3/8 x 4	600
012-LB 3/8 x 5	300
012-LB 3/8 x 6	300

#### Flat Washers (3/8") - Zinc

012-Washers-Bulk	50#	
012-Washers	50	500

#### Flat Washers (2") - Zinc

012-Washers 2"	50	500
----------------	----	-----



### Oval Head Phillips Screws - Bronze

Part #	Ctn. Qty.	Finish
012-PHBZ500 6 x 5/8	500	Bronze
012-PHBZ100 6 x 5/8	100	Bronze



Oval Head Phillips Screws

### Rumble Buttons

Part #	Ctn. Qty.	Mstr. Ctn.
012-RBB 10 x 1-1/8	2M	-
012-RB500 10 x 1-1/8	500	5M
012-RB250 10x 1-1/8	250	2.5M
012-RB100 10 x 1-1/8	100	1M
012-RB50 10x 1-1/8	50	500

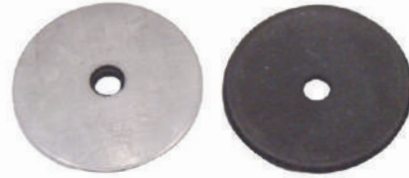



## Mouldings - Aluminum & Polymer

### End Cap

021-39201	Polar White
021-39202	Black
021-39203	Mill
021-39204	Colonial White

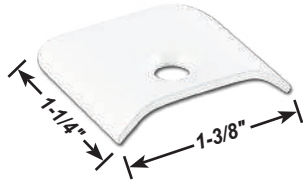

### Standard Awning Rail

021-50801-8	Polar White - 8'
021-50801-16	Polar White - 16'
021-50802-8	Black - 8'
021-50802-16	Black - 16'
021-50803-8	Mill - 8'
021-50803-16	Mill - 16'
021-50804-8	Colonial White - 8'
021-50804-16	Colonial White - 16'

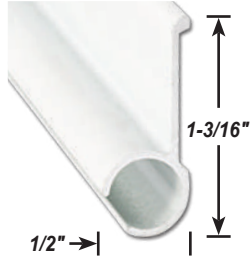

### Insert Awning Rail

021-51001-8	Polar White - 8'
021-51001-16	Polar White - 16'
021-51002-8	Black - 8'
021-51002-16	Black - 16'
021-51003-8	Mill - 8'
021-51003-16	Mill - 16'
021-51004-8	Colonial White - 8'
021-51004-16	Colonial White - 16'

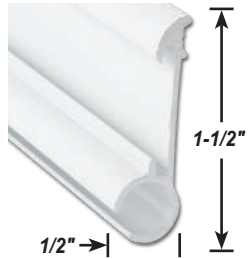

### Non Insert Roof Rim

021-51101-8	Polar White - 8'
021-51101-16	Polar White - 16'
021-51102-8	Black - 8'
021-51102-16	Black - 16'
021-51103-8	Mill - 8'
021-51103-16	Mill - 16'

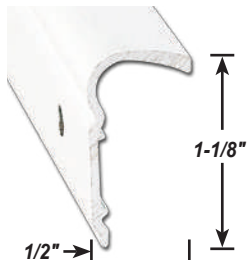

### Insert Base Trim

021-58203-6	Mill - 6'
021-58203-12	Mill - 12'

**NEW PRODUCT!**

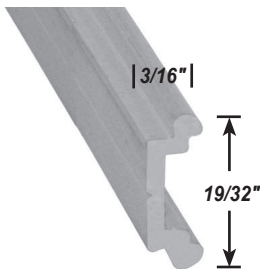

### Insert Moulding Trim

021-56401-8	Polar White - 8'
021-56401-16	Polar White - 16'
021-56402-8	Black - 8'
021-56402-16	Black - 16'
021-56403-8	Mill - 8'
021-56403-16	Mill - 16'



### Short Lip Insert

021-51601-8	Polar White - 8'
021-51601-16	Polar White - 16'
021-51602-8	Black - 8'
021-51602-16	Black - 16'
021-51603-8	Mill - 8'
021-51603-16	Mill - 16'

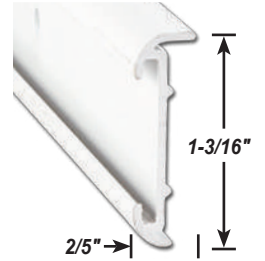

### Flat Trim w/Insert Track

021-54601-8	Polar White - 8'
021-54601-16	Polar White - 16'
021-54602-8	Black - 8'
021-54602-16	Black - 16'
021-54603-8	Mill - 8'
021-54603-16	Mill - 16'

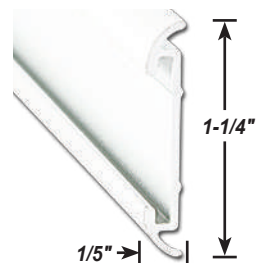

### Insert Gutter Rail

021-56201-8	Polar White - 8'
021-56201-16	Polar White - 16'
021-56202-8	Black - 8'
021-56202-16	Black - 16'
021-56203-8	Mill - 8'
021-56203-16	Mill - 16'

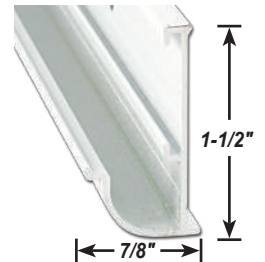

### Insert Gutter Rail

021-56301-8	Polar White - 8'
021-56301-16	Polar White - 16'
021-56302-8	Black - 8'
021-56302-16	Black - 16'
021-56303-8	Mill - 8'
021-56303-16	Mill - 16'
021-56304-8	Mill - 8'
021-56304-16	Mill - 16'

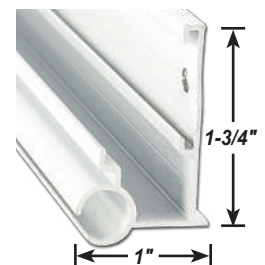

### Gutter Rail

021-323202-7	Black - 7'
021-323202-14	Black - 14'

**NEW PRODUCT!**

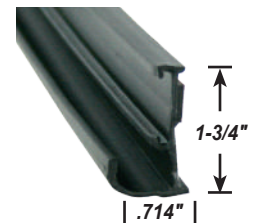

### Seam Binder

021-59803-14	Mill - 14'
--------------	------------

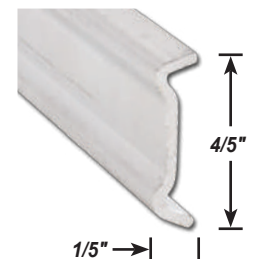

## Mouldings - Aluminum & Polymer

### Insert Roof Edge

021-57401-8	Polar White - 8'
021-57401-16	Polar White - 16'
021-57402-8	Black - 8'
021-57402-16	Black - 16'
021-57403-8	Mill - 8'
021-57403-16	Mill - 16'
021-57404-8	Colonial White - 8'
021-57404-16	Colonial White - 16'

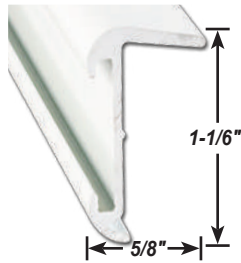

### Short Leg Non Insert Trim

021-86001-8	Polar White - 8'
021-86001-16	Polar White - 16'
021-86002-8	Black - 8'
021-86002-16	Black - 16'
021-86003-8	Mill - 8'
021-86003-16	Mill - 16'
021-86004-8	Colonial White - 8'
021-86004-16	Colonial White - 16'

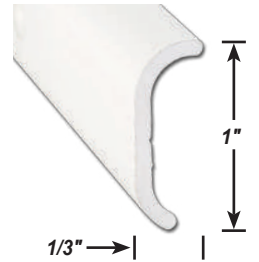

### Insert Corner Moulding

021-85001-8	Polar White - 8'
021-85001-16	Polar White - 16'
021-85002-8	Black - 8'
021-85002-16	Black - 16'
021-85003-8	Mill - 8'
021-85003-16	Mill - 16'
021-85004-8	Colonial White - 8'
021-85004-16	Colonial White - 16'

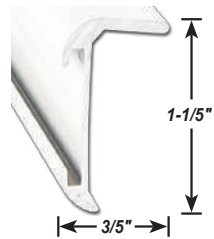

### Long Leg Non Insert Trim

021-86101-8	Polar White - 8'
021-86101-16	Polar White - 16'
021-86102-8	Black - 8'
021-86102-16	Black - 16'

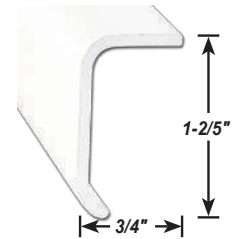

### Long Leg Insert Corner Moulding

021-85201-8	Polar White - 8'
021-85201-16	Polar White - 16'
021-85202-8	Black - 8'
021-85202-16	Black - 16'
021-85203-8	Mill - 8'
021-85203-16	Mill - 16'

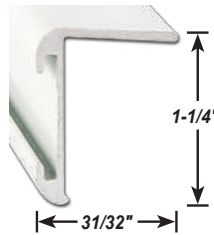

### Non Insert Flat Trim

021-87201-8	Polar White - 8'
021-87201-16	Polar White - 16'
021-87202-8	Black - 8'
021-87202-16	Black - 16'
021-87203-8	Mill - 8'
021-87203-16	Mill - 16'

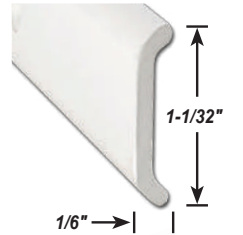

### Drip Rail

021-80201-8	White - 8'
021-80201-16	White - 16'

**NEW PRODUCT!**

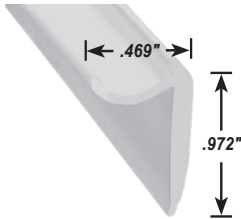

### Drip Rail

021-50102-8	Mill - 8'
021-50102-16	Mill - 16'

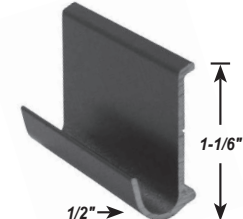

### Insert Base Trim

021-312502-8	Black - 8'
021-312502-16	Black - 16'

**NEW PRODUCT!**

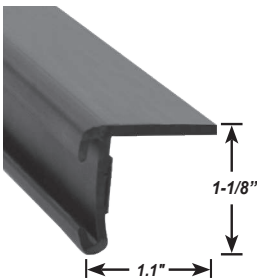

### Insert Corner Moulding

021-315102-8	Black - 8'
021-315102-16	Black - 16'

**NEW PRODUCT!**

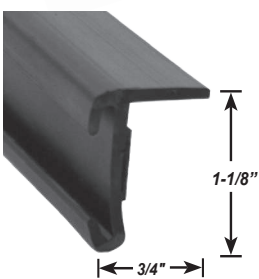

### 2x2 Angle

021-324602-6.375	Black - 6.375'
021-324602-12.75	Black - 12.75'

**NEW PRODUCT!**

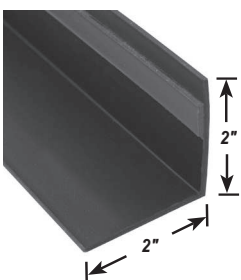

Each extrusion individually sleeved. 5 pieces shipped in tube.

**NEW PRODUCT!**

# RV Adapters & Extension Cords

## E-ZEE GRIP



**15 AMP**

**30 AMP**

**50 AMP**

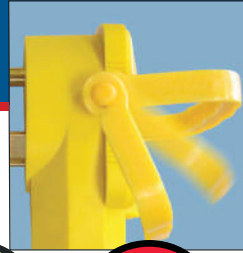

### Offering the Smart Choice

- ▶ UL and cUL approvals for a product you can trust
- ▶ Ergonomic Design Allows for Easier Grip
- ▶ Replaceable Nylon Handle
- ▶ Handle Folds Down to Fit Flush with Electrical Enclosures

AP Product's quality RV components with innovative features makes using your RV power cords and adapters easier to use! Our handle is large and ergonomic for a comfortable grip, and is replaceable. The handle sits flat into junction boxes enabling it to close completely for safety.



### 15-30 AMP Adapter

Item PN#	Cord Length	Wire Gauge	Wire Type	Wire Color	Outlets	Plug Type	Receptacle Type	Power Rating Amps	Watts	Pack Qty.
16-00502	12in	10/3	STW	Blue/Yellow	1	5-15	TT-30	15	1875	10



### 15-30 AMP Adapter

Item PN#	Cord Length	Wire Gauge	Wire Type	Wire Color	Outlets	Plug Type	Receptacle Type	Power Rating Amps	Watts	Pack Qty.
16-00502	12in	10/3	STW	Blue/Yellow	1	5-15P	30A	15	1875	10



### 30-50 AMP Adapter

Item PN#	Cord Length	Wire	Wire Type	Wire Color	Outlets	Plug Type	Receptacle Type	Power Rating Amps	Watts	Pack Qty.
16-00504	18in	10/3	STW	Blue/Yellow	1	TT-30	14-50	30	3750	10



### 50-30 AMP Adapter

Item PN#	Cord Length	Wire Gauge	Wire Type	Wire Color	Outlets	Plug Type	Receptacle Type	Power Rating Amps	Watts	Pack Qty.
16-00505	18in	10/3	STW	Blue/Yellow	1	14-50	TT-30	30	3750	10



16-00506



16-00526

### 30 AMP Generator Adapter

Item PN#	Cord Length	Wire Gauge	Wire Type	Wire Color	Outlets	Plug Type	Receptacle Type	Power Rating Amps	Watts	Pack Qty.
16-00506	18in	10/3	STW	Blue/Yellow	1	L5-30	TT-30	30	3750	10
16-00526	18in	10/3	STW	Blue/Yellow	1	L14-30	TT-30	30	3750	10



# RV Adapters & Extension Cords



## 30 AMP RV Extension Cord



Item PN#	Cord Length	Wire	Wire Type	Wire Color	Outlets	Plug Type	Receptacle Type	Power Rating Amps Watts	Pack Qty.
16-00507	15ft	10/3	STW	Blue/Yellow	1	TT-30	TT-30	30 3750	4
16-00508	25ft	10/3	STW	Blue/Yellow	1	TT-30	TT-30	30 3750	2
16-00509	50ft	10/3	STW	Blue/Yellow	1	TT-30	TT-30	30 3750	1



## 50 AMP RV Extension Cord



Item PN#	Cord Length	Wire Gauge	Wire Type	Wire Color	Outlets	Plug Type	Receptacle Type	Power Rating Amps Watts	Pack Qty.
16-00510	15ft	6/3-8/1	STW	Blue/Yellow	1	14-50	14-50	50 12500	2
16-00511	30ft	6/3-8/1	STW	Blue/Yellow	1	14-50	14-50	50 12500	1



## RV Locking Extension Cords

### RV Extension Cord with Locking Tight Female Receptacle



Item PN#	Cord Length	Wire Gauge	Wire Type	Wire Color	Outlets	Plug Type	Receptacle Type	Pack Qty.
16-00584	25ft	10/3	STW	Blue/Yellow	1	TT-30	L5-30	2
16-00585	35ft	10/3	STW	Blue/Yellow	1	TT-30	L5-30	2
16-00586	25ft	6/3-8/1	STW	Blue/Yellow	1	14-50	SS2-50	2
16-00587	35ft	6/3-8/1	STW	Blue/Yellow	1	14-50	SS2-50	2

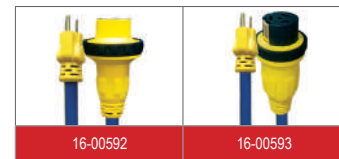

### RV Conversion Cords with Locking Tight Female Receptacle

16-00588	25ft	10/3	STW	Blue/Yellow	1	TT-30	SS2-50	2
16-00589	25ft	10/3	STW	Blue/Yellow	1	14-50	L5-30	2

## RV Locking Adapters

### RV Adapters with Locking Tight Female Receptacle

16-00590	2ft	10/3	STW	Blue/Yellow	1	TT-30	L5-30	10
16-00591	2ft	10/3	STW	Blue/Yellow	1	TT-30	SS2-50	10
16-00592	2ft	10/3	STW	Blue/Yellow	1	5-15	L5-30	10
16-00593	2ft	10/3	STW	Blue/Yellow	1	5-15	SS2-50	10

### Replacement Handle



## RV Locking Molded Adapters

### Heavy Duty Molded Adapters

Item PN#	Outlets	Plug Type	Receptacle Type	Pack Qty.
16-00594	1	5-15	L5-30	10
16-00595	1	TT30	L5-30	10
16-00596	1	5-15	SS2-50	10
16-00597	1	TT30	SS2-50	10





# RV Adapters & Extension Cords

AP Products manufactures a full line of RV products, from molded adapters and cords to inverters and generator adapters. The E-ZEEGRIP® series offers a premium product to customers with ungraded features at a great price. Our point of purchase displays and NEW E-ZEEGRIP® set make marketing easy! This year, we introduce our new line of RV locking products with the patented E-ZEEGRIP® handle.

## Park Adapters

Item PN#	Outlets	Plug Type	Receptacle Type	Pack Qty.
16-00500	1	5-15	TT-30	10/100
16-00501	1	TT-30	5-15	10/100
16-00550	1	5-15	TT-30	10/100
16-00551	1	TT-30	5-15	10/100



## Park Generator Adapter

16-00516	1	L5-30	TT-30	10/50
16-00517	1	L14-30	TT-30	10/50

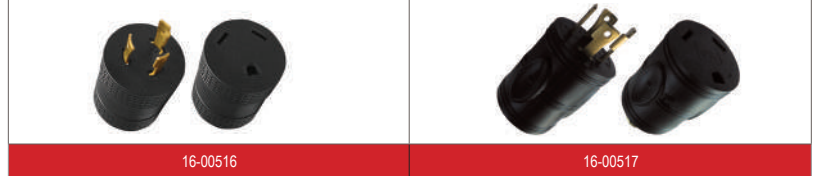

## Heavy Duty Molded Adapters

Item PN#	Outlets	Plug Type	Receptacle Type	Pack Qty.
16-00582	1	TT-30	14-50	10/50
16-00583	1	14-50	TT-30	10/50

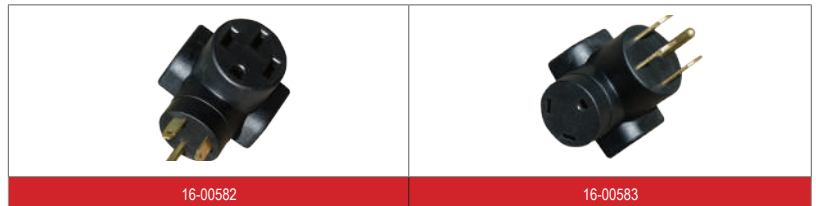

## 30 & 50 AMP Replacement Heads



Item PN#	Description	Pack Qty.
16-00580	Male TT-30 Replacement Head	10/50
16-00581	Female TT-30 Replacement Head	10/50
16-00578	Male 14-50 Replacement Head	10/50
16-00579	Female 14-50 Replacement Head	10/50



## Flat Wire Adapters

Item PN#	Cord Length	Gauge	Plug Type	Receptacle Type	Pack Qty.
16-00568	12in	10/3	5-15	TT-30	10
16-00569	12in	10/3	TT-30	5-15	10
16-00570	18in	10/3	TT-30	14-50	10
16-00571	18in	10/3	14-50	TT-30	10



# RV Adapters & Extension Cords



15-30 AMP Adapter											
Item PN#	Cord Length	Wire Gauge	Wire Type	Wire Color	Outlets	Plug Type	Receptacle Type	Power Rating	Amps	Watts	Pack Qty.
16-00552	12in	10/3	STW	Black	1	5-15	TT-30	15	1875		10



30-15 AMP Adapter											
Item PN#	Cord Length	Wire Gauge	Wire Type	Wire Color	Outlets	Plug Type	Receptacle Type	Power Rating	Amps	Watts	Pack Qty.
16-00553	12in	10/3	STW	Black	1	TT-30	5-15	15	1875		10



30-50 AMP Adapter											
Item PN#	Cord Length	Wire Gauge	Wire Type	Wire Color	Outlets	Plug Type	Receptacle Type	Power Rating	Amps	Watts	Pack Qty.
16-00554	18in	10/3	STW	Black	1	TT-30	14-50	15	3750		10



50-30 AMP Adapter											
Item PN#	Cord Length	Wire Gauge	Wire Type	Wire Color	Outlets	Plug Type	Receptacle Type	Power Rating	Amps	Watts	Pack Qty.
16-00555	18in	10/3	STW	Black	1	14-50	TT-30	15	3750		10



30 AMP and 50 Amp RV Extension Cord											
Item PN#	Cord Length	Wire Gauge	Wire Type	Wire Color	Outlets	Plug Type	Receptacle Type	Power Rating	Amps	Watts	Pack Qty.
16-00557	10ft	10/3	STW	Black	1	TT-30	TT-30		3750		4
16-00558	25ft	10/3	STW	Black	1	TT-30	TT-30		3750		2
16-00559	50ft	10/3	STW	Black	1	TT-30	TT-30		3750		1
16-00561	30ft	6/3	STW	Black	1	14-50	14-50		12500		2



30 AMP Right Angle Power Supply Cord											
Item PN#	Cord Length	Wire Gauge	Wire Type	Wire Color	Outlets	Plug Type	Receptacle Type	Power Rating	Amps	Watts	Pack Qty.
16-00562	25ft	10/3	STW	Black	1	TT-30	-	30	3750		2
16-00566	35ft	10/3	STW	Black	1	TT-30	-	30	3750		2



50 AMP Right Angle Power Supply Cord											
Item PN#	Cord Length	Wire Gauge	Wire Type	Wire Color	Outlets	Plug Type	Receptacle Type	Power Rating	Amps	Watts	Pack Qty.
16-00563	30ft	6/3	STW	Black	1	14-50	-	50	12500		2



30 AMP Right Angle Male and Female Pigtail											
Item PN#	Cord Length	Wire Gauge	Wire Type	Wire Color	Outlets	Plug Type	Receptacle Type	Power Rating	Amps	Watts	Pack Qty.
16-00564	18in	10/3	STW	Black	1	TT-30M	-	30	3750		10
16-00565	18in	10/3	STW	Black	1	TT-30F	-	30	3750		10