

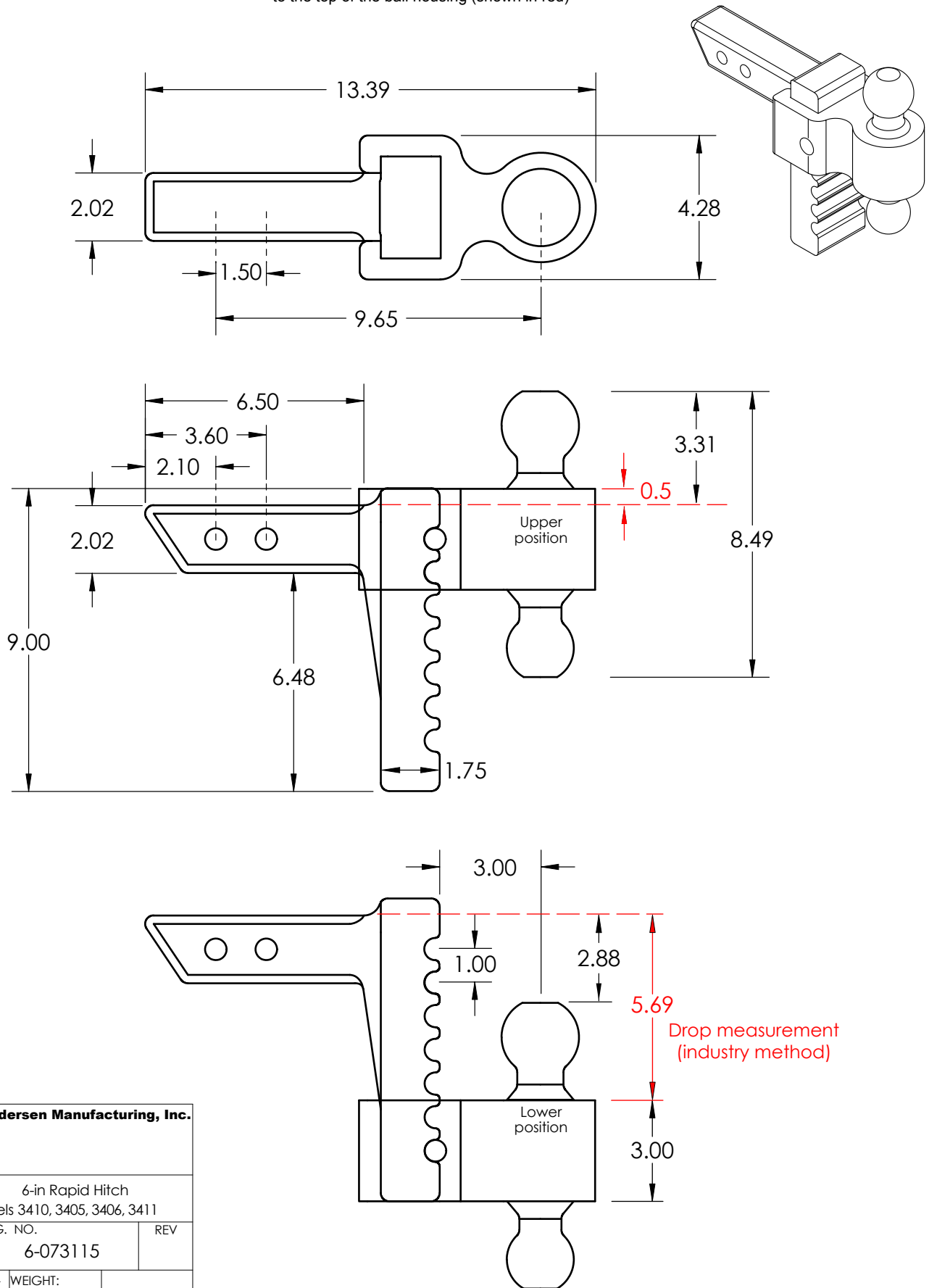

Andersen Hitches 6-inch Rapid Hitch 3410, 3405, 3406, 3411

Note: For all hitch manufacturers, the 'drop' is measured from the top of the receiver bar to the top of the ball housing (shown in red)



 Andersen Manufacturing, Inc.		
TITLE: 6-in Rapid Hitch Models 3410, 3405, 3406, 3411		
SIZE	DWG. NO.	REV
A	6-073115	
SCALE: 1:4	WEIGHT:	