

ASSEMBLY & INSTALLATION GUIDE

AMP RESEARCH **BedXTender HD™**

MADE IN USA

APPLICATION

Jeep Gladiator

PART

74833-01A(Black)

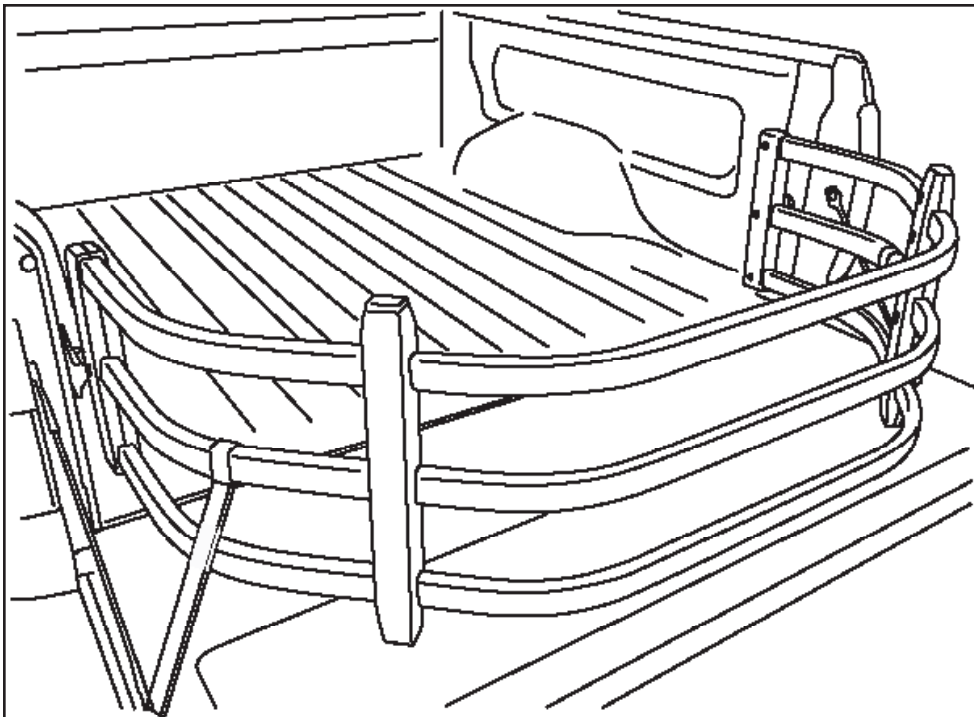

BEDXTENDER HD™ shown assembled and installed on truck.

Remove contents from box and check for damage.
Verify all parts against parts list.
Read and understand instructions completely before attempting assembly and installation.

INSTALLATION TIME

1 Hour

SKILL LEVEL



1= Easy

TOOLS REQUIRED

Phillips screw driver
Torx T-25 driver
Power drill
9/64" drill bit
Center punch
Supplied templates
Soapy Water

Invented, engineered and manufactured exclusively by AMP Research in the USA. May be covered by one of the following patents:

5,700,047; 6,113,173; 6,402,215; 6,805,392; 7,063,366; 7,393,035; 7,654,598; 7,681,935; 7,841,638

PARTS LIST AND HARDWARE IDENTIFICATION

① x2

Quick Mount
Bracket Set

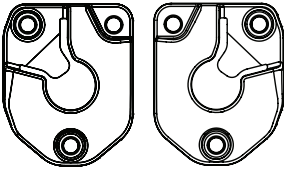

② x6

Phillips head
screw
(included in 74608-01A)

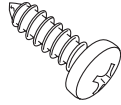

③ x12

PT-Screw

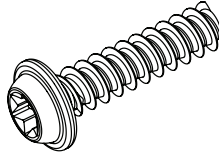

④ x4

Bumper

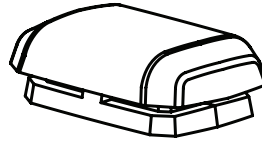

⑤ x2

Strap Buckle Assembly

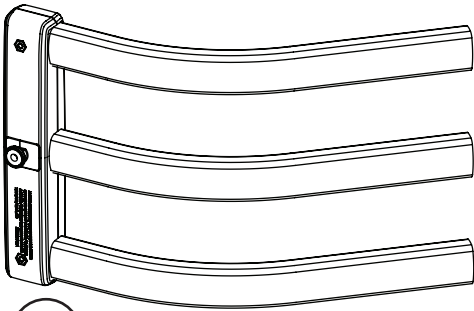

⑥ x2

Pivot Upright Assembly



⑦ x2

Bumper Upright Outer



⑧ x2

Bumper Upright Inner

⑨

Double Bend Center Tube (With AMP Logo)



⑩ x2

Double Bend Center Tube (Without AMP Logo)



UNIVERSAL MOUNTING BRACKET INSTALLATION

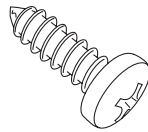
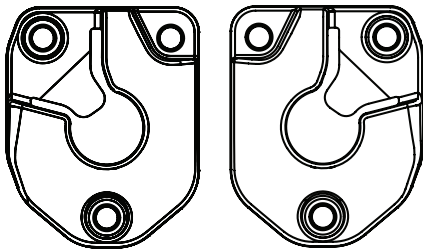

1 x2

Quick Mount
Bracket

2 x6

Phillips head
screw

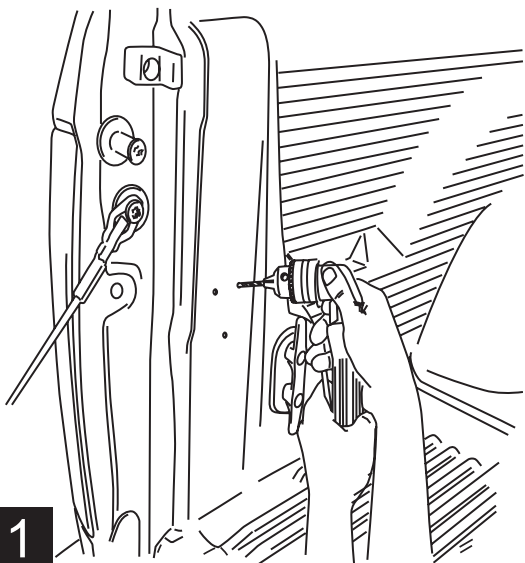

Using a power drill and 9/64" drill bit, drill through the existing dimple holes in sheet metal. If equipped with a bedliner, drill through bedliner.

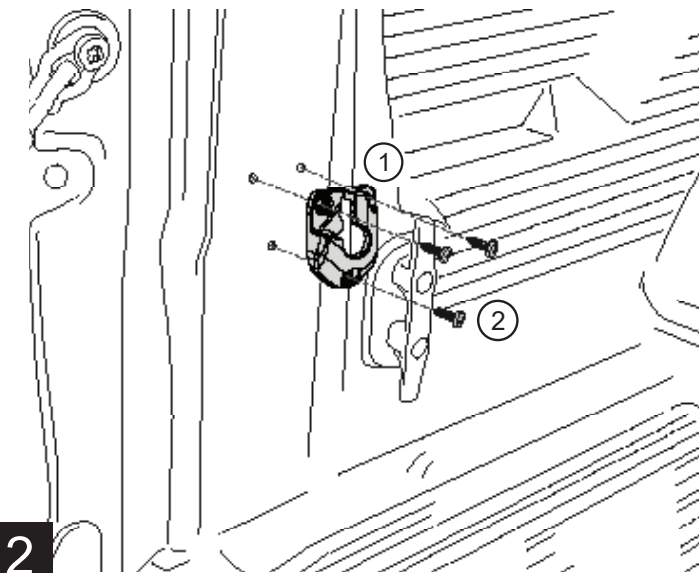

Fasten mounting brackets using the supplied self-tapping Phillips screws and torque to 30 in. lbs. If equipped with a bedliner, install mounting brackets over bedliner.

BED X-TENDER ASSEMBLY

Using template measure 7" from each end of the three long tubes and mark with tape. **Tape is to be used as a reference point.** (See step 6)

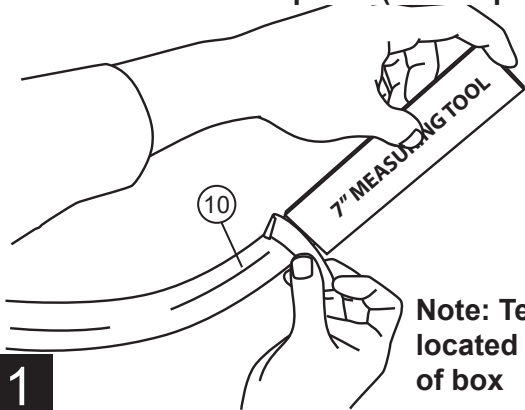

Note: Template located on inside of box

1

Slide the center tube (With Amp logo) into the center tube of the 3-tube assembly. **Be sure to slide on Strap Buckle Assembly to center tube of Pivot Upright Assembly**

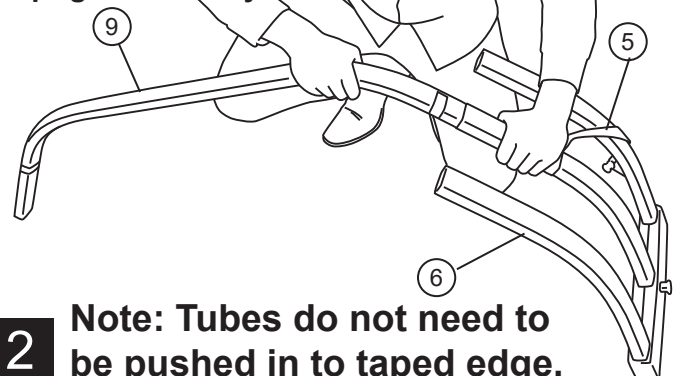

Note: Tubes do not need to be pushed in to taped edge.

2

Insert the top long tube into the top tube of the 3-tube assembly.

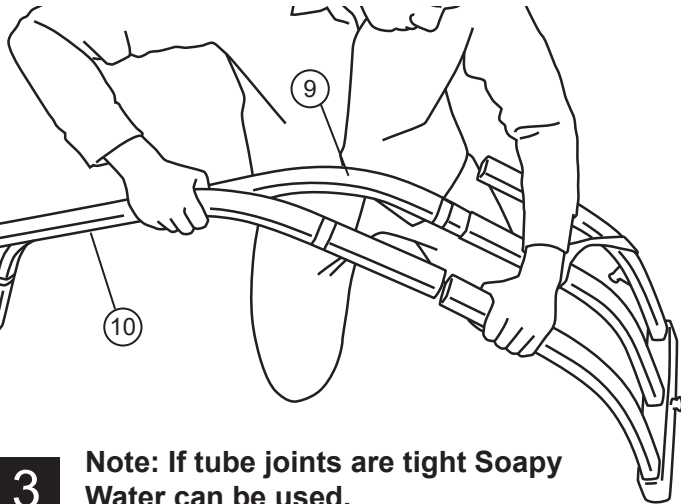

Note: If tube joints are tight Soapy Water can be used.

3

Insert the bottom long tube into the bottom tube of the 3-tube assembly.

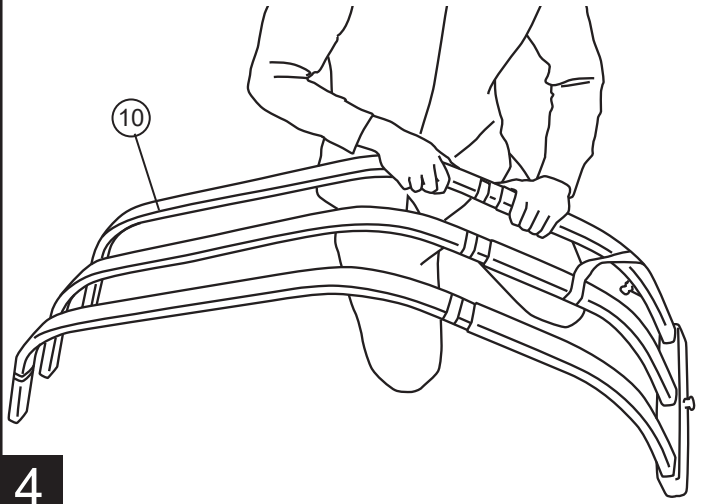

4

Repeat for the other side.

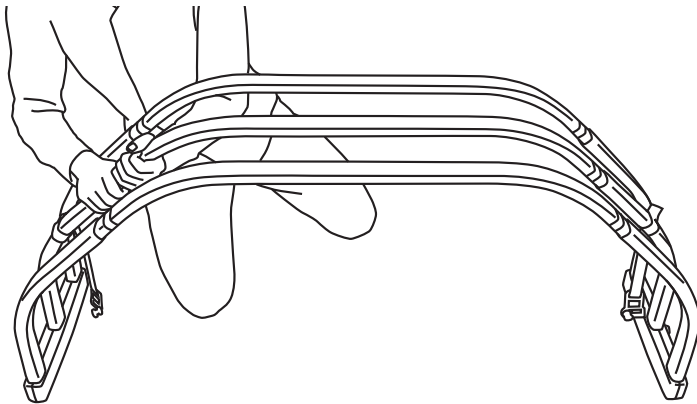

Note: Install Strap Buckle Assembly to center tube of Pivot Upright Assembly.

5

Adjust the width of the BEDXTENDER to fit the pre-installed mounting brackets. To keep tube overlap constant, adjust each tube so that the gap between the edge and the tape is the same.

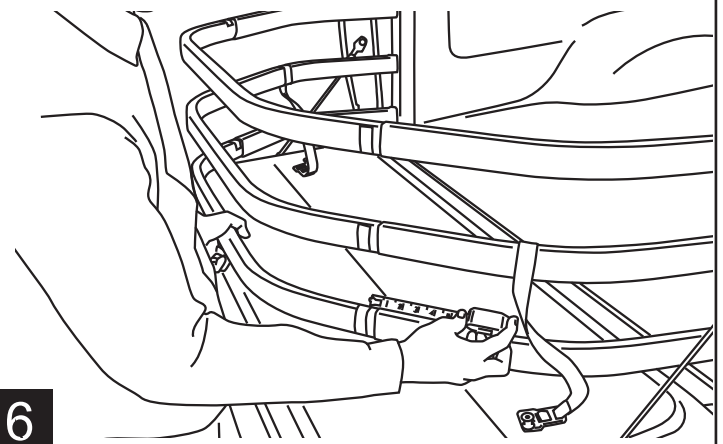

6

BED X-TENDER ASSEMBLY – CONTINUED

Attach plastic upright around the tube juncture, placing rubber bumpers into the two ends of the upright.

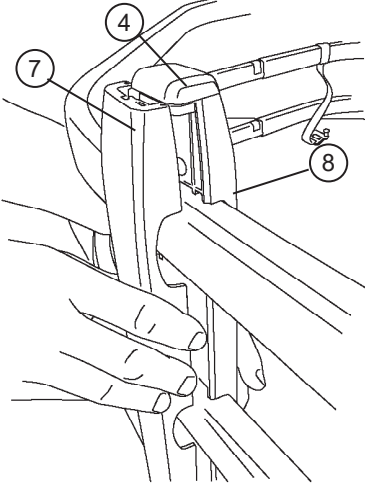

Upright is not positioned in center of tube joint.

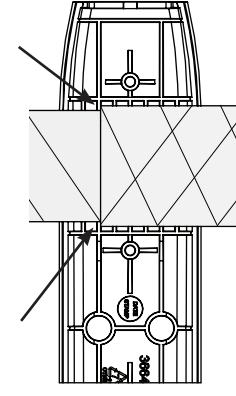

7 **NOTE:** The inside of the upright is stepped to fit correctly around the small and large diameter tubes.

Tighten PT-Screws using a T-25 torx driver, starting in the middle of each upright, then the outer screws and lastly the remaining two to evenly tighten.

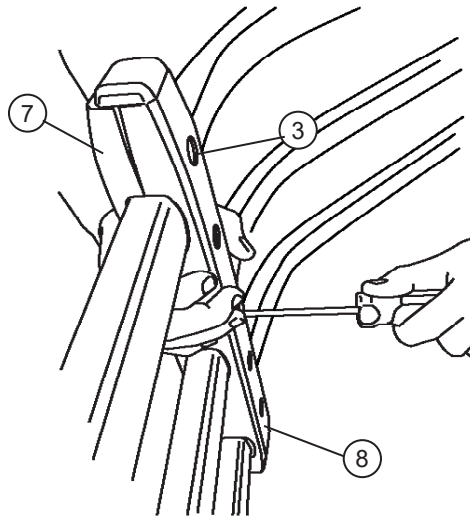

8 **NOTE:** Do not over tighten as this may strip out. Fastener will reach a noticeable stopping point.

Adjust Strap Buckles to lock into the tailgate when BEDXTENDER is deployed. Your assembly is now complete.

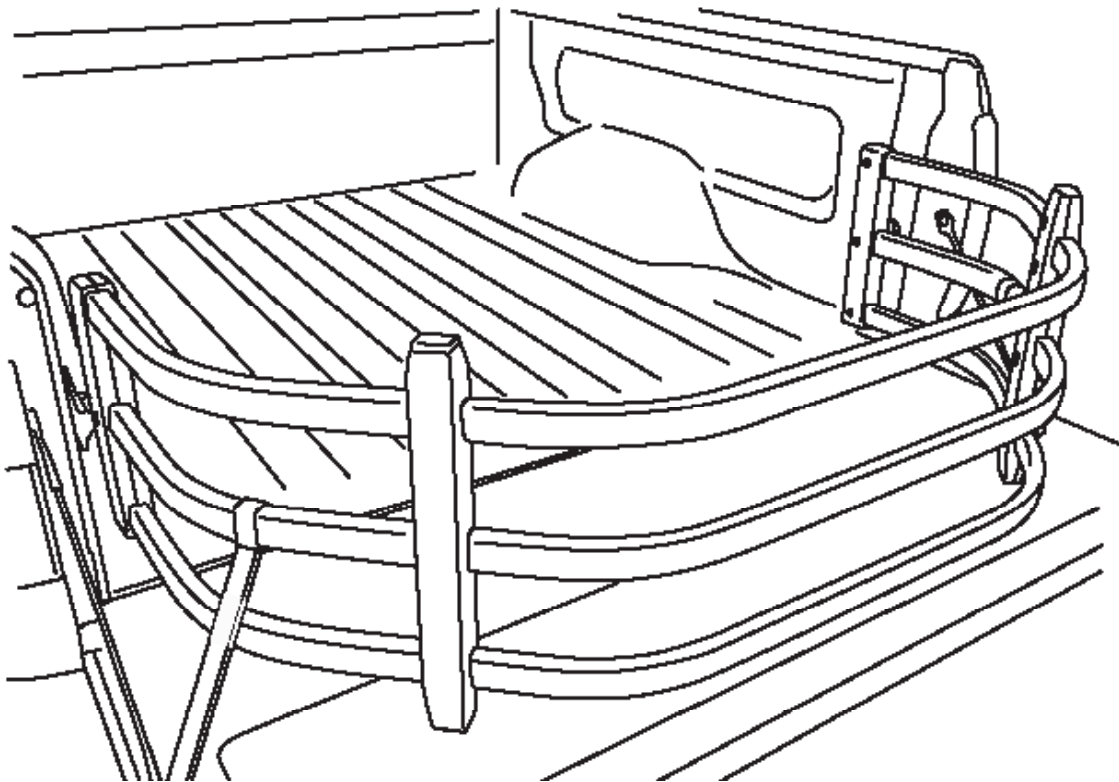

When the BEDXTENDER is at the furthest rear position, push down on the buckle to insert into tailgate latch. Tighten straps. To release, pull tailgate handle.

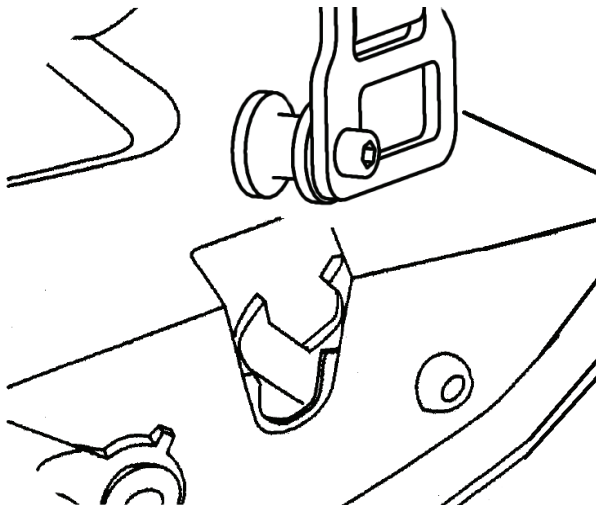

NOTE: Ensure that buckles are properly inserted into latches by pulling on the straps after both buckles have been inserted.



BEDXTENDER HD™ OPERATION

With the tailgate open, place BEDXTENDER pivot pins into the left and right mounting brackets. Rotate to 45 until it drops into place, then lower onto the open tailgate.



Flip BEDXTENDER out to contain cargo in the truck bed when the tailgate is open. CAUTION! 200lb maximum load on open tailgate. Always distribute cargo evenly and properly secure inside bed. Do not secure cargo to the BEDXTENDER or the tailgate.



Before driving, secure BEDXTENDER by locking the provided strap buckles into the truck's tailgate latches. To release, pull tailgate handle. NOTE: Ensure that both buckles are properly locked into the latches by pulling up on each strap.



Flip BEDXTENDER forward and close the tailgate to keep smaller cargo safe and organized.

WARNING

Be sure to read and precisely follow the provided instructions when installing this product. Failure to do so could place the vehicle occupants in a potentially dangerous situation. After installing or reinstalling, re-check to insure that the product is properly installed.



The material that your product is made from can be recycled. Please also consider recycling the packaging that your product came in.



Drill template for BEDXTENDER HD™ mounting brackets

NOTE: FOR TRUCKS WITH BEDLINERS, USE THIS TEMPLATE ON TOP OF BEDLINER. DO NOT CUT BEDLINER!

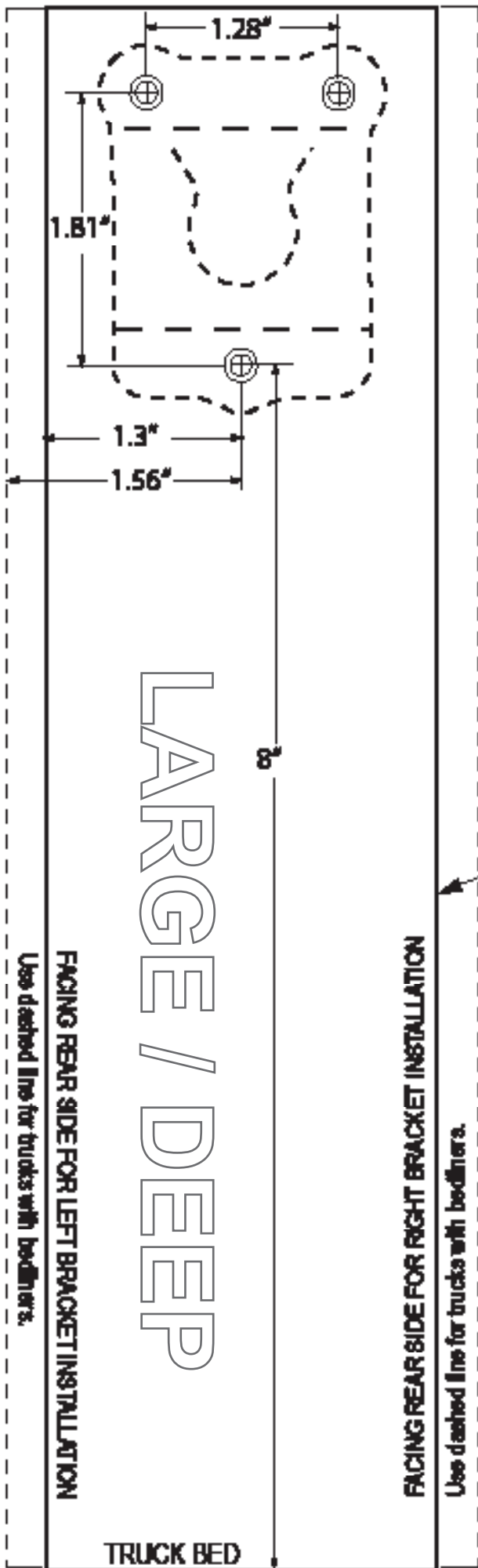

Drill template for BEDXTENDER HD™ mounting brackets

Cut or fold along solid lines.
(Dashed lines for trucks with bedliners.)

