



Installation instructions

Akrapovič Exhaust System:
Evolution line
for the
Porsche Cayenne S (type 536)

SAFETY AND COMPLIANCE WARNING, PLEASE READ CAREFULLY

BEFORE REMOVING THE STOCK EXHAUST SYSTEM AND BEGINNING THE INSTALLATION OF YOUR NEW AKRAPOVIČ EXHAUST, PLEASE MAKE SURE THAT ALL ITEMS LISTED BELOW ARE VERIFIED:

- This manual is specific to the car indicated on the cover page, for which it is designed. Installation procedures vary depending on the type of car. Please verify that the Akrapovič **exhaust system and this installation manual correspond to the type of your car.**
- The exhaust system can get extremely hot during and after it is used. Make sure not to touch the exhaust system until it is completely cool. **Allow the exhaust and engine to cool down before beginning installation.**
- Make sure the car is **securely positioned to prevent** damage to yourself and other, or the car.
- Please check the parts you received against the parts list available on our website. Make sure that you have **all the parts necessary for the installation** of your new Akrapovič exhaust system. If any of the parts is missing, please do not proceed with uninstalling your stock exhaust system/installing the Akrapovič exhaust system and contact the retailer where you purchased the Akrapovič exhaust system.
- Every exhaust system muffler has its unique serial number, which identifies the authenticity of the product. You can find the serial number on the muffler's sleeve. Please refer to the **picture 1** below. Please verify that your exhaust system is an original Akrapovič product. If you have any doubts, please contact the reseller where you purchased the exhaust system or Akrapovič partners. This manual, any certificates and Akrapovič warranty apply to original products only.

GENERAL NOTE

Photographs and other illustrations in this manual are symbolic and are intended to help represent individual steps for proper installation and use, as well as for a general overview. The actual component parts of the Akrapovič exhaust system may not entirely correspond to the photographs and other illustrations.

Picture 1 - Serial Number Position

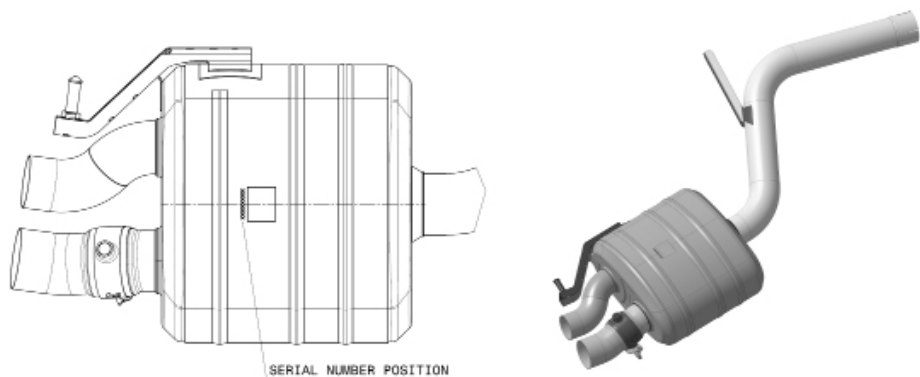

NOISE AND EMISSION WARNINGS

General warning

Because of the world-wide distribution of Akrapovič d.d. products, neither Akrapovič d.d. nor any of its subsidiaries make any representation that the exhaust system complies with the air and/or noise emissions laws, or labeling laws, of any jurisdiction. The purchasers are entirely responsible for informing themselves of the applicable laws where the products are to be used and to comply with those law.

Although legal compliance of Akrapovič products in a _____ country should be determined by the user, you can find some basic guidance on compliance of your Akrapovič exhaust system with various legal requirements on the product-related part of our website. For EC and ECE type approvals, please refer to the certificate enclosed to your product.

USA WARNING

Various U.S. states and the U.S. federal government have individual laws regulating the use of aftermarket exhaust parts and systems, especially as those parts and systems modify, remove, or replace original equipment catalysts. Please consult the appropriate laws in your area before installing any aftermarket part or system on your vehicle to ensure compliance with all applicable laws. Neither Akrapovic d.d. nor any of their subsidiaries or the sellers of the parts or systems make any representation that any of their parts or systems comply with any such laws.

CALIFORNIA WARNING

California laws prohibit the use of any aftermarket exhaust part or system that modifies, removes or replaces original equipment catalysts unless the California Air Resources Board has issued an Executive Order regarding such part or system or unless the part or system is exempted by being used only on racing vehicles on closed courses. Neither Akrapovic d.d. nor any of their subsidiaries make any representation that any of their parts or systems has received such an Executive Order or that any of their parts or systems conform with the racing vehicles exemption. The purchasers are entirely responsible for informing themselves of applicable California laws and to comply with those laws.

SYMBOLS

The following symbols are used throughout these installation instructions:



TOOLS AND PROTECTIVE EQUIPMENT REQUIRED



TIGHTENING TORQUE



LUBRICATION



HAND TIGHTEN



INSTALLATION TIP



CAUTION OR IMPORTANT

USE BOLT SEALANT

Apply 3 to 4 small drops of bolt sealant onto the cleaned and degreased threads before tightening the bolts.

WARNING! Avoid contact with skin, eyes and mucous membranes. Do not inhale fumes. Keep out of reach of children.



USE ANTI-SEIZE LEAD-FREE COPPER PASTE (black tube)

Provides trouble-free and long-lasting protection against seizing, corrosion and rusting of bolts, threaded ends, nuts, joints, etc. Also protects against vibration, wear and impact. **WARNING! Avoid eye contact. Keep out of reach of children.**



USE ANTI-SEIZING GREASE (white tube)

Prevents seizing, corrosion and excessive wear between the titanium components of your exhaust system. **WARNING! Avoid eye contact. Keep out of reach of children.**



Tools & equipment

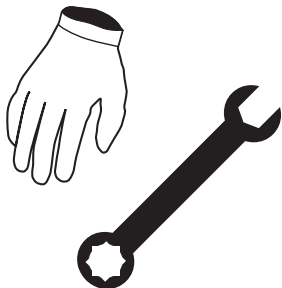

- mechanic gloves
- eye protection
- Torx 30
- Torx E12
- Torx XZN 8
- Socket 15 mm
- Socket 16 mm
- Socket 17 mm
- T-handle 10 mm wrench
- T-handle 13 mm swivelling wrench
- T-handle 6 mm three hexagon wrench
- Rubber bracket unhooking tool
- Small cross head screwdriver
- Cutting nippers

PARTS LIST

The following parts should be found in the box:

- Installation Manual
-
- Warranty
- Fitting material
- , pipes, Carbon Fiber components or Sound Kit components

IMPORTANT: The car should be in the off position throughout the dismantling and installation process, as well as any other work done on the exhaust system!

REMOVAL OF STOCK EXHAUST SYSTEM:

The process of uninstalling the original exhaust system may vary depending on the existing exhaust system. Please follow the original exhaust system manufacturer's instructions for uninstalling the original exhaust system.

If you for any reason decide otherwise, please note that any information provided in this respect herein should be considered as general information provided for your convenience only. Akrapovič shall not assume any liability or responsibility with regard to uninstalling your existing exhaust

In case your Akrapovič exhaust system may not be used on certain roads or under certain conditions, please keep the stock or other exhaust system that you can use in such circumstances legally.

REMOVAL OF STOCK EXHAUST SYSTEM:

Put the vehicle onto a car lift.

! **CAUTION:** ensure that the car is lifted safely and properly in order to avoid the risk of vehicle damage, injury, or even death!

1. Unscrew the marked bolts and carefully remove the panels on both sides of the vehicle (F 01, 02).

! **CAUTION:** make sure not to injure yourself or damage any part of the vehicle during this process!

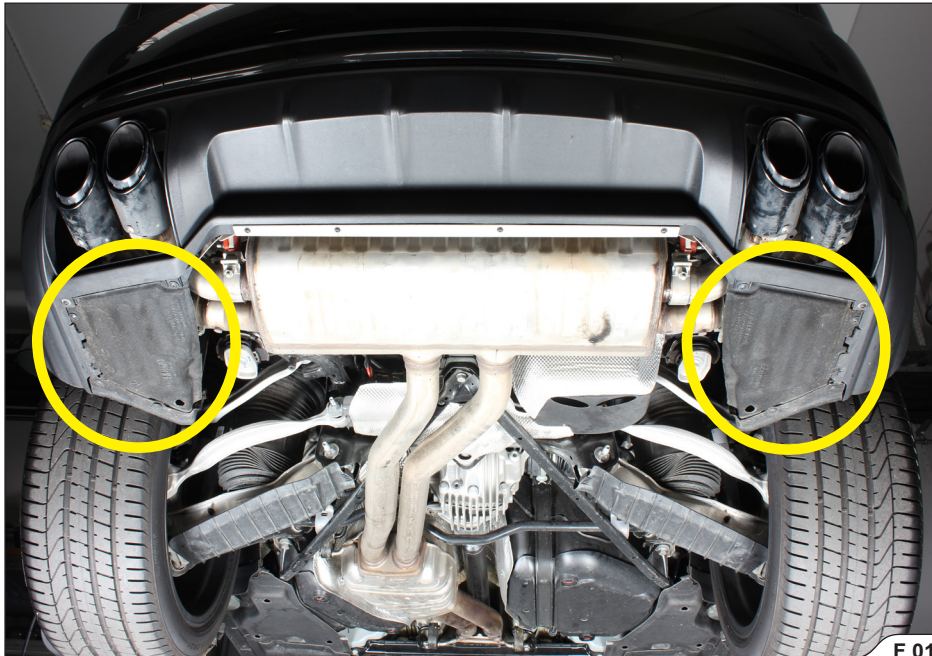

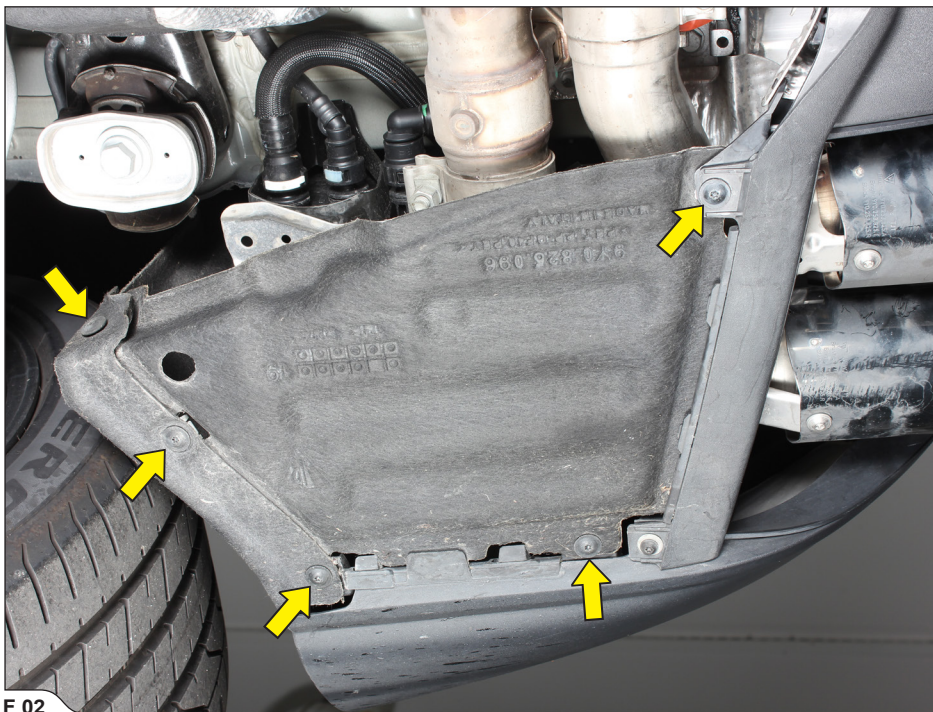

F 02

2. Loosen the marked clamps on both sides of the vehicle and carefully remove all tail pipes (F 03).
! **CAUTION:** make sure not to injure yourself or damage any part of the vehicle during this process!

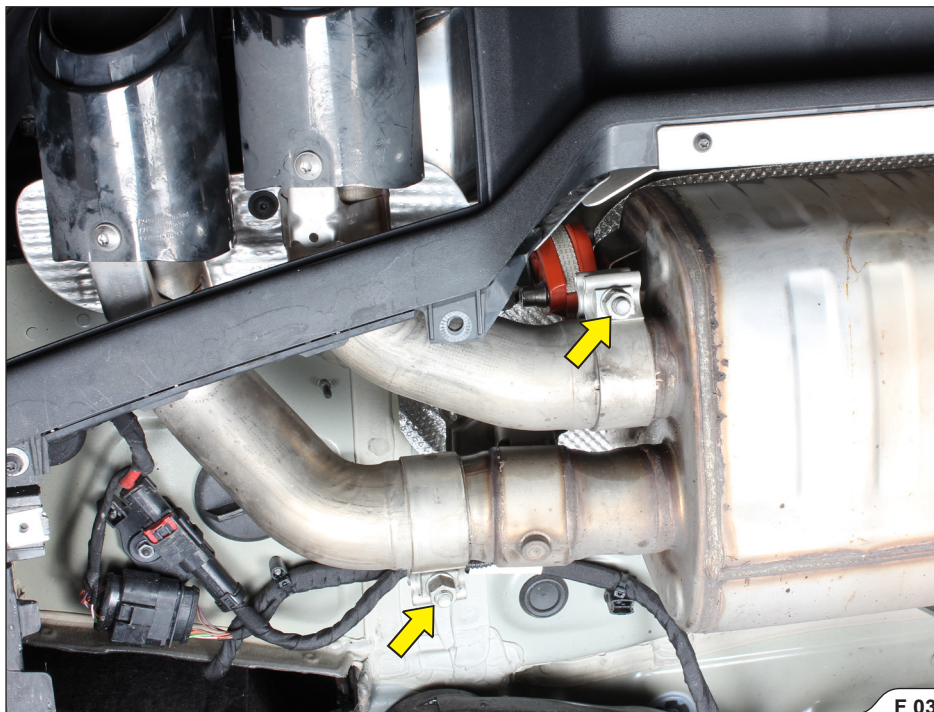

3. Unscrew the marked nuts and bolts, undo the plastic fasteners and remove the central under-
(F 04).

! CAUTION: make sure not to injure yourself or damage any part of the vehicle during this process!

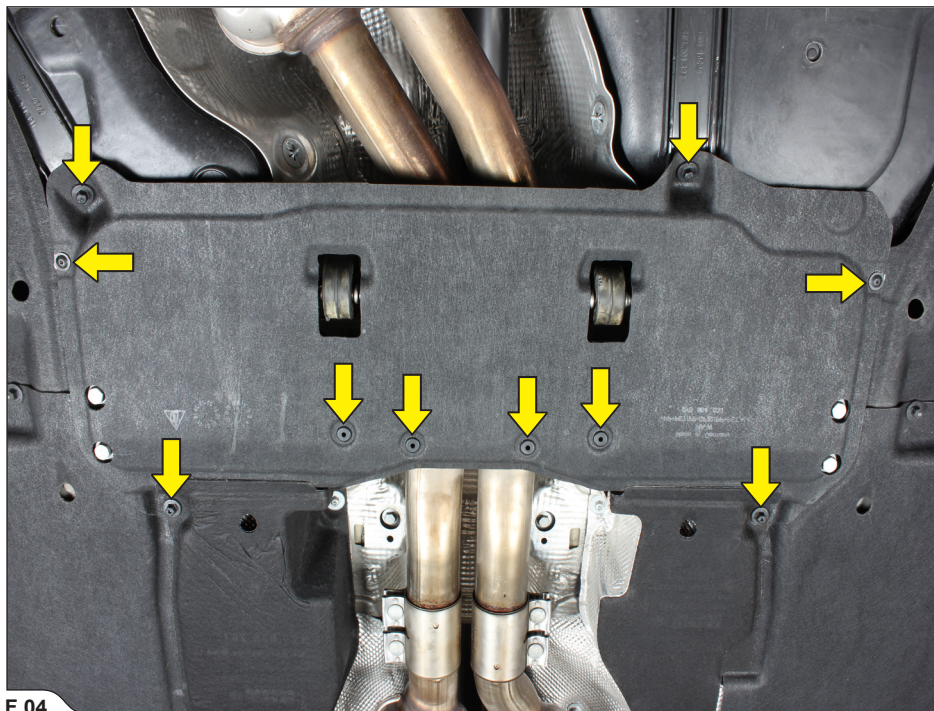

F 04

4. Unscrew the marked rubber brackets' bolts (F 05).

! CAUTION: make sure not to injure yourself or damage any part of the vehicle during this process!

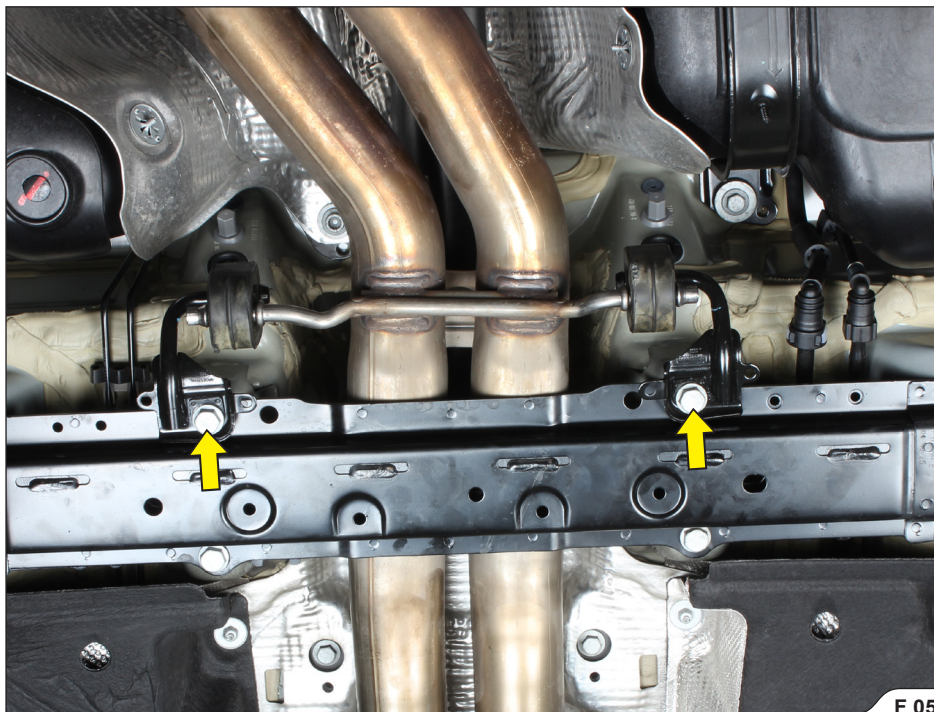

5. For vehicles with stock sport exhaust system only: disconnect the exhaust actuator(s) (F 06).

! CAUTION: make sure not to injure yourself or damage any part of the vehicle during this process!

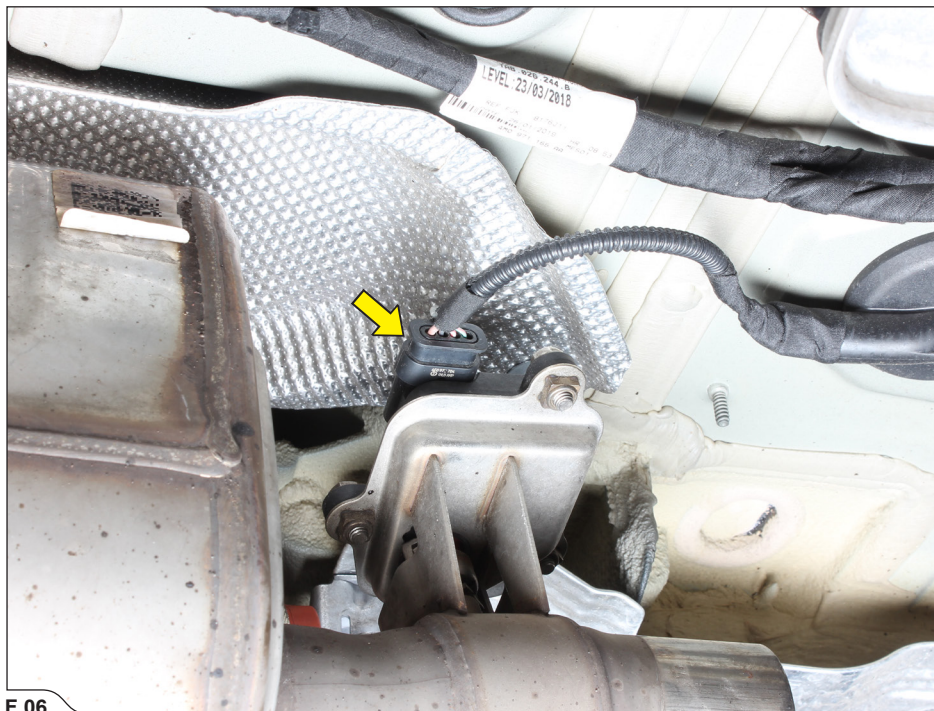

F 06

6. Support the exhaust system, undo the middle rubber bracket, unscrew both [unclear]'s rubber brackets (F 07, 08, 09).

! **INSTALLATION TIP:** for easier dismantling, lubricate the original rubber brackets (WD40®)*.

*WD-40® is a trademark of the WD-40 Company.

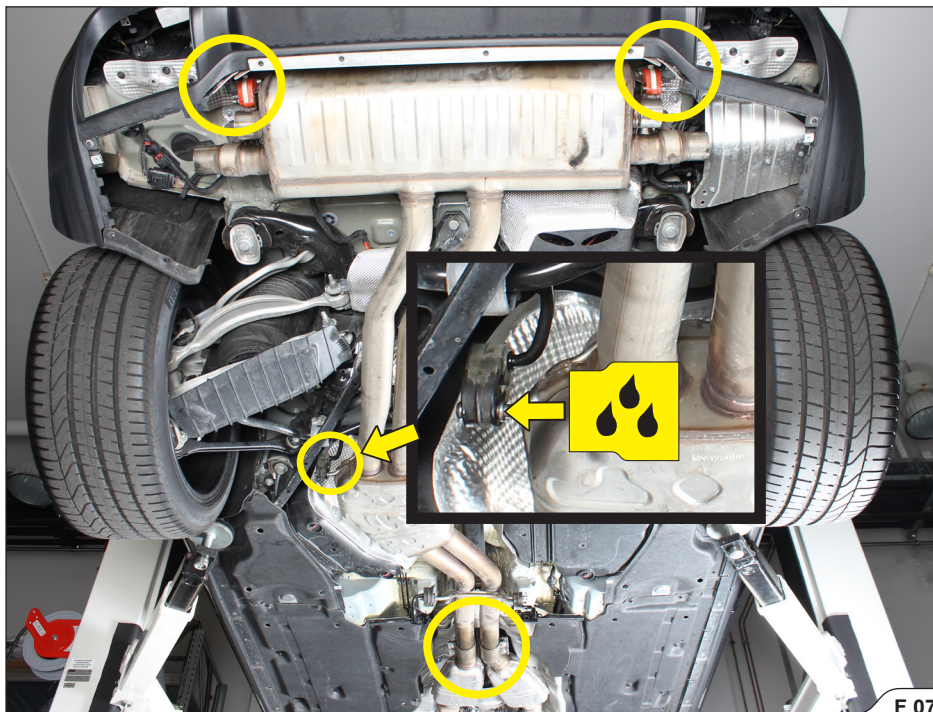



F 08

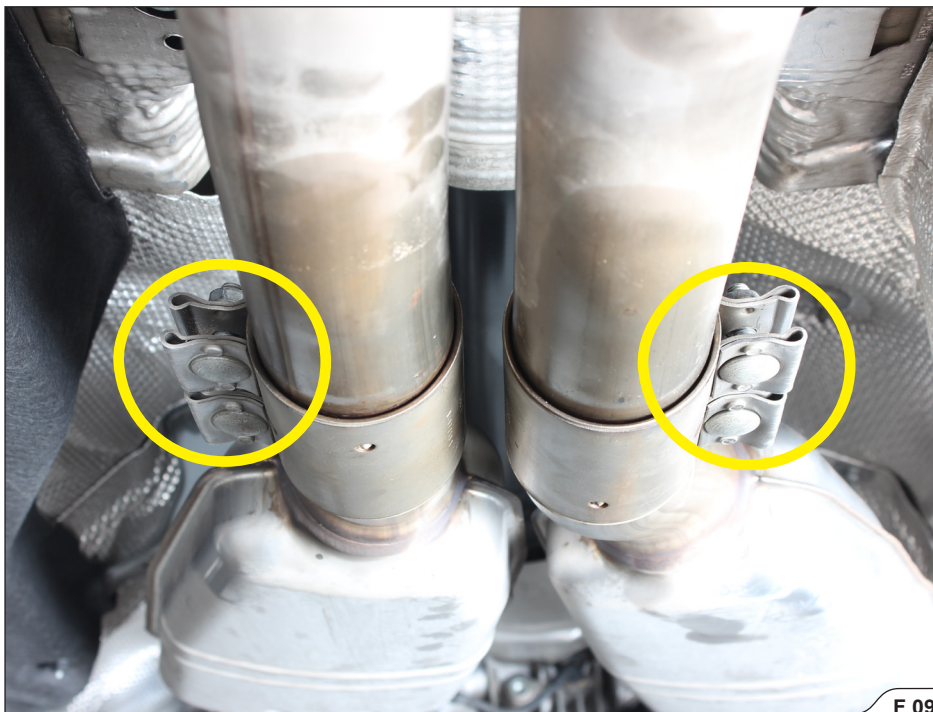

7.

(F 10).

! CAUTION: make sure not to injure yourself or damage any part of the vehicle during this process!

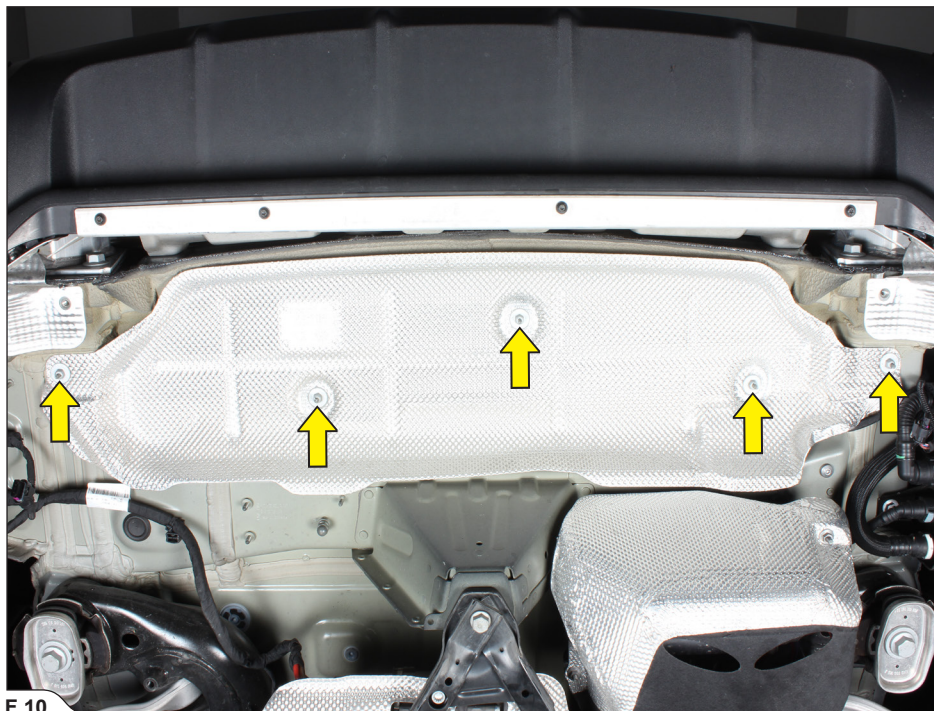

F 10

8. Remove the marked rubber grommet (F 11).

! **CAUTION:** make sure not to injure yourself or damage any part of the vehicle during this process!

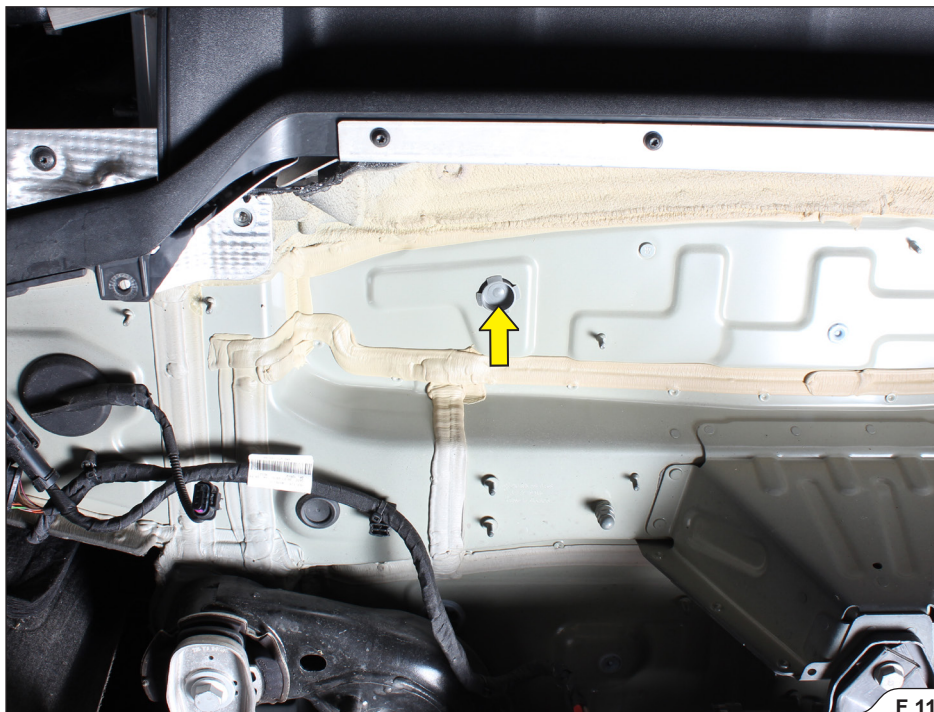

F 11

INSTALLATION OF THE AKRAPOVIČ EXHAUST SYSTEM:

1. Open the trunk and remove the trunk panel and left side trunk trim panels to get access to electrical wiring harness in the trunk; check vehicle manufacturer manual for correct trunk panels disassembly (F 12, 13, 14, 15, 16).

! CAUTION: make sure not to injure yourself or damage any part of the vehicle during this process!



F 12





F 14





F 16

- Carefully separate the marked **green** and **orange** wires from the stock harness - located on the left side of the trunk (F 17, 18).

! **IMPORTANT:** make sure not to damage the wires during this process!



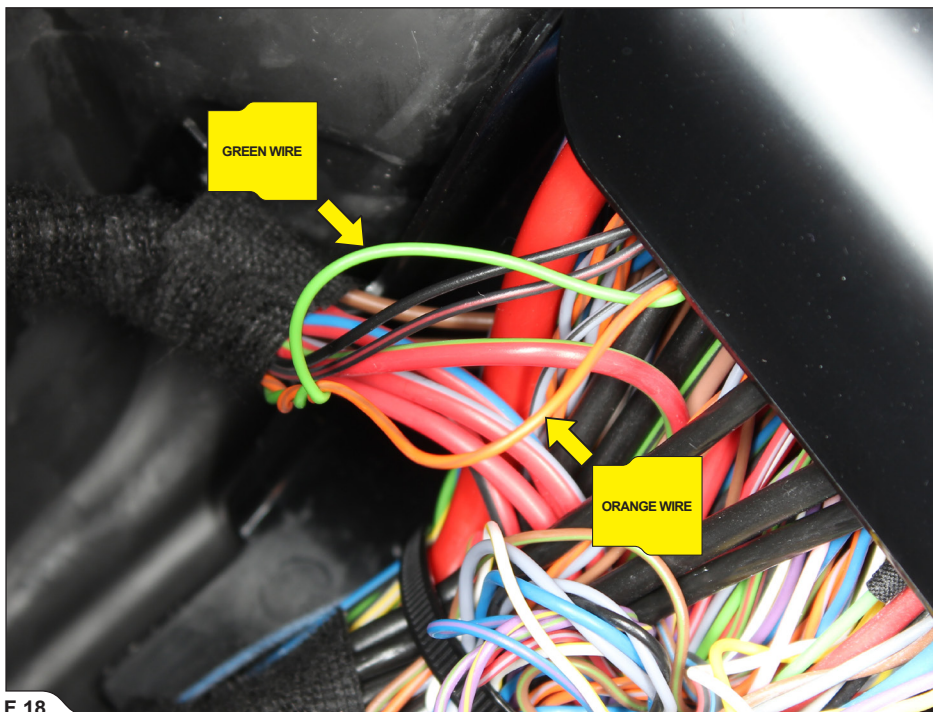

F 18

3. The Sound Kit components (F 19, 20, 21, 22, 23):

1 - Control kit

4 - T

7 - T

2

5 - T

8 - 3p to 4p adapters

3 - Power supply connectors

6 - T

9 - Connector plugs

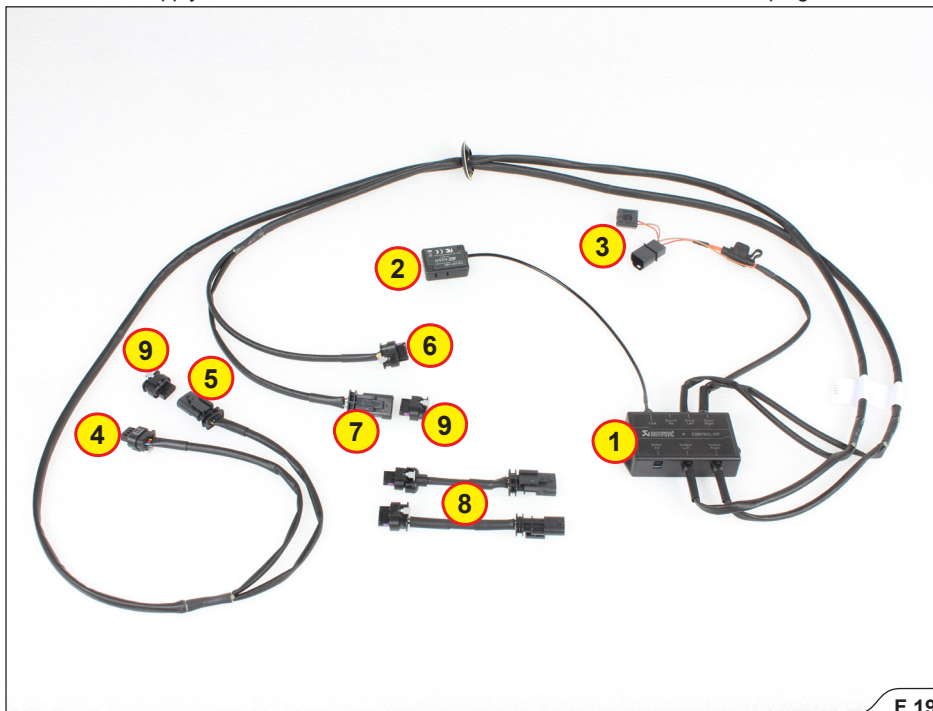

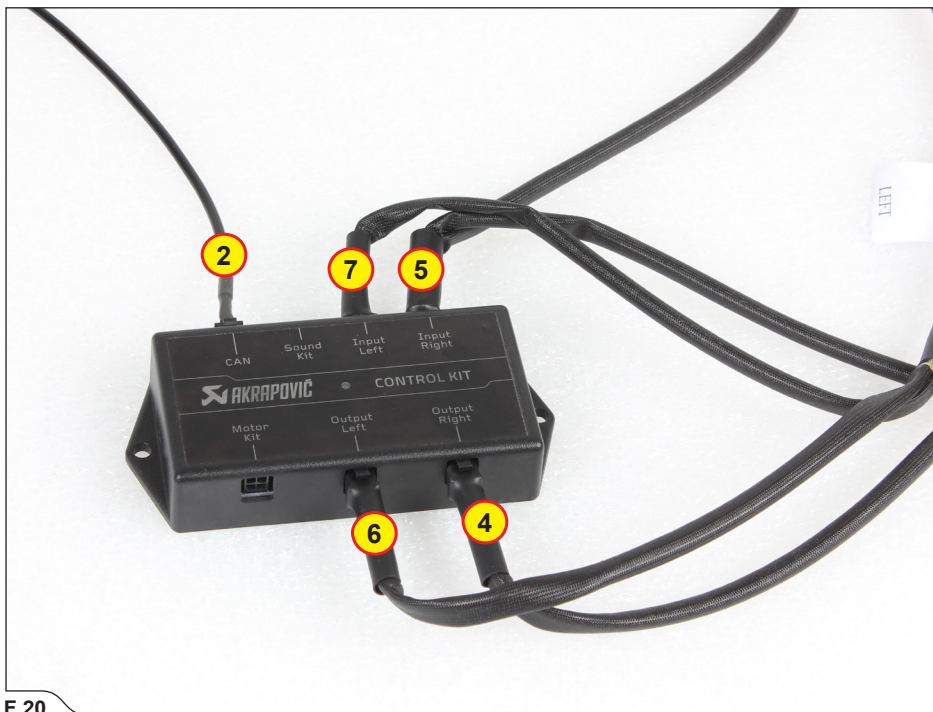

F 20

! IMPORTANT: 3pin to 4pin adapters are used for vehicles with stock 3pin connector (F 21).

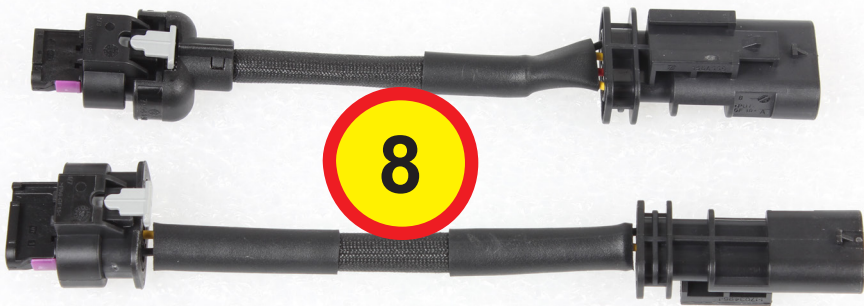

! **IMPORTANT:** connector plugs are used for vehicles WO stock exhaust flaps (F 22, 23).



F 22

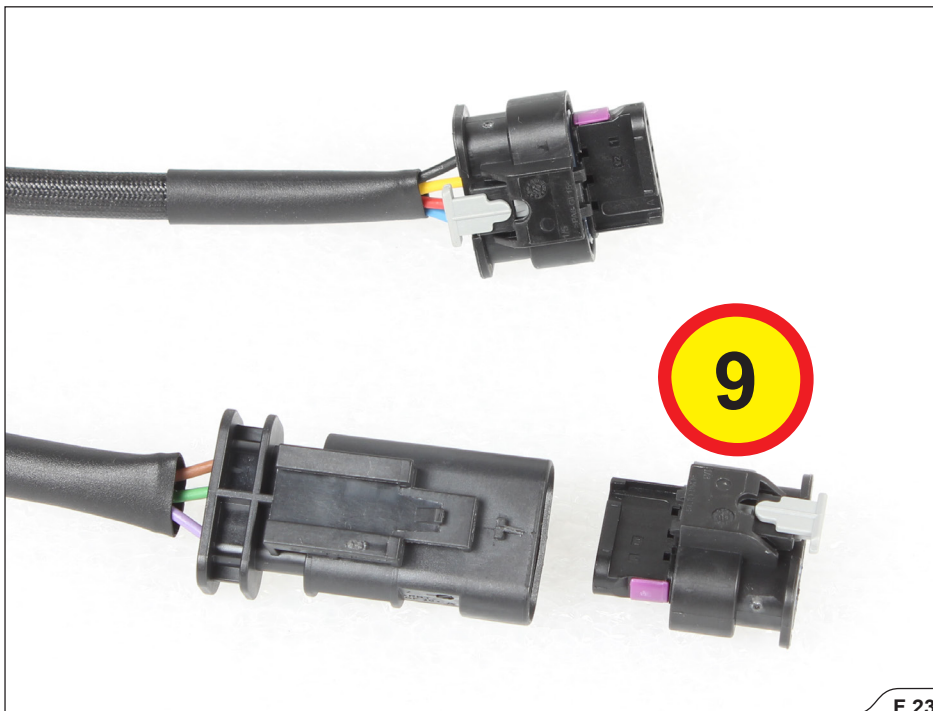

4. Carefully pull the Akrapovič exhaust wiring harness through the opening in the trunk and correctly install the rubber grommet (F 24, 25).

! **CAUTION:** make sure not to injure yourself or damage any part of the vehicle during this process!

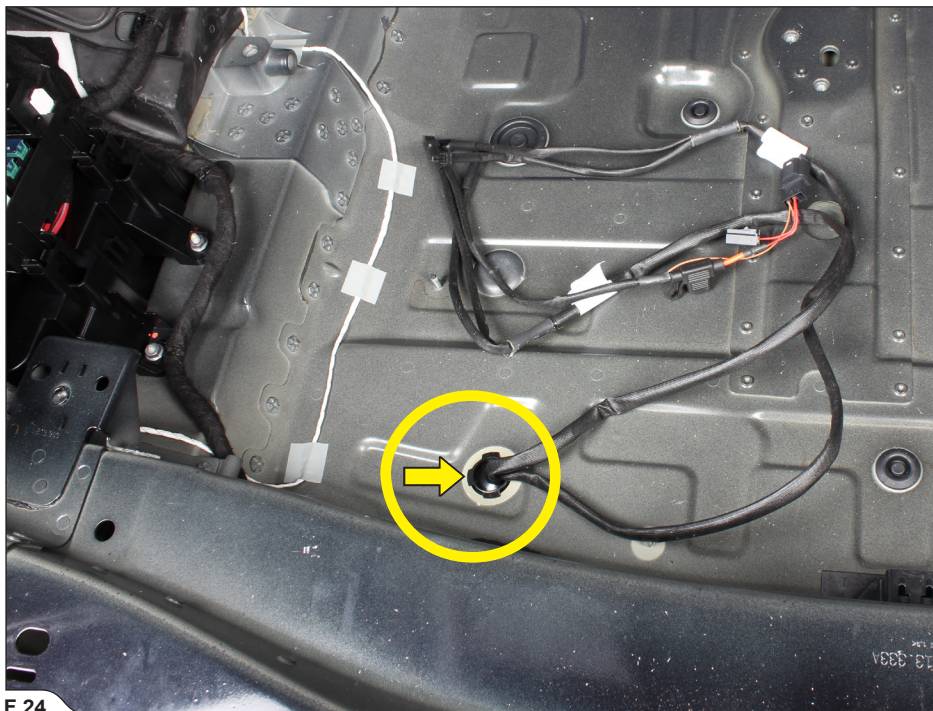

F 24

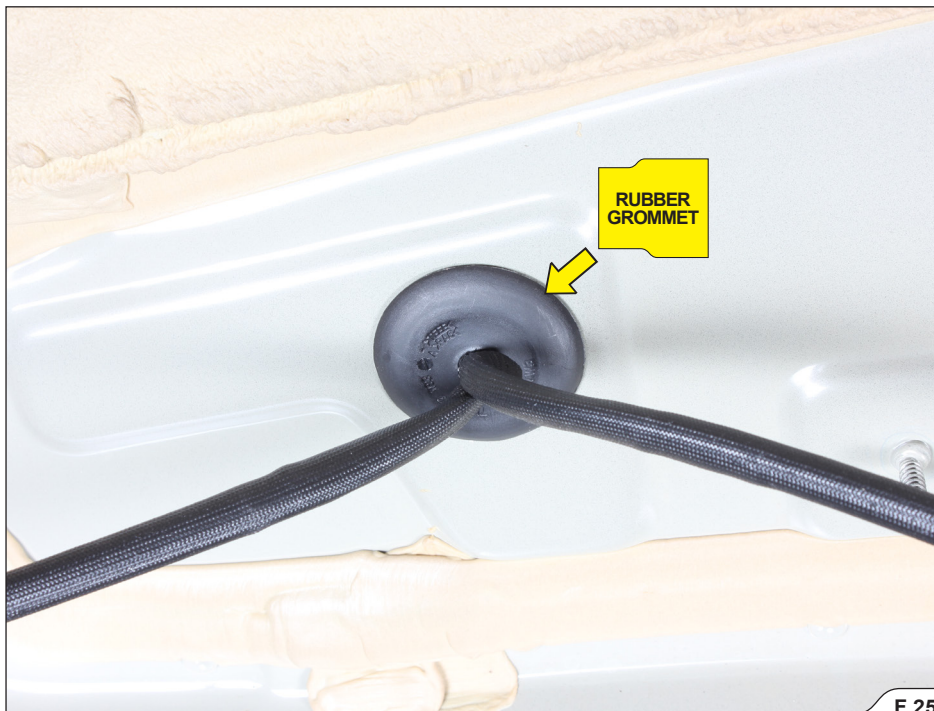

5. Lead the exhaust wiring harnesses to the left and right side of the vehicle, as shown (F 26).
! CAUTION: make sure not to injure yourself or damage any part of the vehicle during this process!

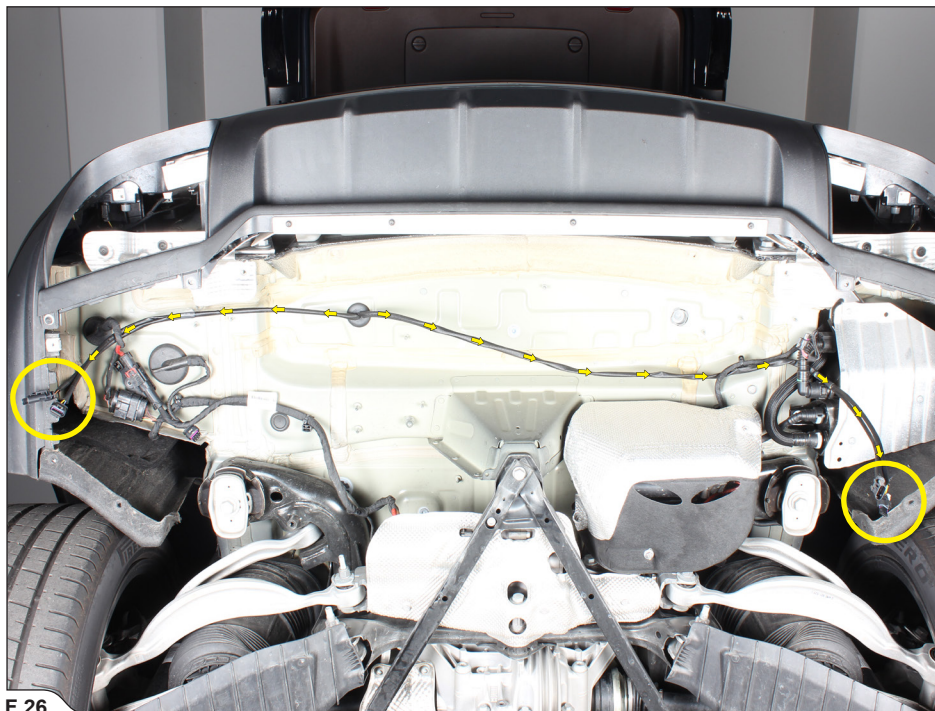

F 26

6. Reinstall the heat shield (F 27).

! **CAUTION:** make sure not to injure yourself or damage any part of the vehicle during this process!

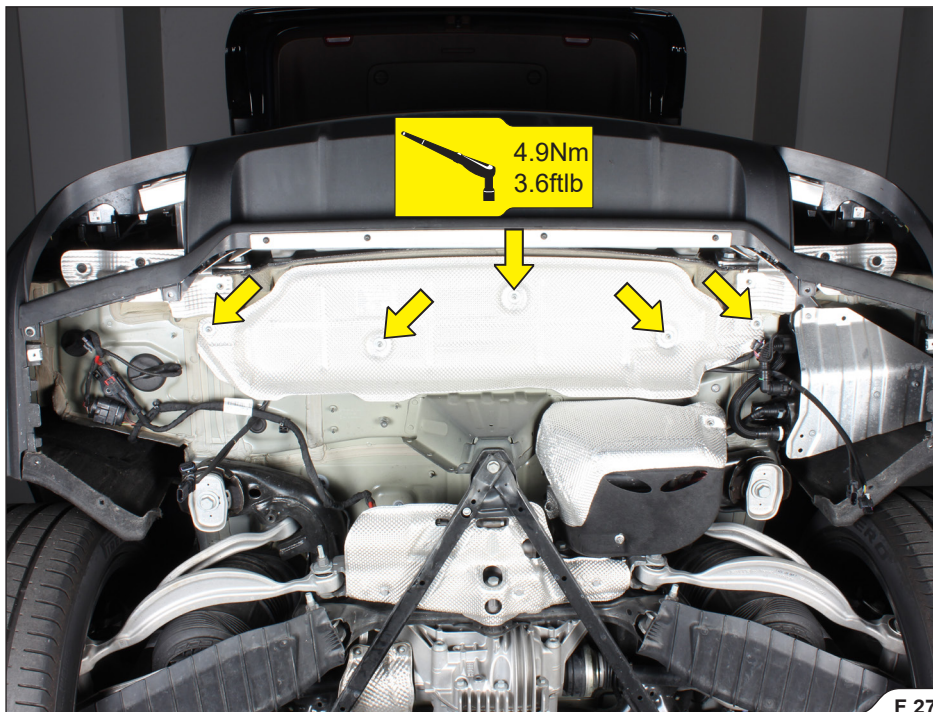

7. Install and connect the Sound kit components in the trunk, as shown; secure all wiring and components in place using tie wraps from Akrapovič installation kit (F 28, 29, 30, 31, 32).

! **IMPORTANT:** make sure to secure all Sound Kit components in such a way, that they won't touch any hot or moving parts of the vehicle!

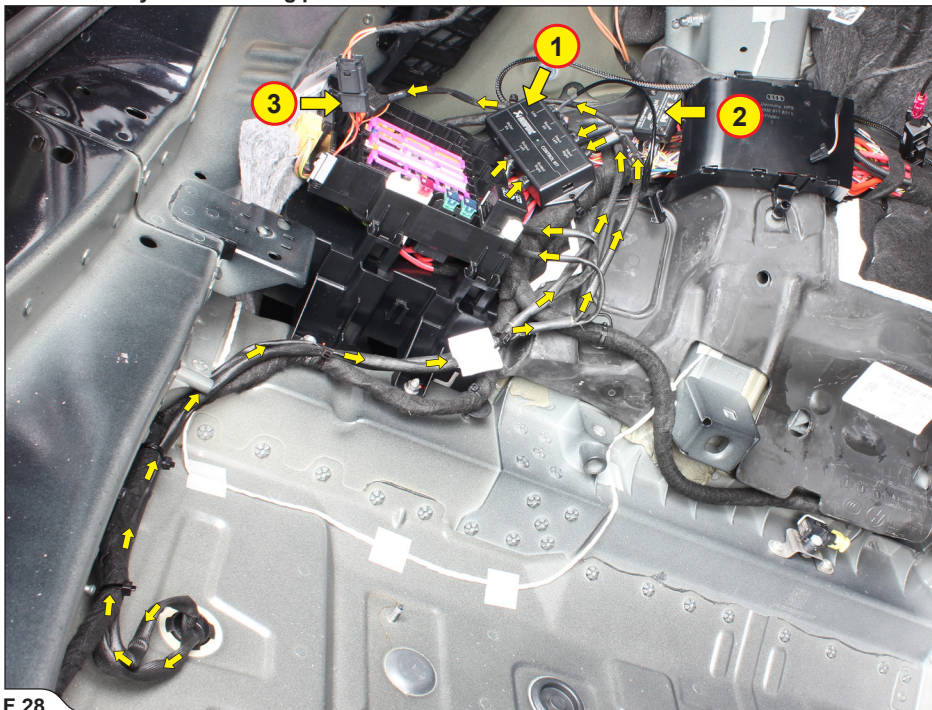

F 28

! **IMPORTANT:** connect the Sound kit's power supply connector to the vehicle's power socket connector, as shown (F 29).

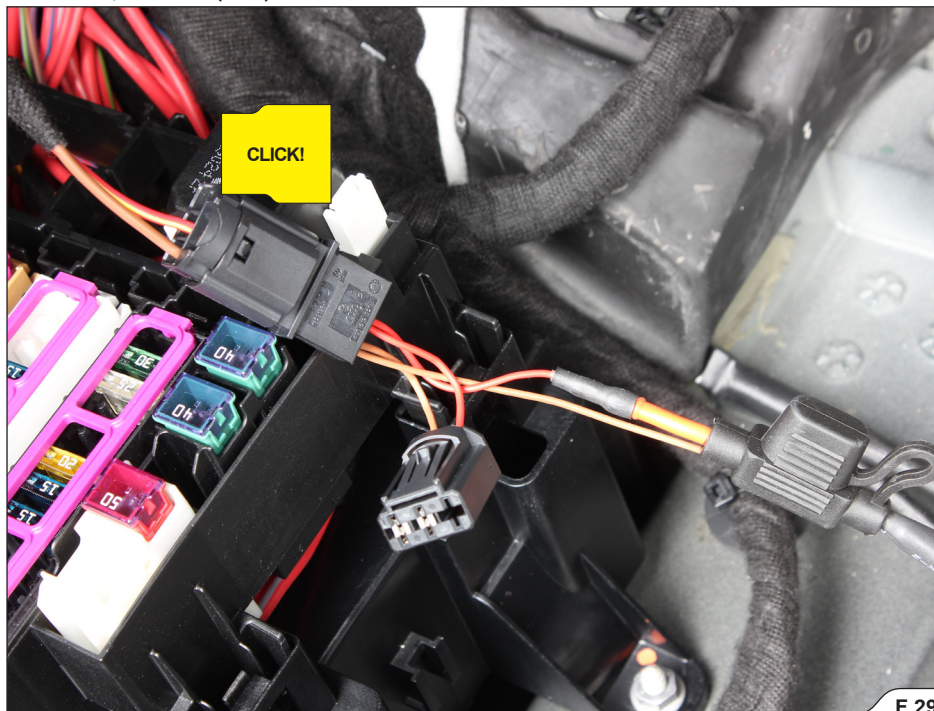

! IMPORTANT: unscrew the CAN sniffer's cover, lead the orange and green wires through the CAN sniffer's wire grooves as shown and reinstall the cover (F 30, 31).

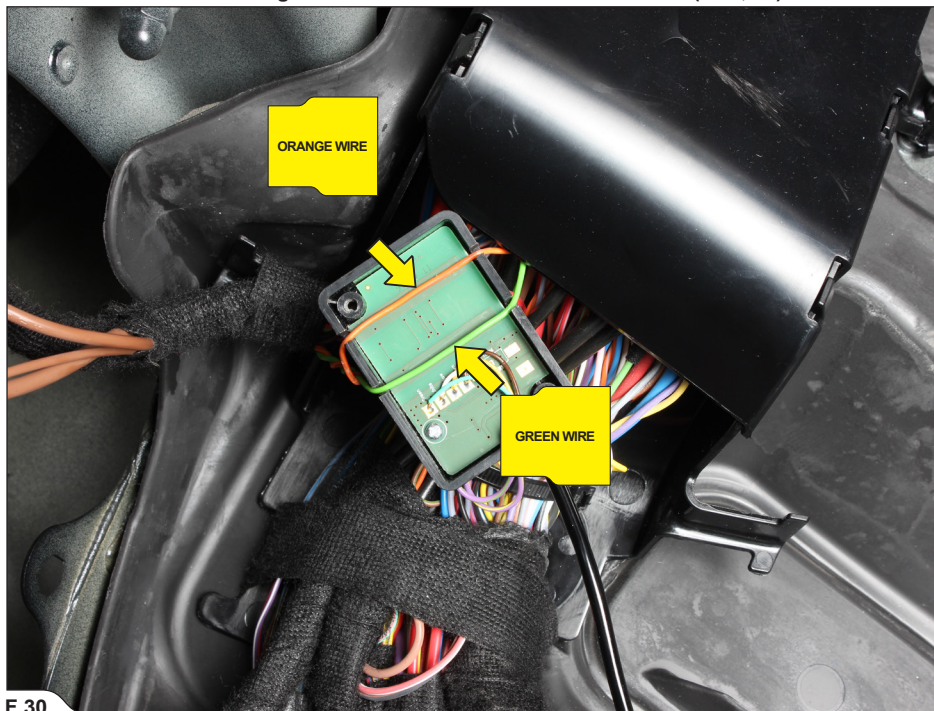

F 30

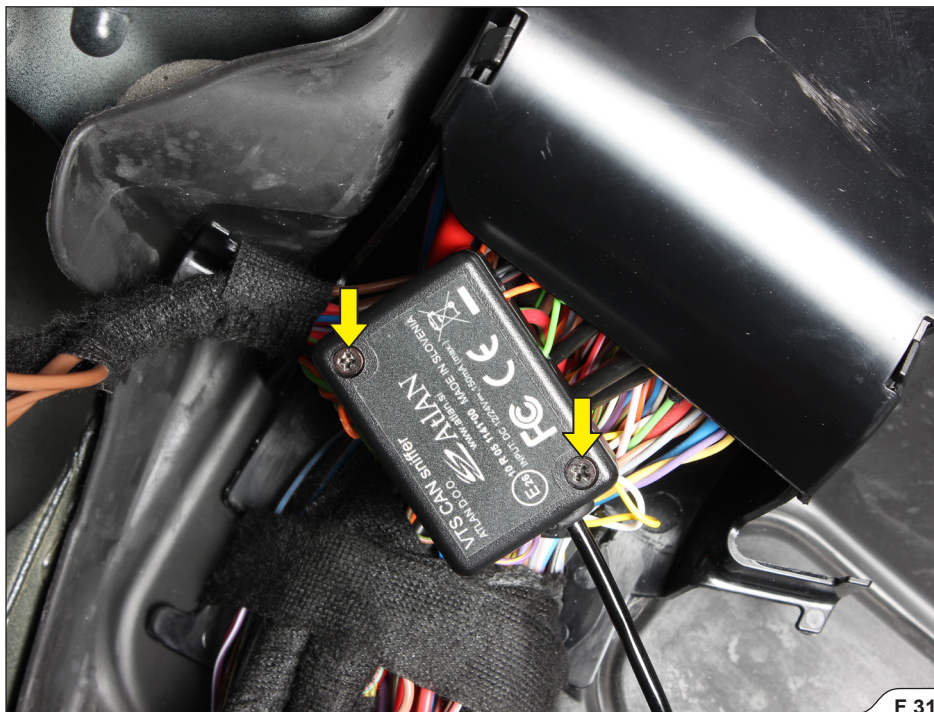

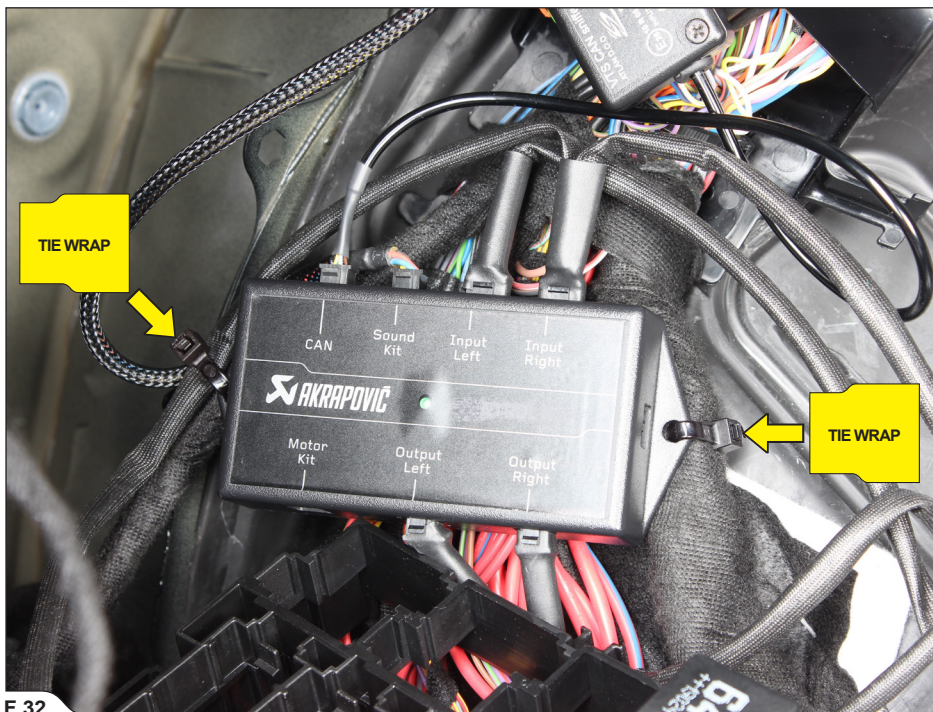

F 32

8. Mark the link pipes' outlet pipes, 42 mm (1,65 in) from the beginnings, for later adjustments, as shown (F 33).

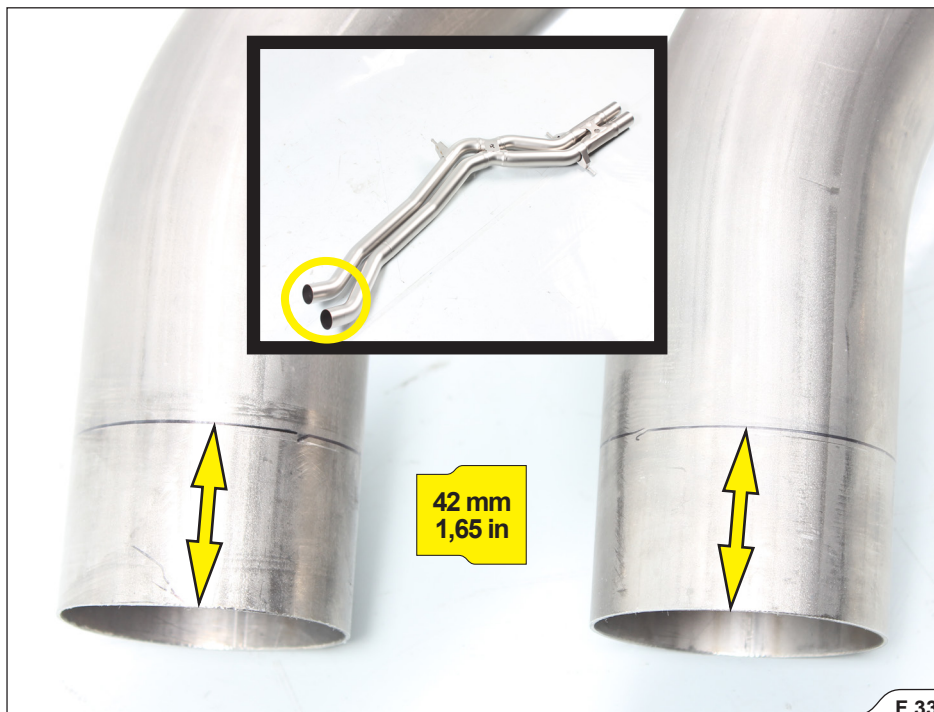

9. Assemble the _____ and link pipes (using clamps from Akrapovič installation kit), install stock rubber _____ and assemble the Akrapovič adapters with clamps onto link pipes' inlets, as shown (F 34, 35, 36, 37, 38).

INSTALLATION TIP: for easier mounting, lubricate the rubber brackets (WD40®)*.
*WD-40® is a trademark of the WD-40 Company.

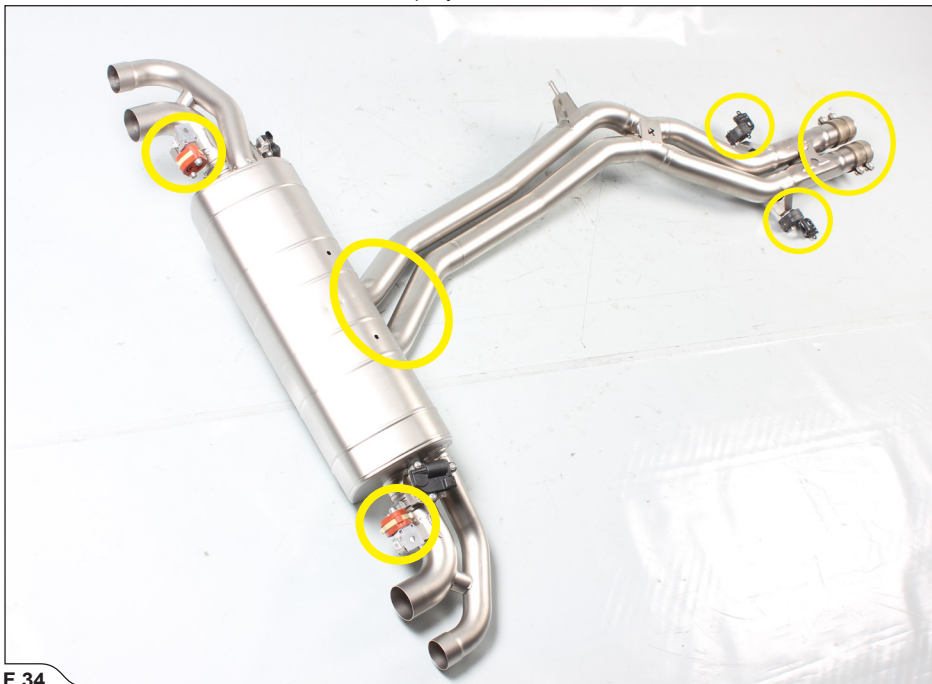

F 34

! IMPORTANT: hand tighten the clamps only (F 35)!

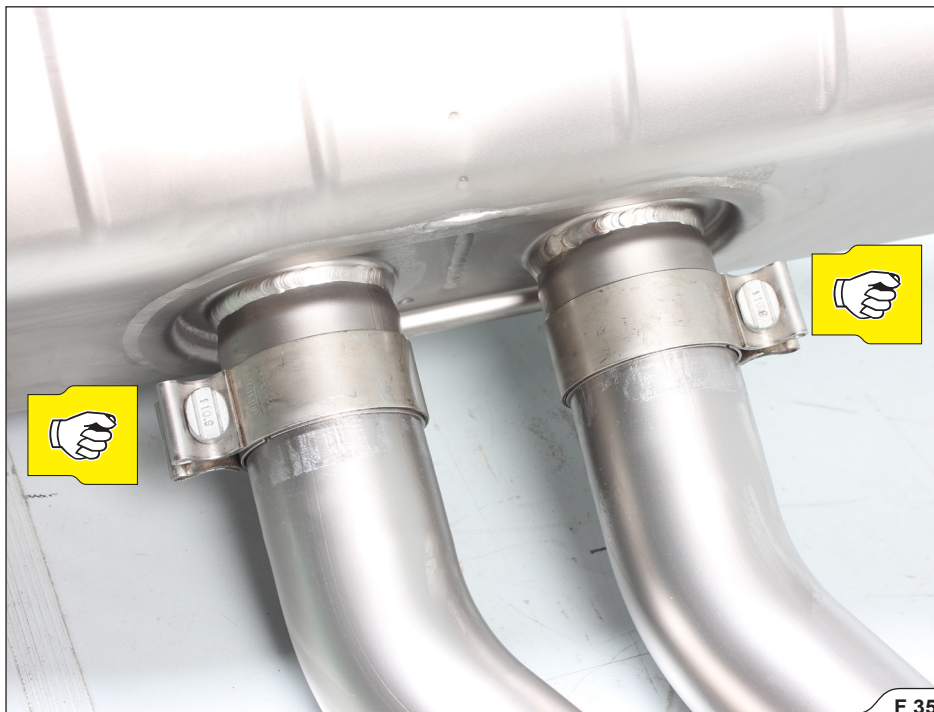

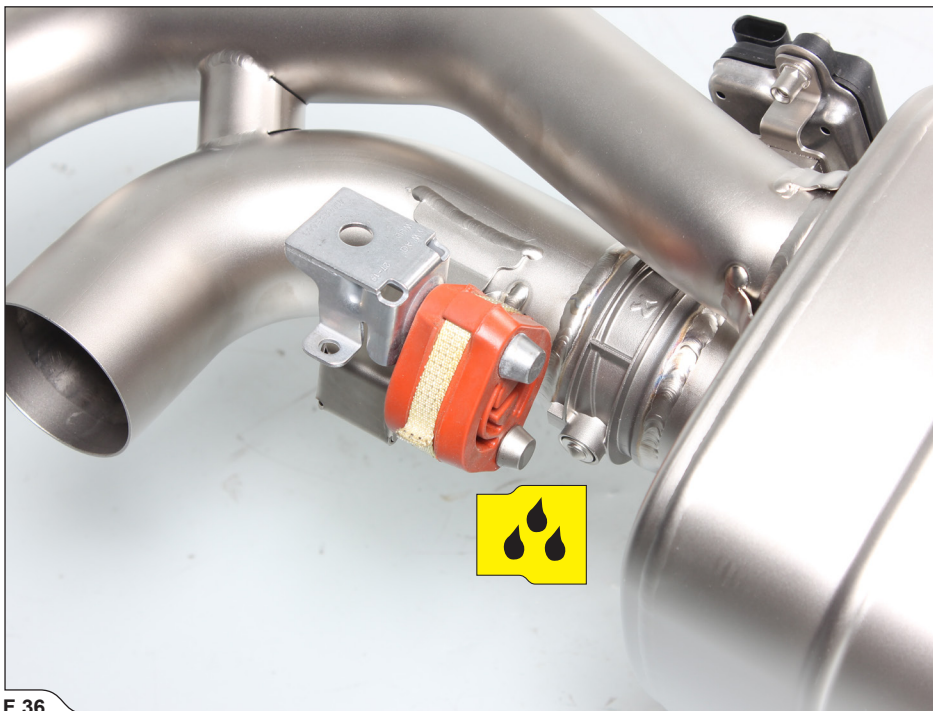

F 36

! IMPORTANT: hand tighten the clamps only (F 37)!

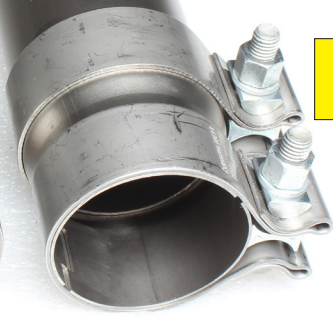

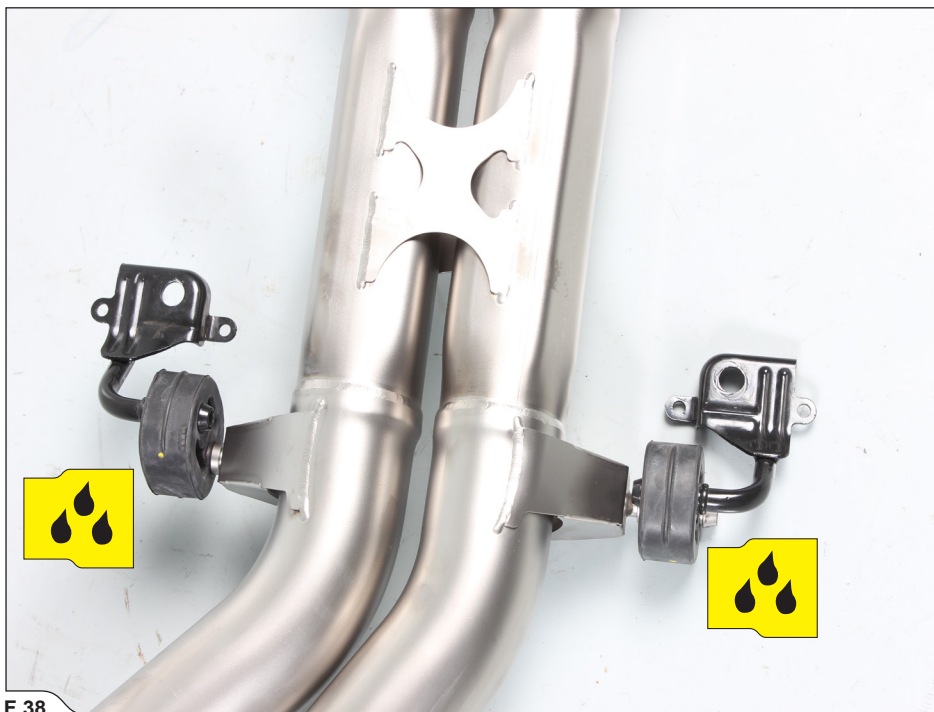

F 38

10. Carefully install the Akrapovič exhaust system onto the vehicle; tighten and attach all rubber brackets onto the chassis (F 39, 40, 41, 42).

! **CAUTION:** make sure not to injure yourself or damage the vehicle or exhaust system during this process!

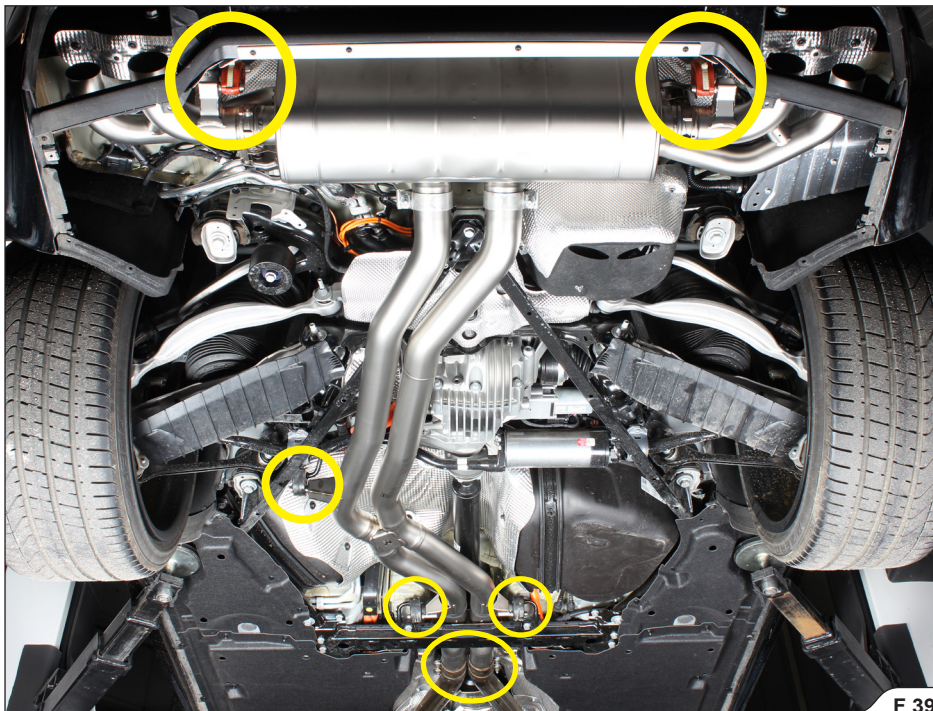

W **INSTALLATION TIP:** for easier mounting, lubricate the original rubber brackets (WD40®)*.
*WD-40® is a trademark of the WD-40 Company.

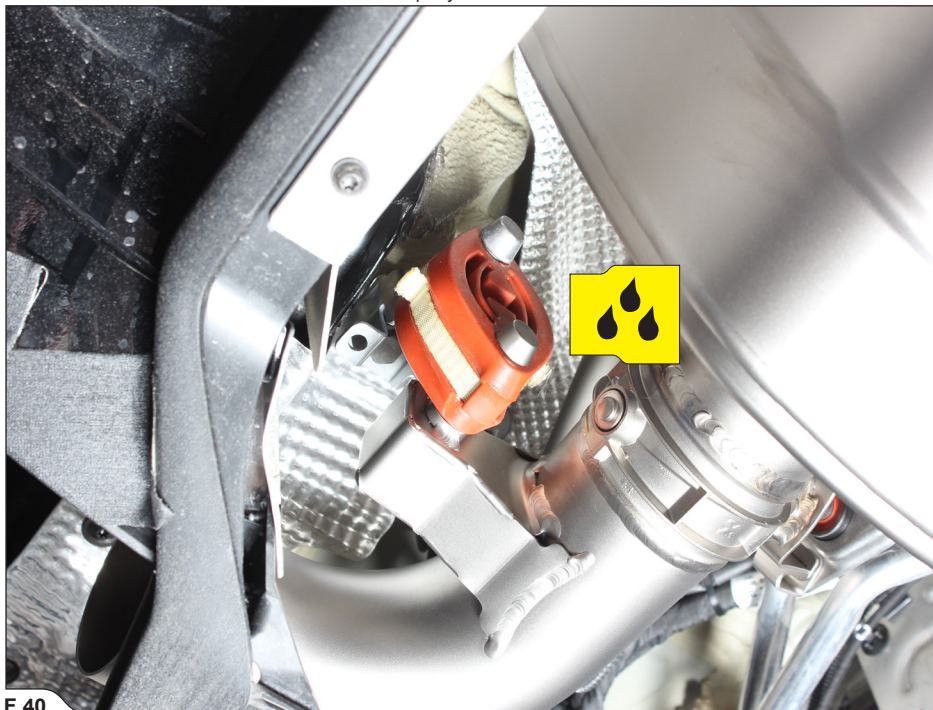

F 40

- W** **INSTALLATION TIP:** for easier mounting, lubricate the original rubber bracket (WD40®)*.
*WD-40® is a trademark of the WD-40 Company.

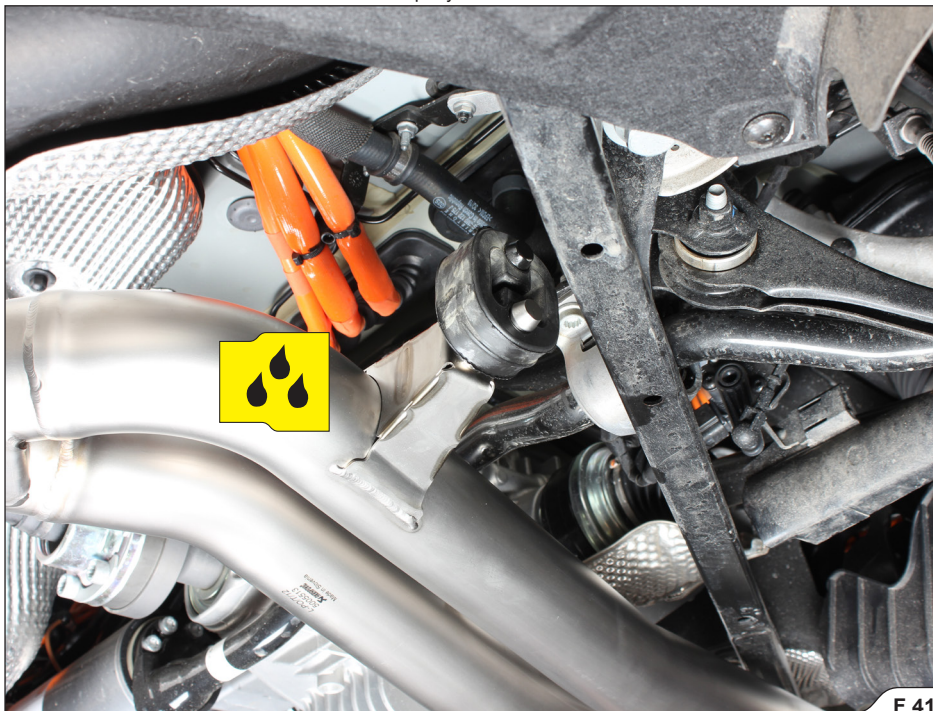

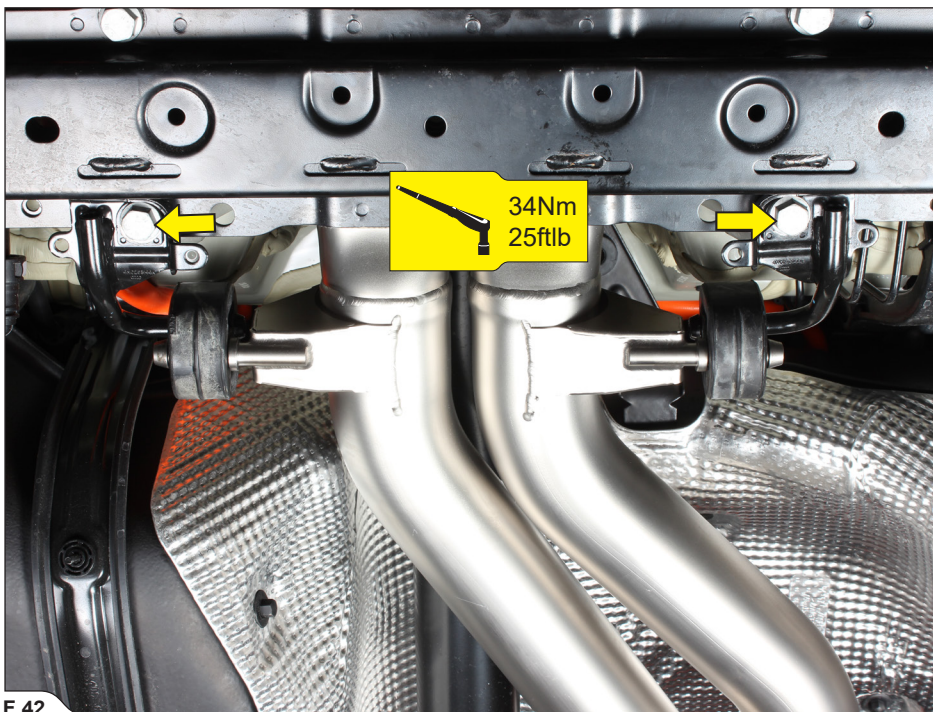

F 42

11. Push/wiggle the all the way onto the link pipes, adjust the clamps as shown and tighten the (F 43).

! CAUTION: make sure not to injure yourself or damage the vehicle or exhaust system during this process!

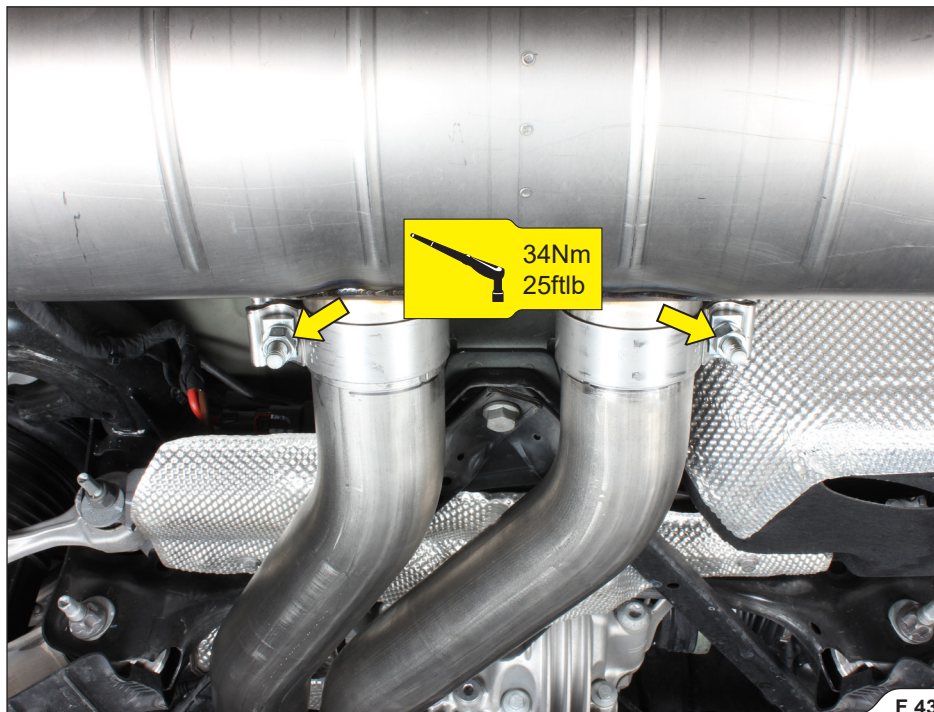

12. Align the _____ in respect to the chassis and adjust the _____ with link pipes lengthwise in such a way, that the clearance between _____ and vehicle's heat shield is minimum 12 mm (0,47 in); do not exceed the 42 mm (1,65 in) marks at the link pipes - adapter pipes connection (F 44, 45).

! CAUTION: make sure not to injure yourself or damage the vehicle or exhaust system during this process!

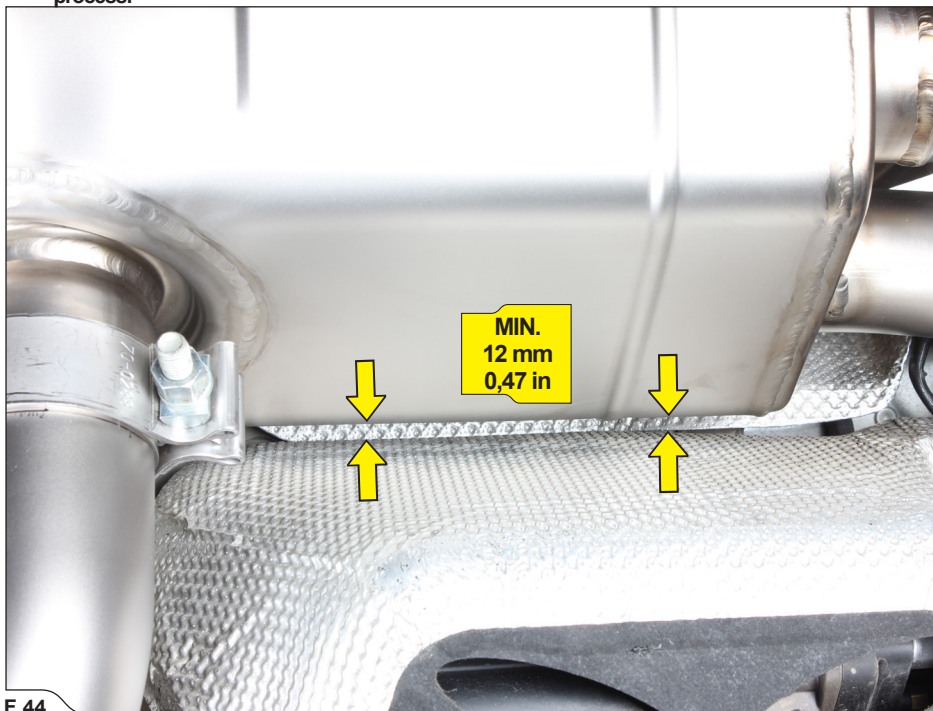

F 44

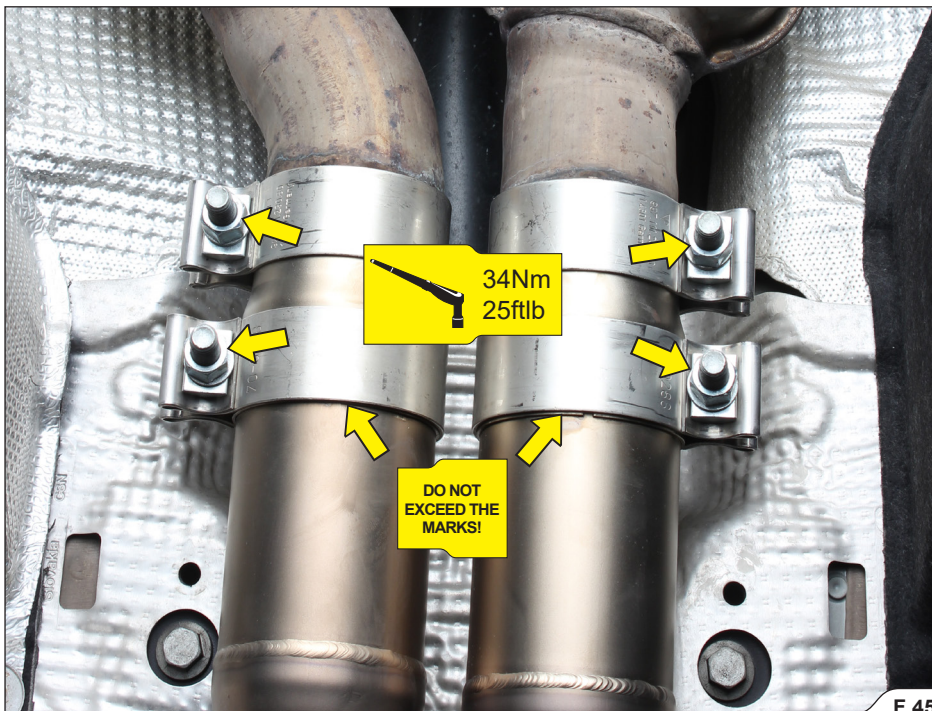

13. Install the pipe connection from Akrapovič installation kit, exactly as shown(F 46).

! **CAUTION:** make sure not to injure yourself or damage any part of the vehicle during this process!

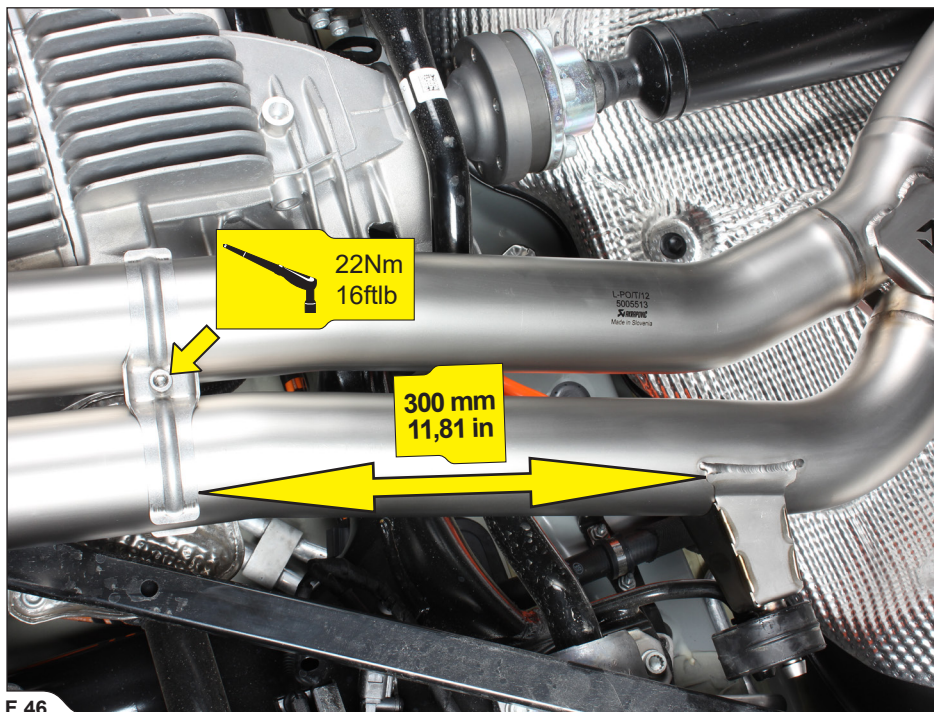

F 46

14. For vehicles WITH stock exhaust flap(s) only: connect the exhaust actuator(s), using 3pin to 4pin adapter(s) from Akrapovič installation kit; if stock connector has 4pins, no adapter(s) are necessary (F 47).

! CAUTION: make sure not to injure yourself or damage any part of the vehicle during this process!

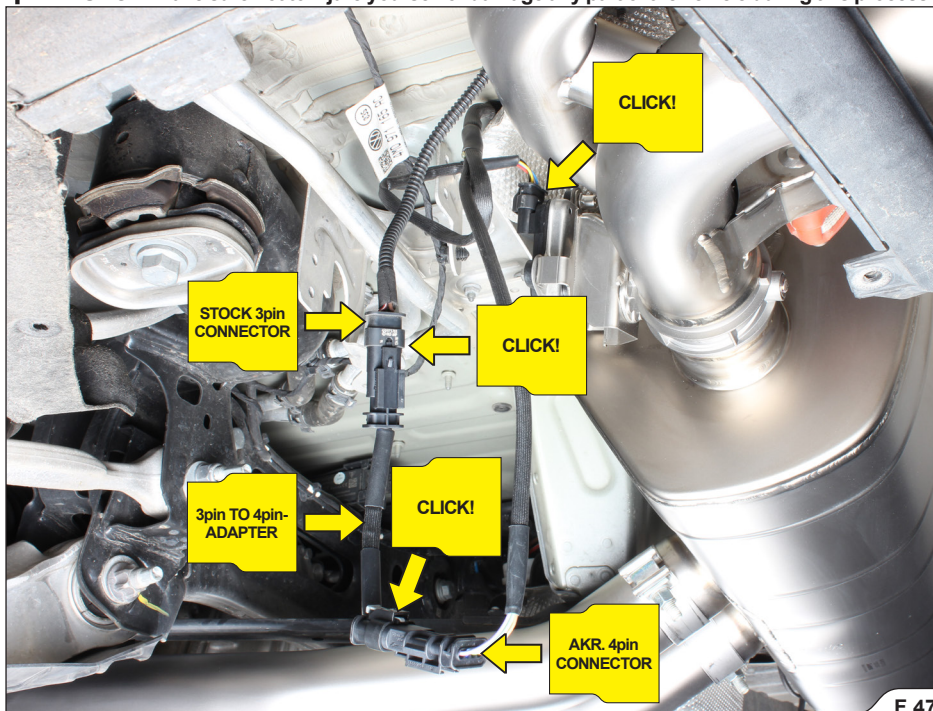

15. For vehicles **WO** stock exhaust flap(s) only: connect the exhaust actuators, and plug the free connectors, using plugs from Akrapovič installation kit (F 48).

! **CAUTION:** make sure not to injure yourself or damage any part of the vehicle during this process!

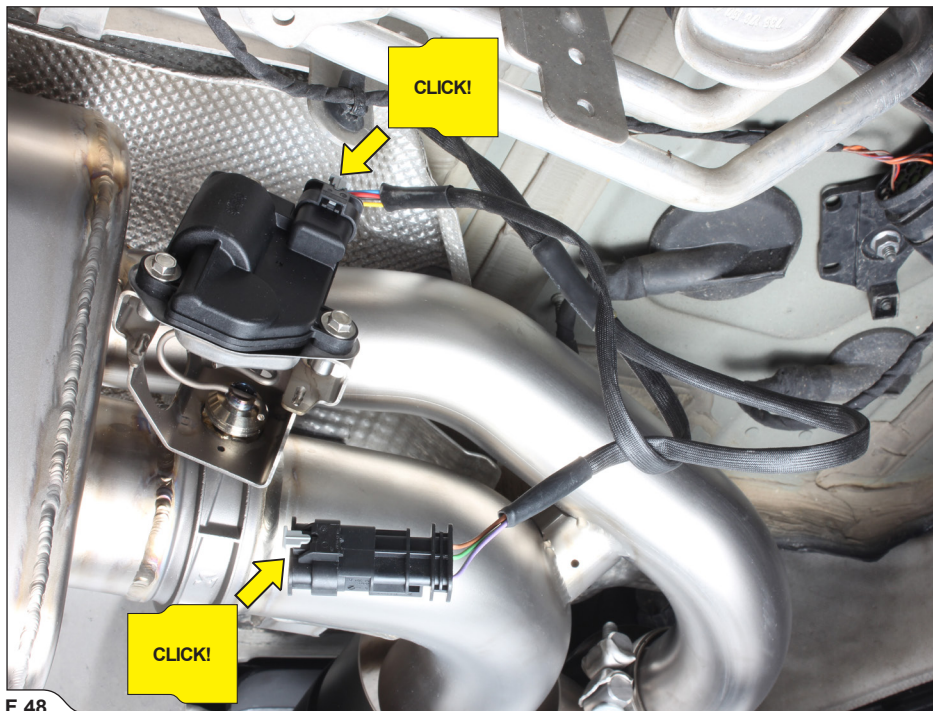

F 48

16. Secure the wiring and connectors, as shown, using tie wraps from Akrapovič installation kit (F 49, 50).

! **IMPORTANT:** make sure to secure the wiring harness in such a way, that it won't touch any hot or moving parts of the vehicle!

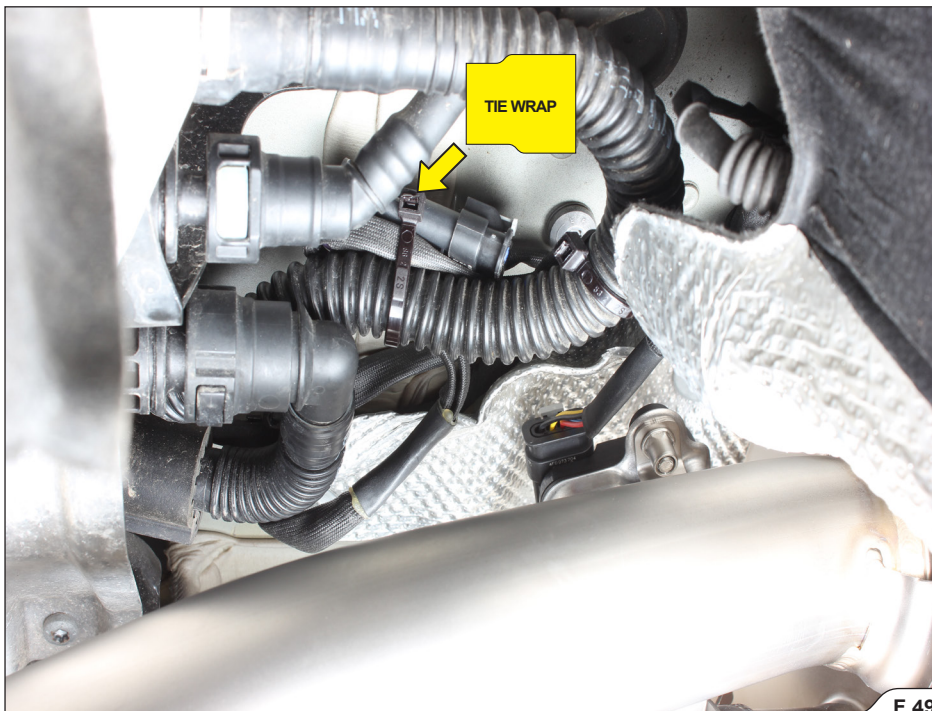

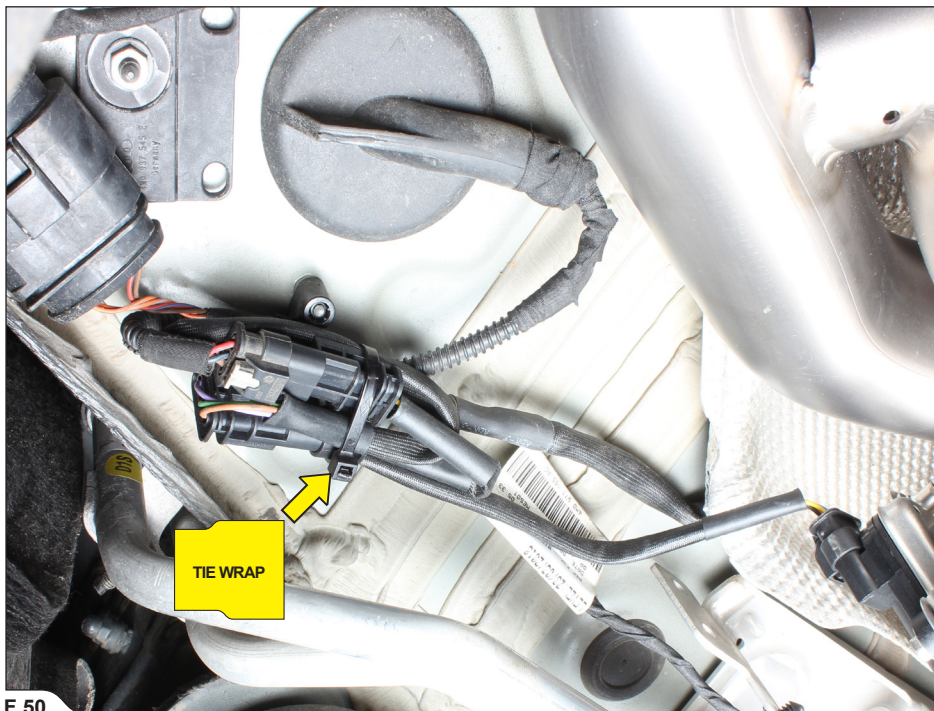

F 50

17.

(F 51, 52, 53).

! **IMPORTANT:** make sure, not to damage tail pipes, bumper or any part of the vehicle during this process!



F 51



F 52



18. Rotate and center the tail pipes in respect to rear bumper and according to your personal preference (F 54, 55, 56).

! IMPORTANT: the minimum clearance between tail pipes and stock heat shield at any point is 8 mm (0,32 in)!





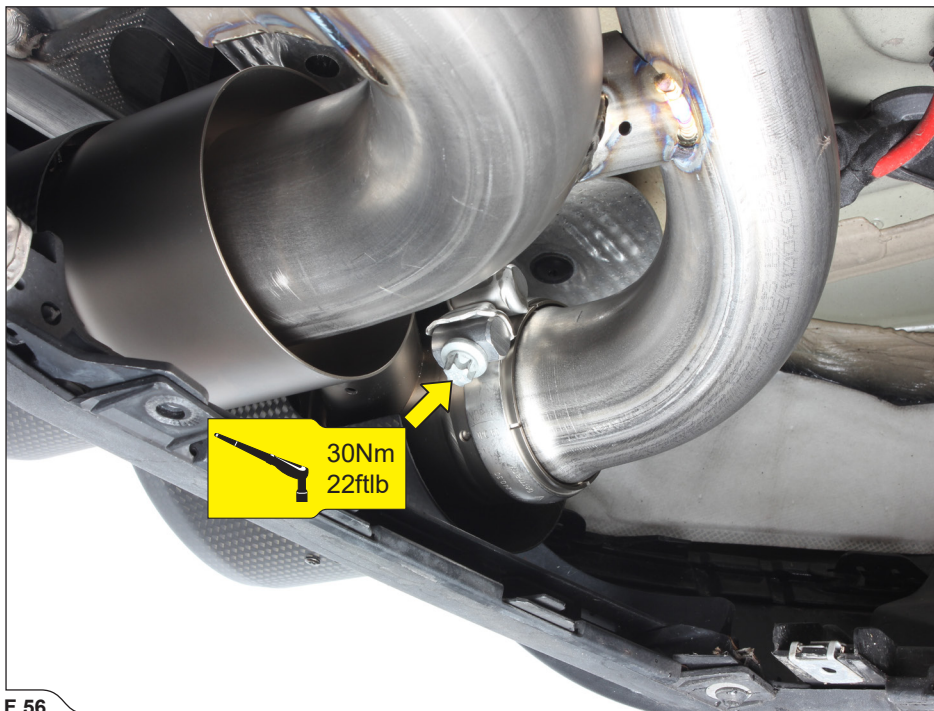

F 56

FINAL INSTALLATION:

- ! **IMPORTANT:** reinstall the dismantled or partially removed stock parts (wheel arches, bumper etc.); check vehicle manufacturer manual for tightening torques.
- ! **IMPORTANT:** make sure all the nuts and bolts are sufficiently tightened. In case the exhaust system touches the cowl or other parts, repeat the adjustment of the exhaust system or contact your authorized dealer.
- ! **IMPORTANT:** clean all exhaust components before the first start of the engine or the stains will burn onto the surfaces!

MAINTENANCE OF THE AKRAPOVIČ EXHAUST SYSTEM:

1. Clean the titanium exhaust components with a multi-purpose spray lubricant (WD-40[®] or equivalent)*, carbon exhaust components with soft and dry cloth and stainless steel components with soft cloth sprayed with contact cleaner, then wipe with soft and dry cloth. A change in the color of the exhaust system is normal due to high temperatures.
- 2.

*WD-40[®] is a trademark of the WD-40 Company.



INSTALLATION TIP: IT IS NORMAL FOR WHITE SMOKE TO COME OUT OF THE MUFFLER AT FIRST OPERATION.

- ! **CAUTION: DO NOT STAND BEHIND THE MUFFLER AT ANY TIME.**
- ! **CAUTION: DO NOT USE AUTOMOTIVE WHEEL CLEANERS OR ANY CLEANING PRODUCTS WHICH CONTAIN ACIDIC ADDITIVES TO CLEAN THE AKRAPOVIČ EXHAUST SYSTEMS.**

WARNING: THE EXHAUST SYSTEM CAN BE EXTREMELY HOT. ALLOW THE EXHAUST AND ENGINE TO COOL DOWN BEFORE BEGINNING INSTALLATION OR ANY OTHER WORK ON THE EXHAUST SYSTEM. THIS MANUAL IS SPECIFIC TO THE PORSCHE CAYENNE S TYPE 536. THERE MAY BE SOME DIFFERENCES IN INSTALLATION PROCEDURES FOR OTHER MODELS.

TROUBLESHOOTING:

Problem	Possible cause	Solution
pipe clamp connections	loosened clamp	
	connection is not completely joined	tap the connection into place and tighten the
Valves are not moving	No supply	Check green LED on the Control Kit. If the LED is off: <ul style="list-style-type: none">• Check electrical connection and connectors• Check fuse for exhaust valves (in the trunk, right)
	Error detected	Check green LED on the Control Kit. If the LED blinks one time per period: <ul style="list-style-type: none">• Check Left input harness and connectors. If the LED blinks two times per period: <ul style="list-style-type: none">• Check Right Input harness and connectors. If the LED blinks three times per period: <ul style="list-style-type: none">• Check Left Output harness and connectors. If the LED blinks four times per period: <ul style="list-style-type: none">• Check Right Output harness and connectors. If the LED is continuously blinking: <ul style="list-style-type: none">• installed.• connector Period lasts approximately one second.