



Installation instructions

Akrapovič Exhaust System:

Evolution Line

for the

Alfa Romeo Giulia Quadrifoglio (type 952)

SAFETY AND COMPLIANCE WARNING, PLEASE READ CAREFULLY

BEFORE REMOVING THE STOCK EXHAUST SYSTEM AND BEGINNING THE INSTALLATION OF YOUR NEW AKRAPOVIČ EXHAUST, PLEASE MAKE SURE THAT ALL ITEMS LISTED BELOW ARE VERIFIED:

- This manual is specific to the car indicated on the cover page, for which it is designed. Installation procedures vary depending on the type of car. Please verify that the Akrapovič **exhaust system and this installation manual correspond to the type of your car.**
- The exhaust system can get extremely hot during and after it is used. Make sure not to touch the exhaust system until it is completely cool. **Allow the exhaust and engine to cool down before beginning installation.**
- Make sure the car is **securely positioned to prevent** damage to yourself and other, or the car.
- Make sure that you have **all the parts necessary for the installation** of your new Akrapovič exhaust system. If any of the parts is missing, please do not proceed with uninstalling your stock exhaust system/installing the Akrapovič exhaust system and contact the retailer where you purchased the Akrapovič exhaust system.
- Every exhaust system muffler has its unique serial number, which identifies the authenticity of the product. You can find the serial number on the muffler's sleeve. Please refer to the **picture 1** below. Please verify that your exhaust system is an original Akrapovič product. If you have any doubts, please contact the reseller where you purchased the exhaust system or Akrapovič partners. This manual, any certificates and Akrapovič warranty apply to original products only.

GENERAL NOTE

Photographs and other illustrations in this manual are symbolic and are intended to help represent individual steps for proper installation and use, as well as for a general overview. The actual component parts of the Akrapovič exhaust system may not entirely correspond to the photographs and other illustrations.

Picture 1 - Serial Number Position

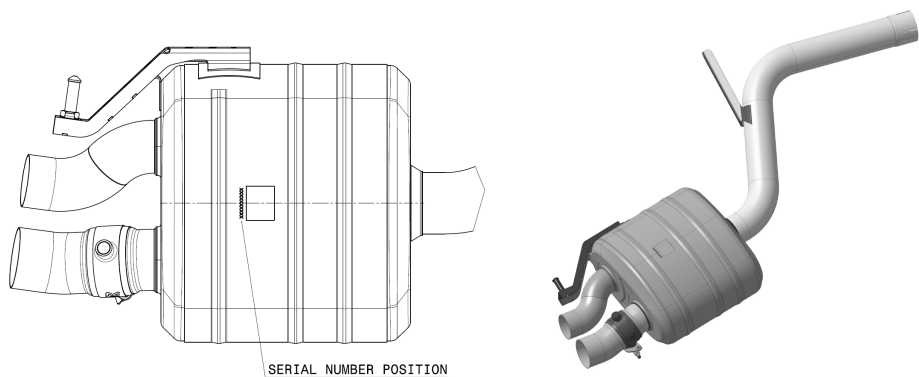

NOISE AND EMISSION WARNINGS

General warning

Because of the world-wide distribution of Akrapovič d.d. products, neither Akrapovič d.d. nor any of its subsidiaries make any representation that the exhaust system complies with the air and/or noise emissions laws, or labeling laws, of any jurisdiction. The purchasers are entirely responsible for informing themselves of the applicable laws where the products are to be used and to comply with those law.

USA WARNING

Various U.S. states and the U.S. federal government have individual laws regulating the use of aftermarket exhaust parts and systems, especially as those parts and systems modify, remove, or replace original equipment catalysts. Please consult the appropriate laws in your area before installing any aftermarket part or system on your vehicle to ensure compliance with all applicable laws. Neither Akrapovic d.d. nor any of their subsidiaries or the sellers of the parts or systems make any representation that any of their parts or systems comply with any such laws.

CALIFORNIA WARNING

California laws prohibit the use of any aftermarket exhaust part or system that modifies, removes or replaces original equipment catalysts unless the California Air Resources Board has issued an Executive Order regarding such part or system or unless the part or system is exempted by being used only on racing vehicles on closed courses. Neither Akrapovic d.d. nor any of their subsidiaries make any representation that any of their parts or systems has received such an Executive Order or that any of their parts or systems conform with the racing vehicles exemption. The purchasers are entirely responsible for informing themselves of applicable California laws and to comply with those laws.

SYMBOLS

The following symbols are used throughout these installation instructions:



**TOOLS AND PROTECTIVE
EQUIPMENT REQUIRED**



TIGHTENING TORQUE



LUBRICATION



HAND TIGHTEN



INSTALLATION TIP



CAUTION OR IMPORTANT

USE BOLT SEALANT

Apply 3 to 4 small drops of bolt sealant onto the cleaned and degreased threads before tightening the bolts.

WARNING! Avoid contact with skin, eyes and mucous membranes. Do not inhale fumes. Keep out of reach of children.



USE ANTI-SEIZE LEAD-FREE COPPER PASTE (black tube)

Provides trouble-free and long-lasting protection against seizing, corrosion and rusting of bolts, threaded ends, nuts, joints, etc. Also protects against vibration, wear and impact. **WARNING! Avoid eye contact. Keep out of reach of children.**



USE ANTI-SEIZING GREASE (white tube)

Prevents seizing, corrosion and excessive wear between the titanium components of your exhaust system. **WARNING! Avoid eye contact. Keep out of reach of children.**



Tools & equipment

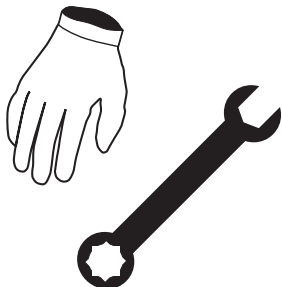

- mechanic gloves
- eye protection
- Torx 25
- Torx 30
- Socket 15 mm
- Socket 16 mm
- T-handle swivelling 13 mm wrench
- T-handle 10 mm wrench
- Rubber bracket unhooking tool
- Pry bar
- Cross head screwdriver
- Cutting nippers

PARTS LIST

The following parts should be found in the box:

- Installation Manual
- Homologation certificate/ compliance documents if applicable
- Warranty
- Fitting material
- Muffler and pipes

IMPORTANT: The car should be in the off position throughout the dismantling and installation process, as well as any other work done on the exhaust system!

REMOVAL OF STOCK EXHAUST SYSTEM:

The process of uninstalling the original exhaust system may vary depending on the existing exhaust system. Please follow the original exhaust system manufacturer's instructions for uninstalling the original exhaust system.

If you for any reason decide otherwise, please note that any information provided in this respect herein should be considered as general information provided for your convenience only. Akrapovič shall not assume any liability or responsibility with regard to uninstalling your existing exhaust system, warranty coverage of such exhaust system or vehicle or their further fitness for use.

In case your Akrapovič exhaust system may not be used on certain roads or under certain conditions, please keep the stock or other exhaust system that you can use in such circumstances legally.

REMOVAL OF STOCK EXHAUST SYSTEM:

Put the vehicle onto a car lift.

! **CAUTION:** ensure that the car is lifted safely and properly in order to avoid the risk of vehicle damage, injury, or even death!

1. Carefully remove the rear and middle under-floor panels; check the vehicle manufacturer workshop manual for correct procedures (F 01, 02).

! **CAUTION:** make sure not to injure yourself or damage any part of the vehicle during this process!

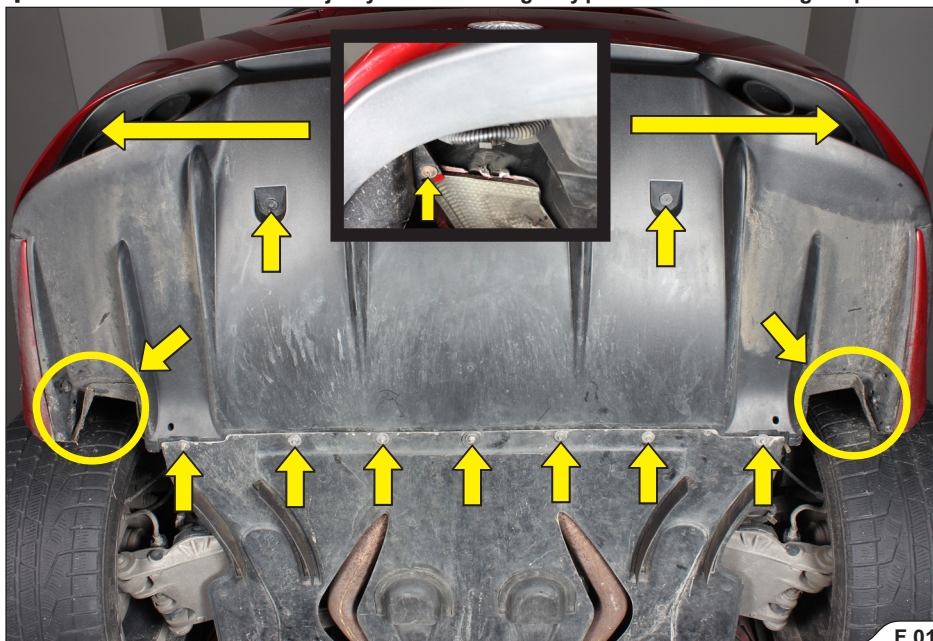

F 01

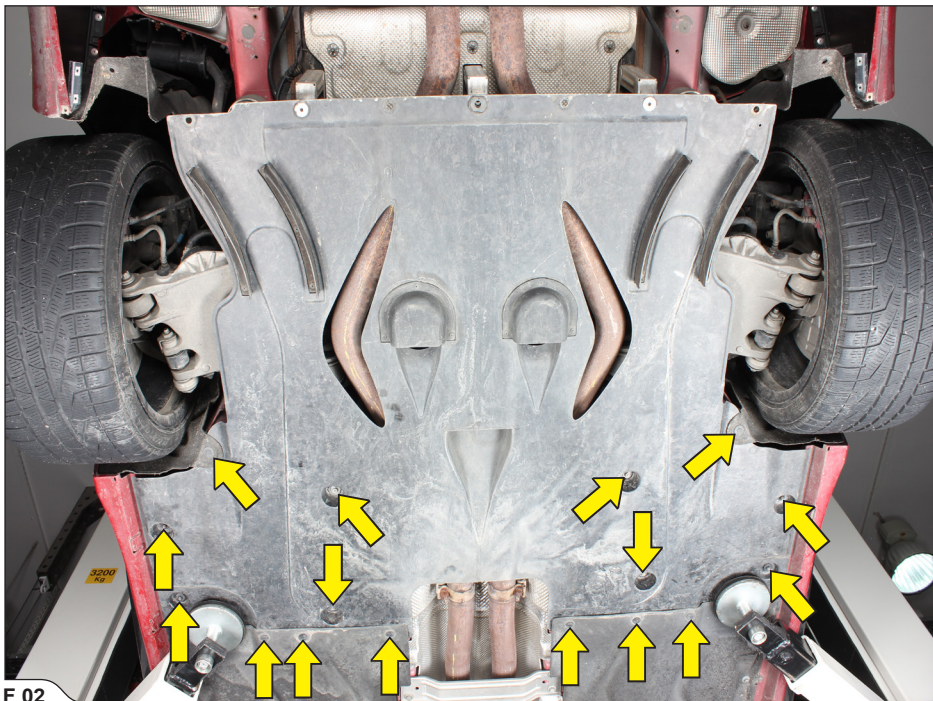

F 02

2. Unscrew the marked bolts and remove chassis reinforcement off the vehicle (F 03).

! **CAUTION:** make sure not to injure yourself or damage any part of the vehicle during this process!

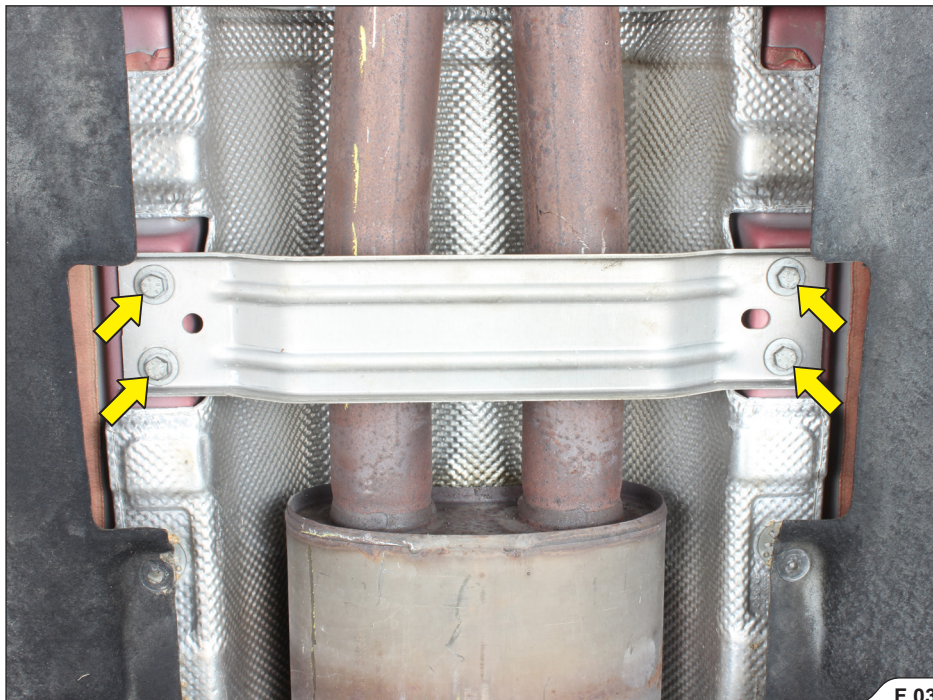

F 03

3. Loosen the marked clamps and unscrew the marked rubber brackets' bolts (F 04).

! **CAUTION:** make sure not to injure yourself or damage any part of the vehicle during this process!

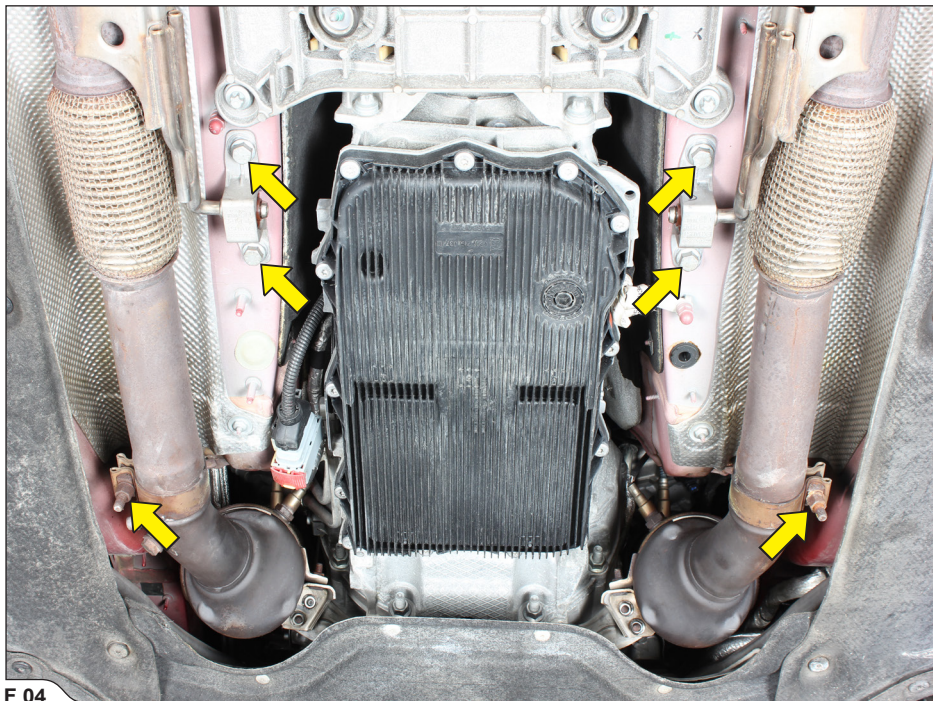

F 04

4. Support the exhaust system, undo the middle rubber brackets off the pins and carefully pull the vacuum tubes off both valve actuators (F 05, 06, 07).

! CAUTION: make sure not to injure yourself or damage any part of the vehicle during this process!

✂ INSTALLATION TIP: for easier dismantling, lubricate the original rubber brackets (WD40®)*.

*WD-40® is a trademark of the WD-40 Company.

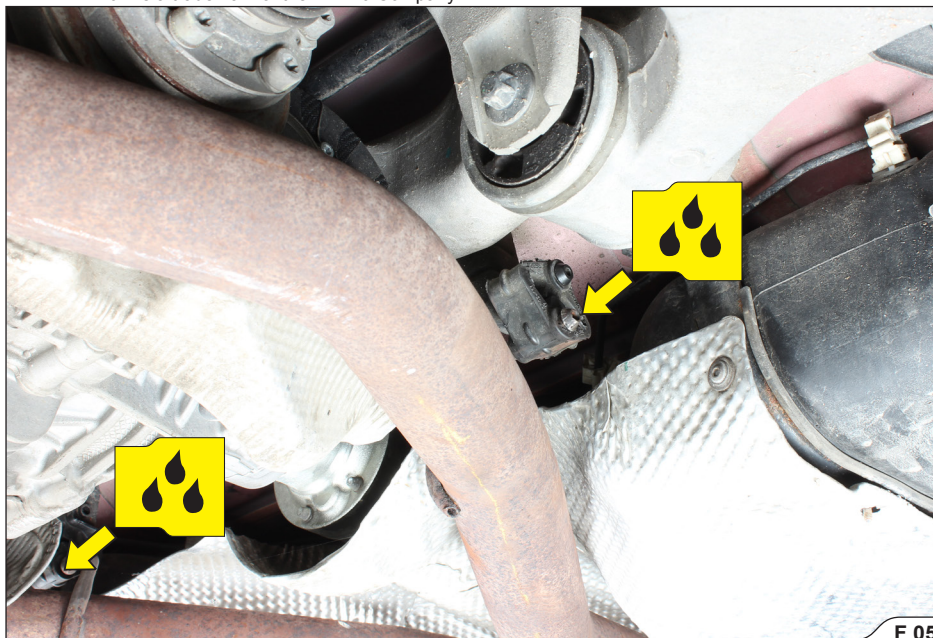



F 06

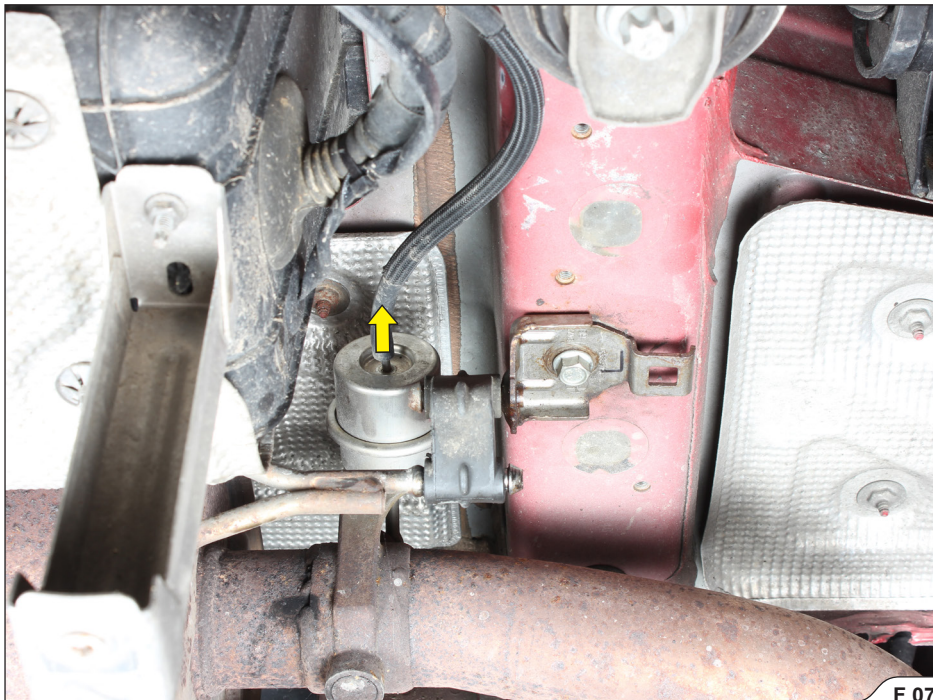

- Support the exhaust system, unscrew the marked bolts and nuts and carefully remove the exhaust system off the vehicle (F 08).

! **CAUTION:** make sure not to injure yourself or damage any part of the vehicle during this process!

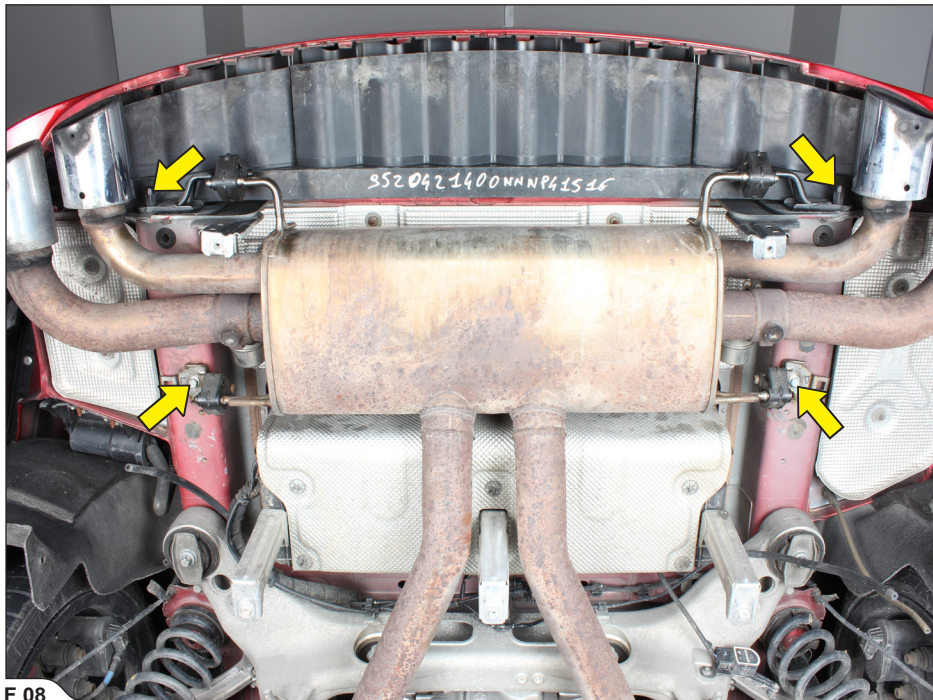

F 08

6. Carefully remove the marked rubber brackets off the exhaust system (F 09).

W **INSTALLATION TIP:** for easier dismounting, lubricate the original rubber brackets (WD40®)*.

*WD-40® is a trademark of the WD-40 Company.

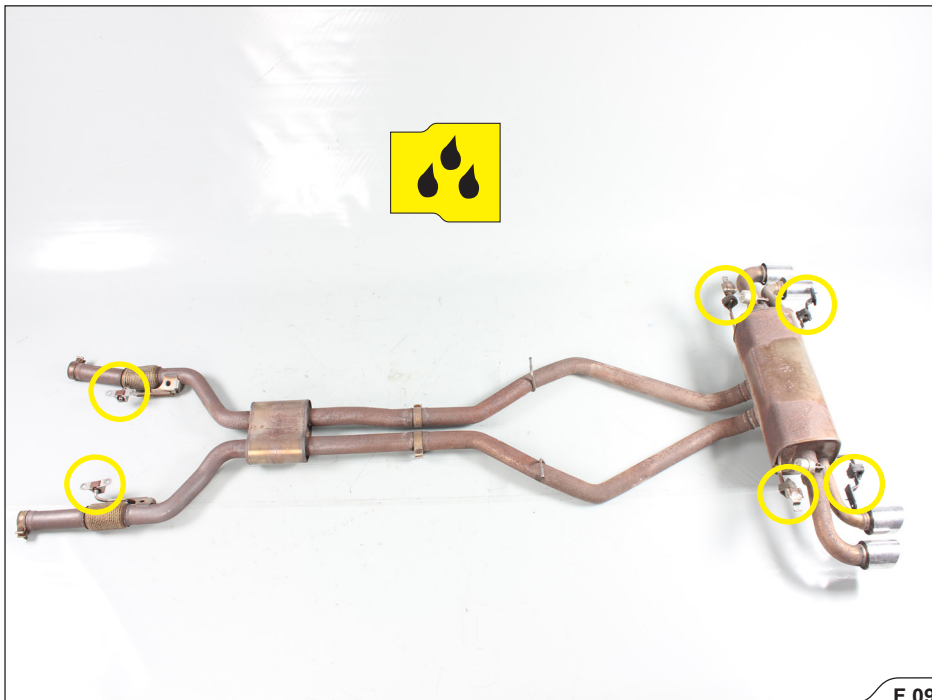

INSTALLATION OF THE AKRAPOVIČ EXHAUST SYSTEM:

1. Assemble the pipes and muffler (using clamps from Akrapovič installation kit), as shown and install stock rubber brackets (F 10, 11, 12).

! IMPORTANT: hand tighten the clamps only!

✂ INSTALLATION TIP: for easier mounting, lubricate the original rubber brackets (WD40®)*.

*WD-40® is a trademark of the WD-40 Company.

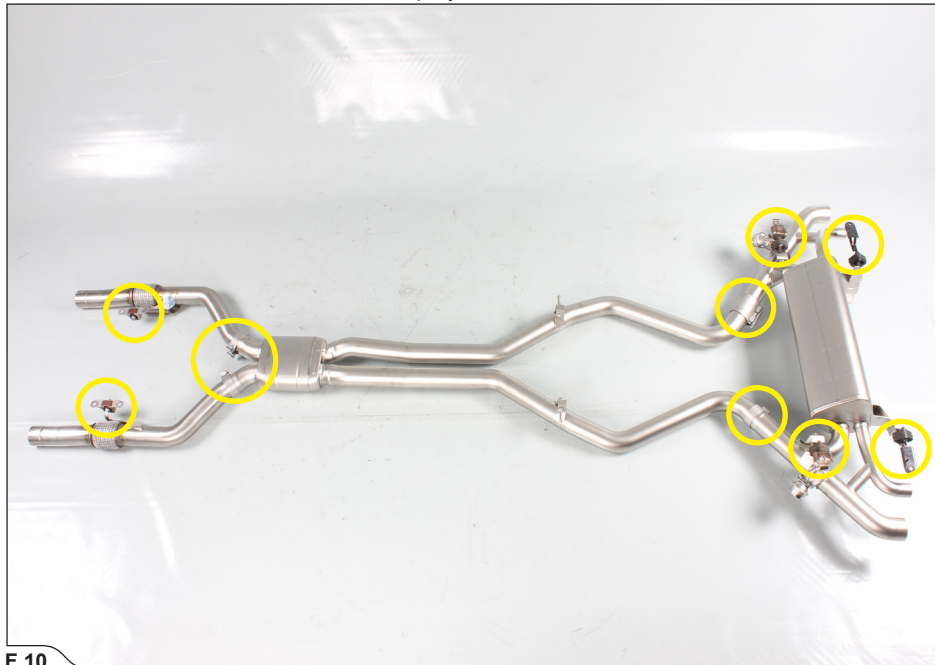

F 10

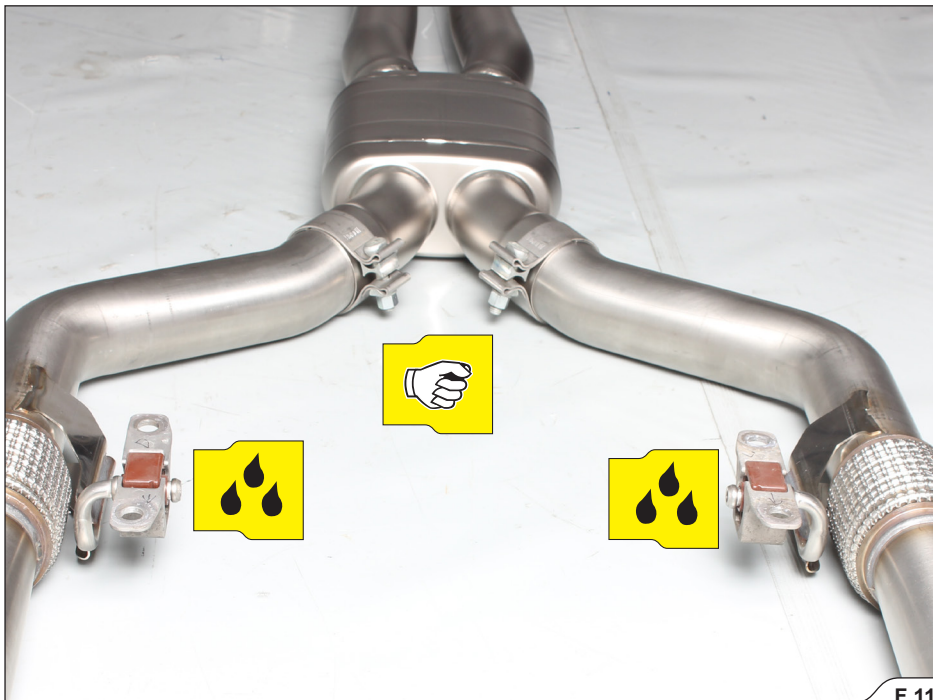

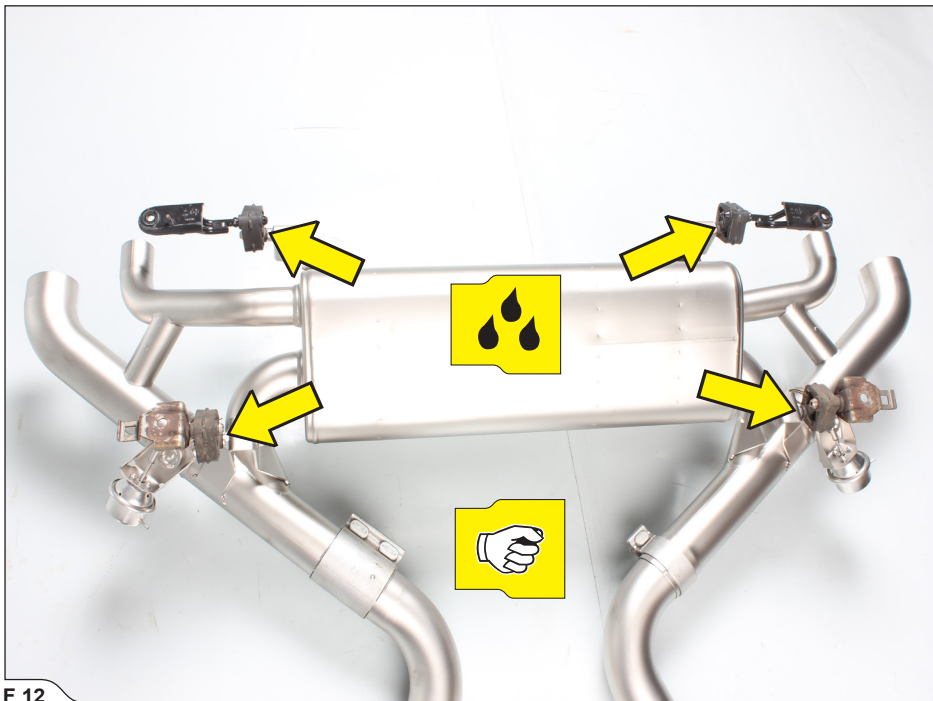

F 12

2. Insert the reduction bushes (Akrapovič installation kit) into the pipes' inlets and install clamps, as shown (F 13).

! **IMPORTANT:** hand tighten the clamps only!

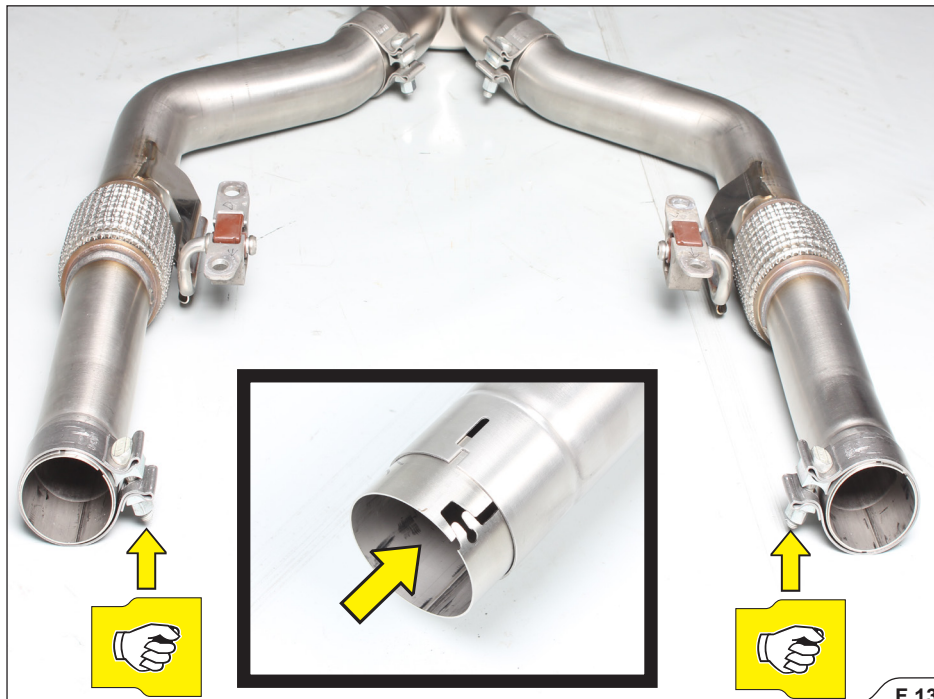

- Carefully install the Akrapovič exhaust system onto the vehicle, tighten the rubber brackets onto the chassis, attach the link pipes' pins into the stock rubber brackets, tighten all muffler's rubber brackets onto the chassis and connect the vacuum tubes onto both actuators (F 14, 15, 16, 17, 18, 19).

! **IMPORTANT:** hand tighten all clamps only!

! **CAUTION:** make sure not to injure yourself or damage the link pipes during this process!

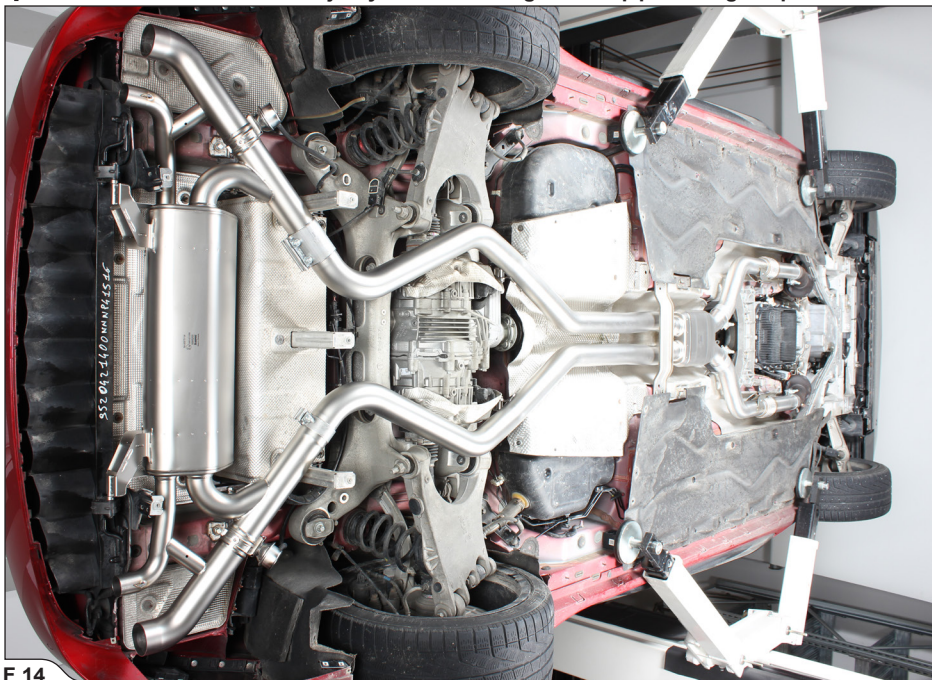

F 14

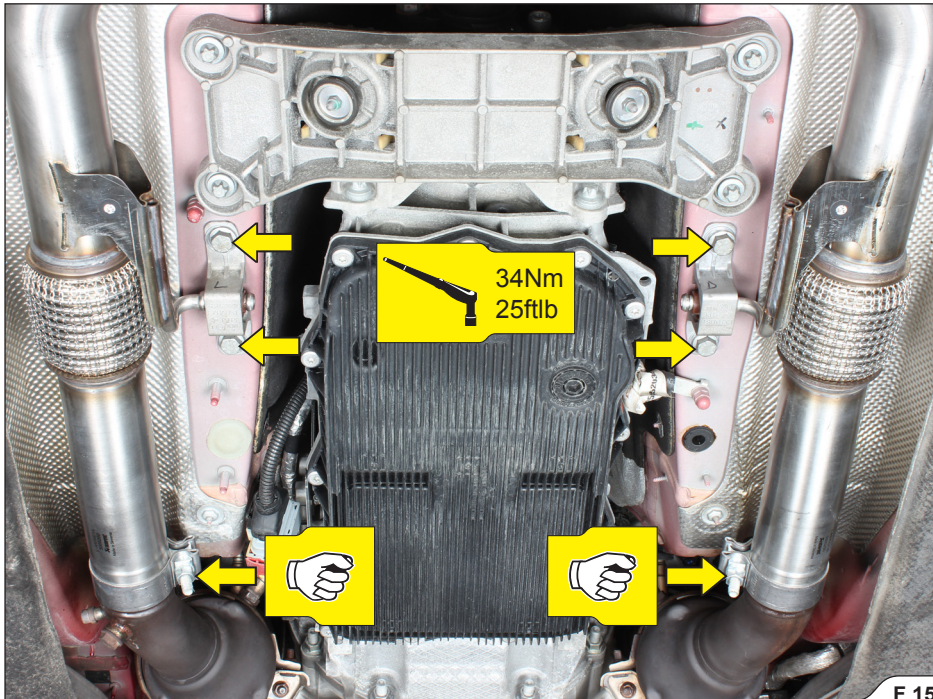

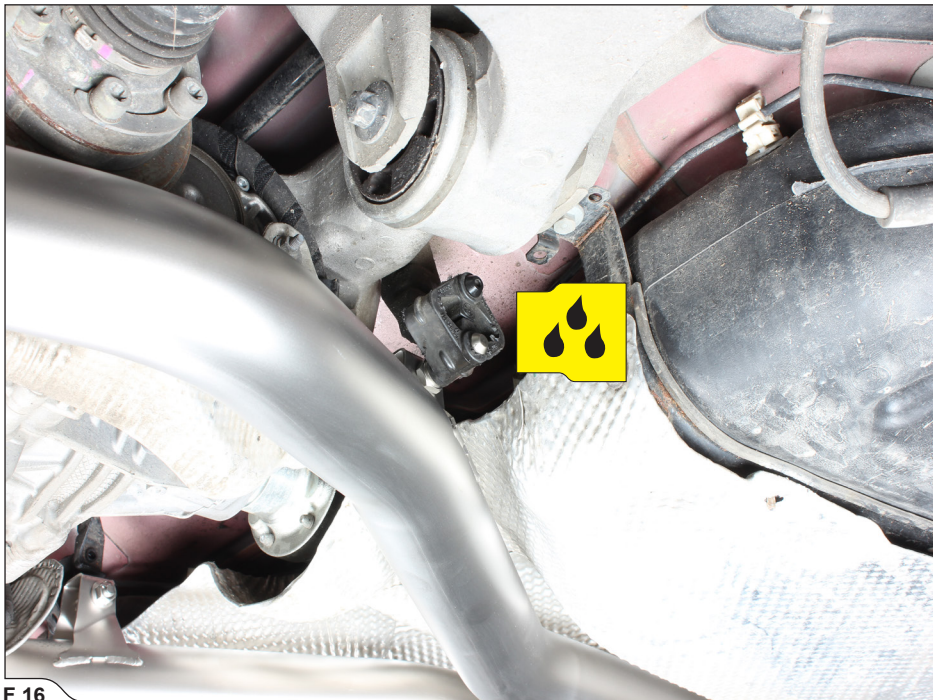

F 16



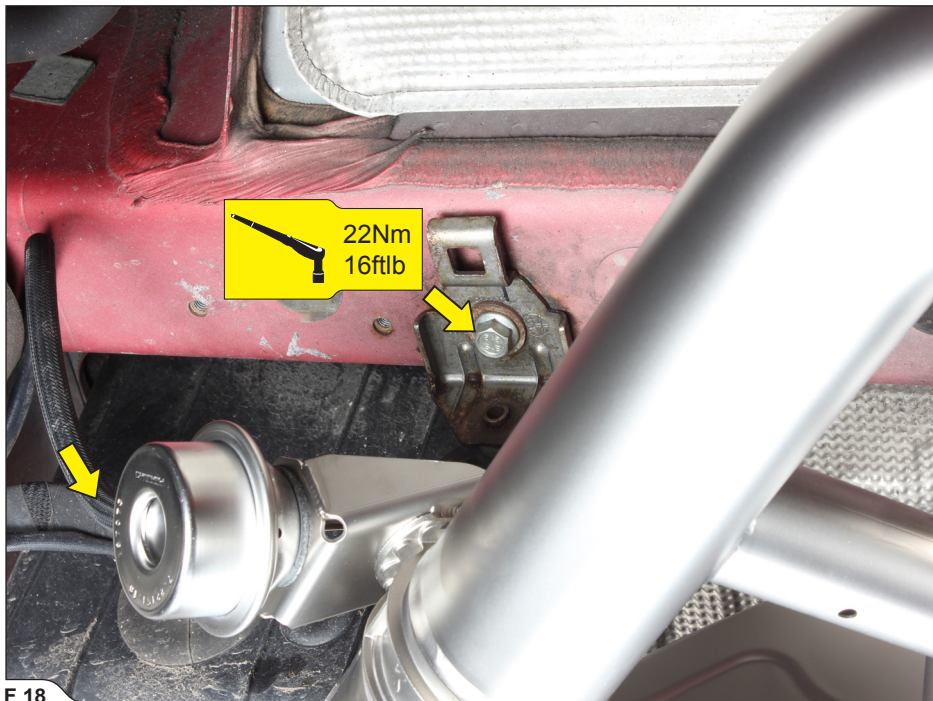

F 18

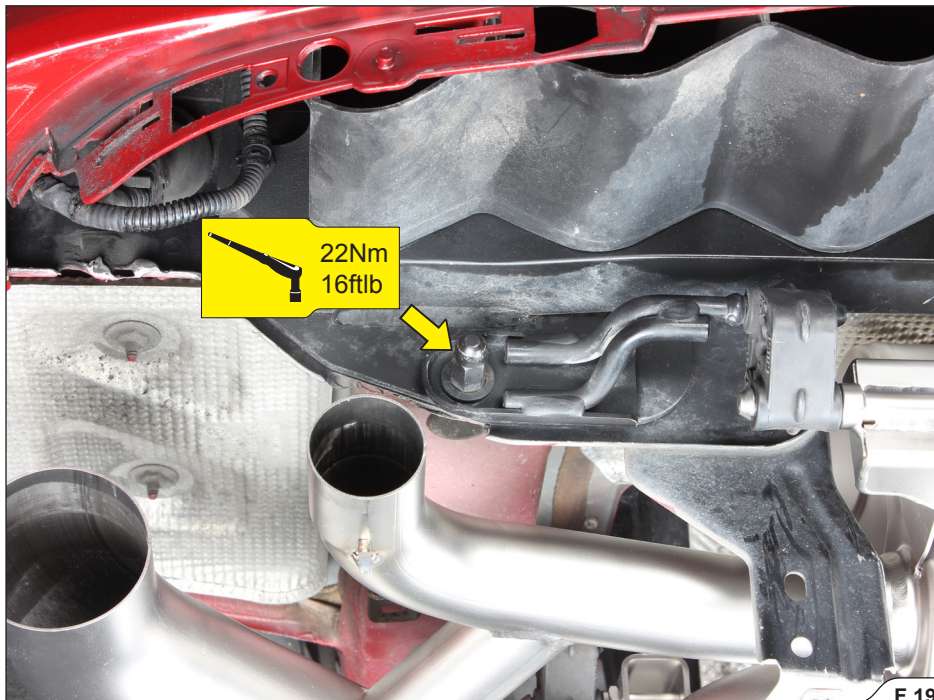

4. Align (lengthwise) the muffler's outlets by adjusting the marked joints and tighten the clamps to the specified torque (**F 20**).

! **CAUTION:** make sure not to injure yourself or damage any part of the vehicle during this process!

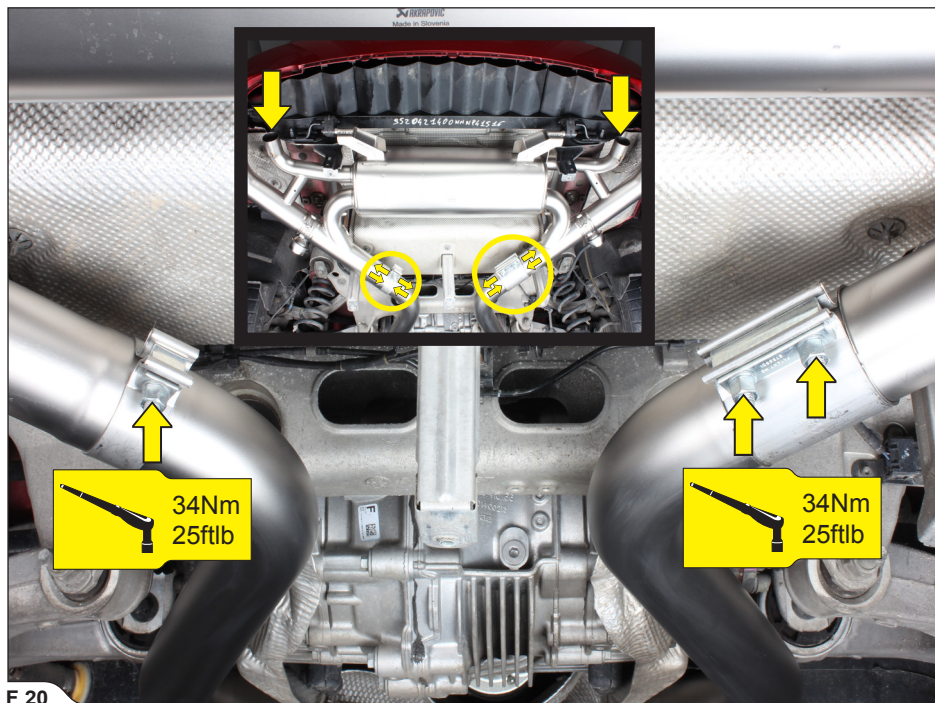

F 20

5. Reinstall the chassis reinforcement (F 21).

! **CAUTION:** make sure not to injure yourself or damage any part of the vehicle during this process!

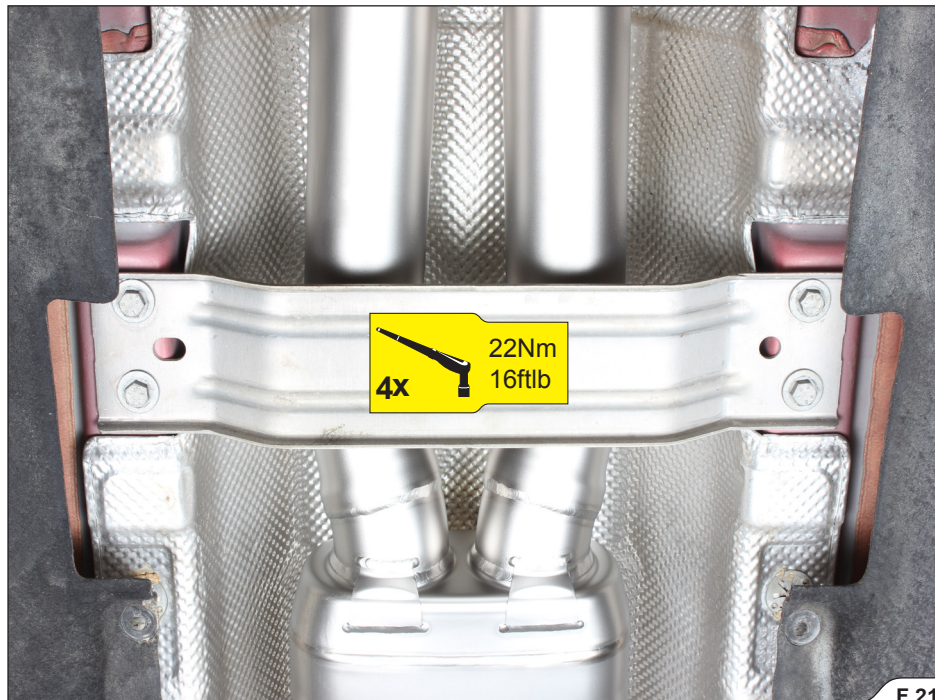

6. By rotating the front pipes, adjust the exhaust system (heightwise), so the middle muffler is in line with chassis reinforcement, then tighten the marked clamps to the specified torque (F 22, 23, 24).

! **CAUTION:** make sure not to injure yourself or damage any part of the vehicle during this process!

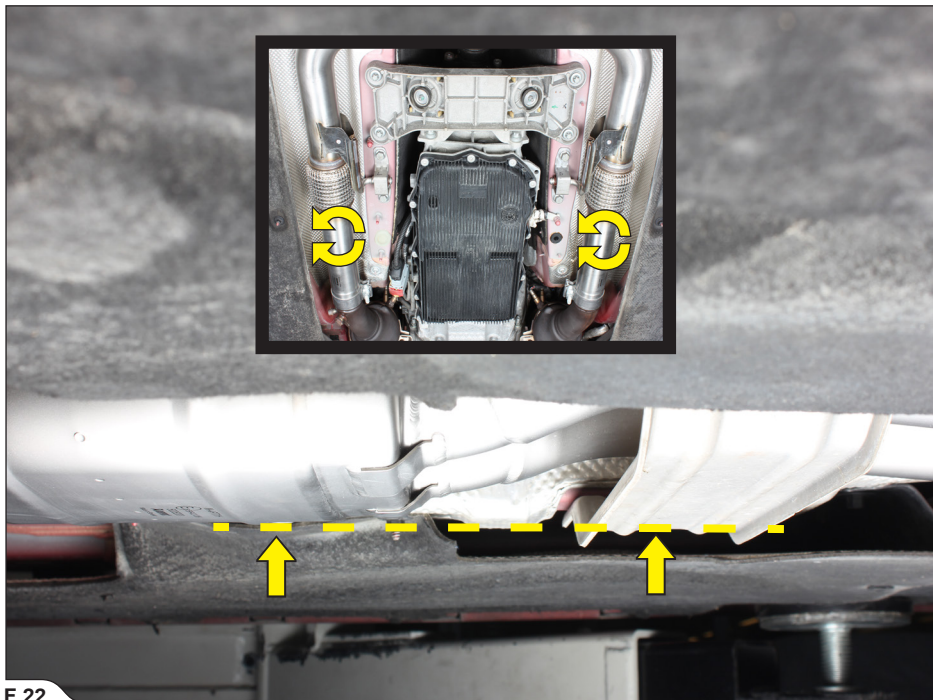

F 22

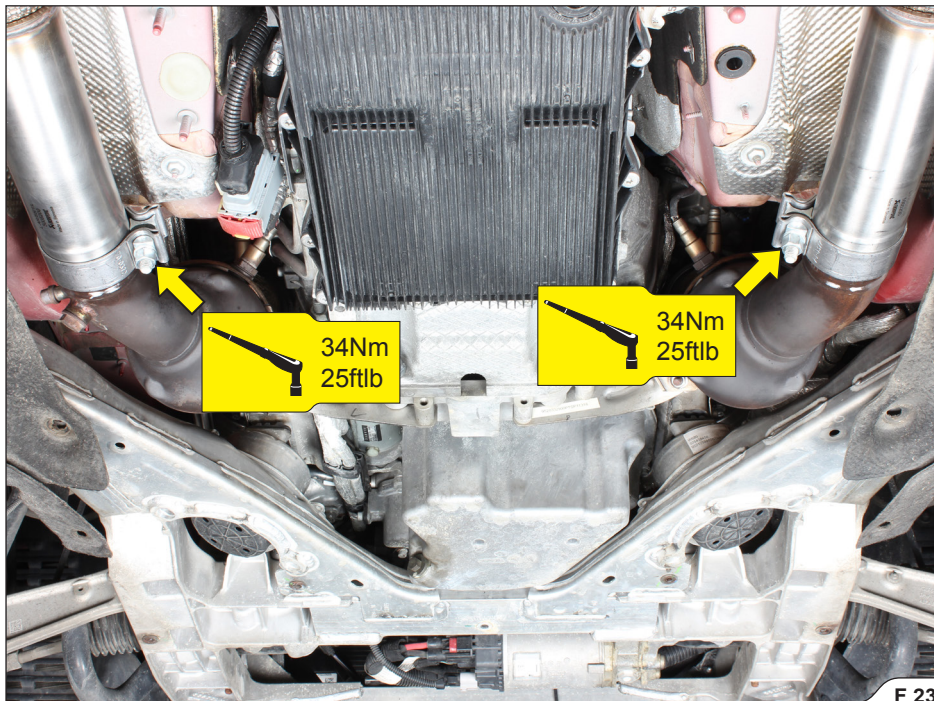

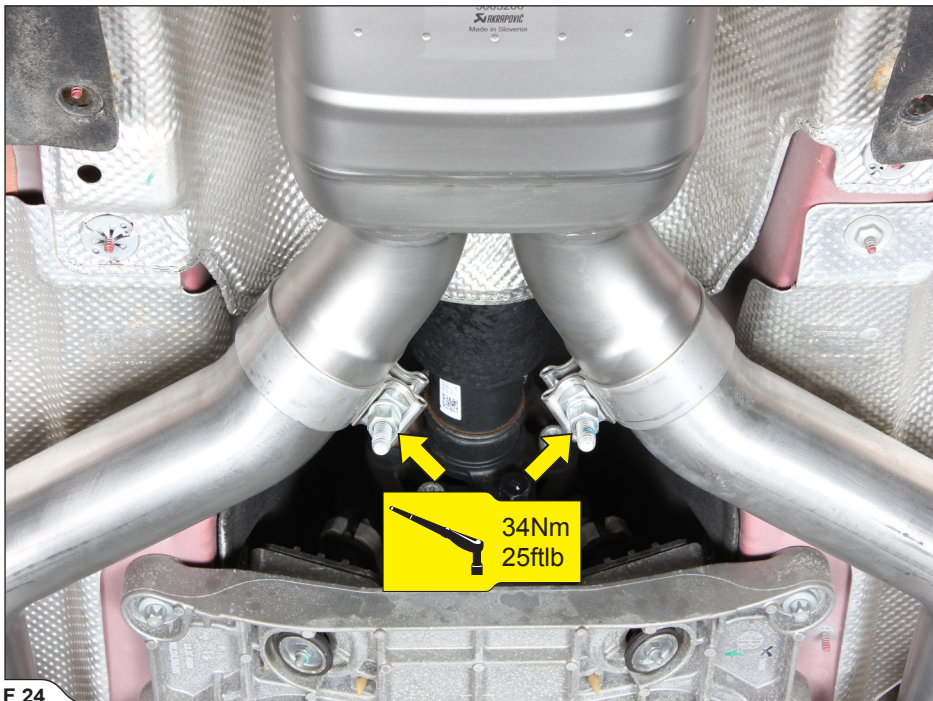

F 24

7. Reinstall the middle and rear under-floor panels; check the vehicle manufacturer workshop manual for correct procedures and tightening torques (F 25).

! CAUTION: make sure not to injure yourself or damage any part of the vehicle during this process!



8. Assemble the tail pipes and slide them onto the muffler outlets. Rotate and center them in respect to rear bumper and according to your personal preference and tighten the clamps to the specified torque (F 26, 27, 28, 29).

! **IMPORTANT:** make sure, not to damage tail pipes, bumper or any part of the vehicle during this process!







F 28

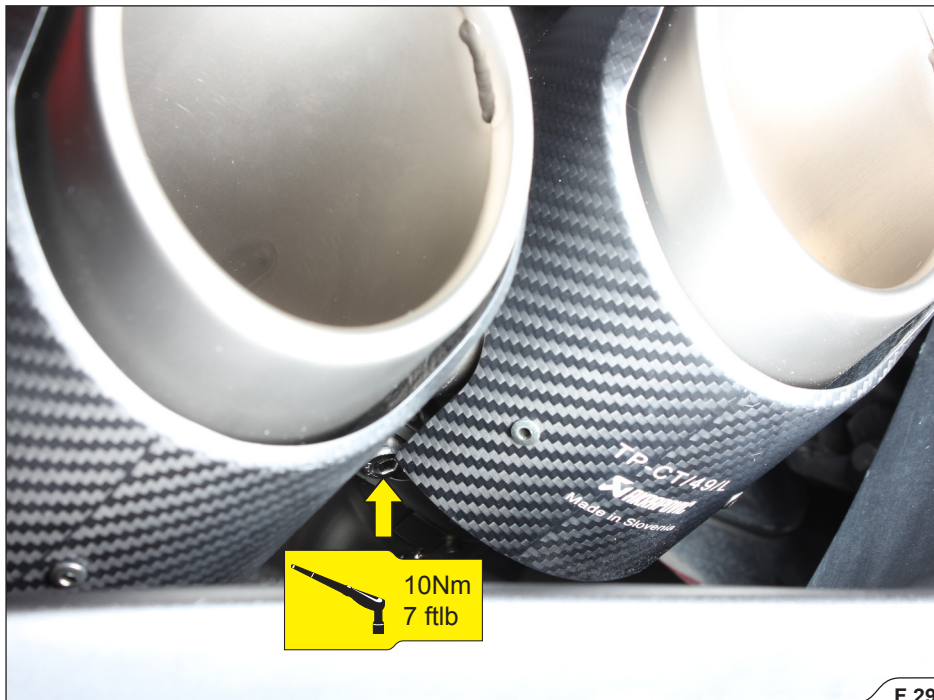

9. Reinstall all dismantled stock parts; check the vehicle manufacturer manual for correct procedures and tightening torques (F 30).

! CAUTION: make sure not to injure yourself or damage any part of the exhaust system during this process!



F 30

FINAL INSTALLATION:

- ! **IMPORTANT:** reinstall the dismantled or partially removed stock parts (wheel arches, bumper etc.); check vehicle manufacturer manual for tightening torques.
- ! **IMPORTANT:** make sure all the nuts and bolts are sufficiently tightened. In case the exhaust system touches the cowling or other parts, repeat the adjustment of the exhaust system or contact your authorized dealer.
- ! **IMPORTANT:** clean all exhaust components before the first start of the engine or the stains will burn onto the surfaces!

MAINTENANCE OF THE AKRAPOVIČ EXHAUST SYSTEM:

1. Clean the titanium exhaust components with a multi-purpose spray lubricant (WD-40[®] or equivalent)*, carbon fiber exhaust components with soft and dry cloth and stainless steel components with soft cloth sprayed with contact cleaner, then wipe with soft and dry cloth. A change in the color of the exhaust system is normal due to high temperatures.
2. Periodically make sure all the bolts and springs are sufficiently tight.

*WD-40[®] is a trademark of the WD-40 Company.



INSTALLATION TIP: IT IS NORMAL FOR WHITE SMOKE TO COME OUT OF THE MUFFLER AT FIRST OPERATION.

- ! **CAUTION: DO NOT STAND BEHIND THE MUFFLER AT ANY TIME.**
- ! **CAUTION: DO NOT USE AUTOMOTIVE WHEEL CLEANERS OR ANY CLEANING PRODUCTS WHICH CONTAIN ACIDIC ADDITIVES TO CLEAN THE AKRAPOVIČ EXHAUST SYSTEMS.**

WARNING: THE EXHAUST SYSTEM CAN BE EXTREMELY HOT. ALLOW THE EXHAUST AND ENGINE TO COOL DOWN BEFORE BEGINNING INSTALLATION OR ANY OTHER WORK ON THE EXHAUST SYSTEM. THIS MANUAL IS SPECIFIC TO THE ALFA ROMEO GIULIA QUADRIFOGLIO TYPE 952. THERE MAY BE SOME DIFFERENCES IN INSTALLATION PROCEDURES FOR OTHER MODELS.

TROUBLESHOOTING:

Problem	Possible cause	Solution
Exhaust gas leaks out of the muffler/pipe clamp connections	loosened clamp	tighten the clamp to specified torque
	connection is not completely joined	tap the connection into place and tighten the clamp to specified torque