

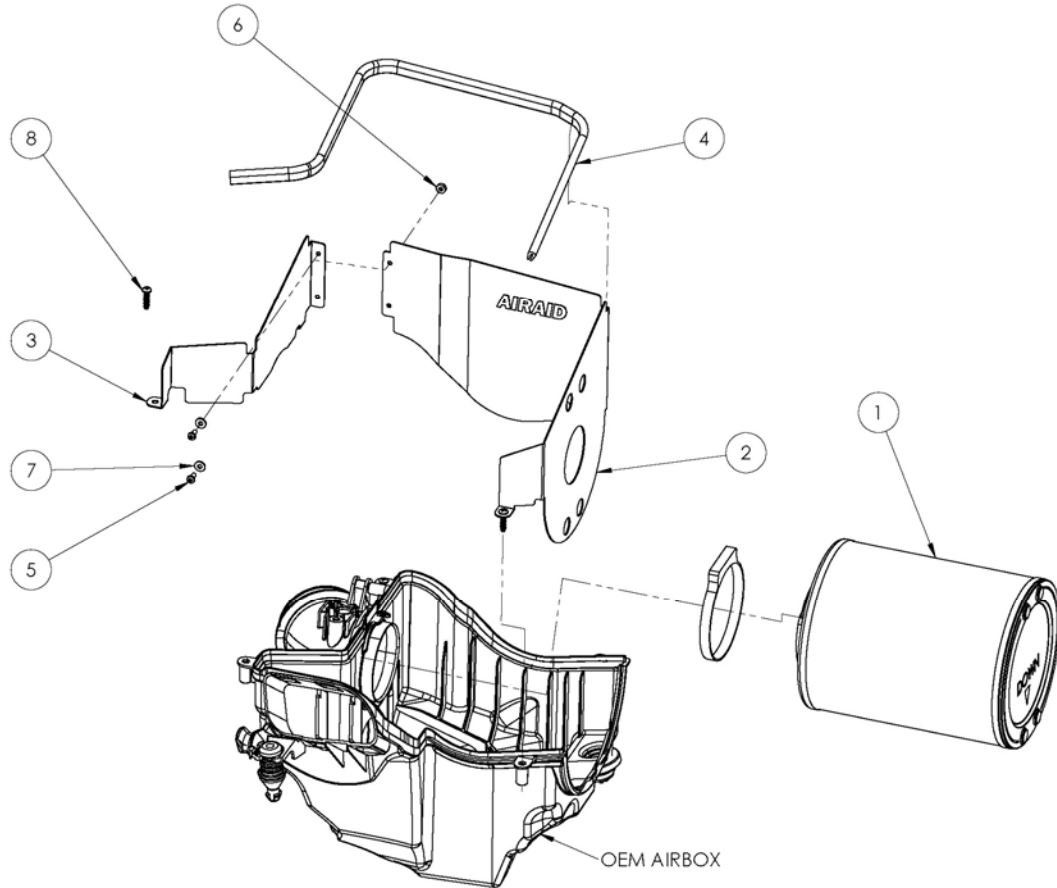

Installation Instructions

For Part Numbers:

- 450-300 860-408 Airaid Oiled Media Filter
- 451-300 861-408 SynthaMax Dry Media Filter - Red
- 452-300 862-408 SynthaMax Dry Media Filter - Black
- 453-300 863-408 SynthaMax Dry Media Filter - Blue
- 2013-16 Ford Escape 1.6 and 2.0L
- 2017 Ford Escape 2.0L
- 2015-17 Lincoln MKC 2.0 and 2.3L



Component Identification

1.AIR-86/861/862/863-408	Airaid Filter	1
2.AIR-KIT181RPC	Right Panel	1
3.AIR-KIT181LPC	Left Panel	1
4.AIR-KITX1012	Edge Trim	1
5.AIR-KIT6C31MXPPZ	#6-32 x 5/16 PH Screw	2
6.AIR-KIT6CNKEPZ	#6-32 Kep Nut	2
7.AIR-KIT6NWSAPZ	#6 Flat Washer	2
8.AIR-KIT10PPHL34SS	#10 Plastic Screw	4

Please read these installation instructions in their entirety before beginning the install process.



1. NOTE: Airaid recommends allowing sufficient time for a complete engine cool down before performing this installation.



2. Locate battery cover and remove it. Disconnect the Negative terminal.

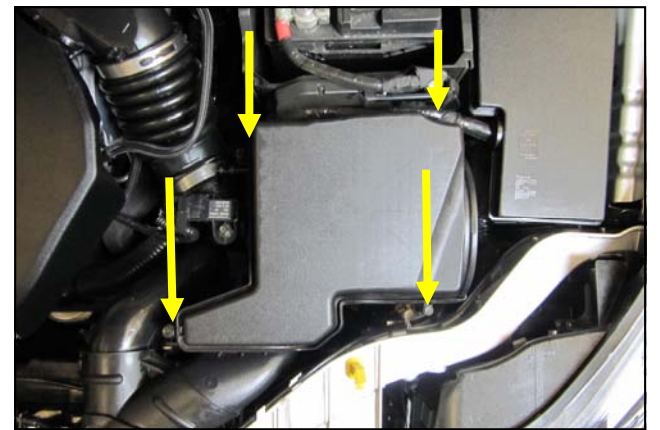

3. Remove the four airbox screws and the airbox lid.

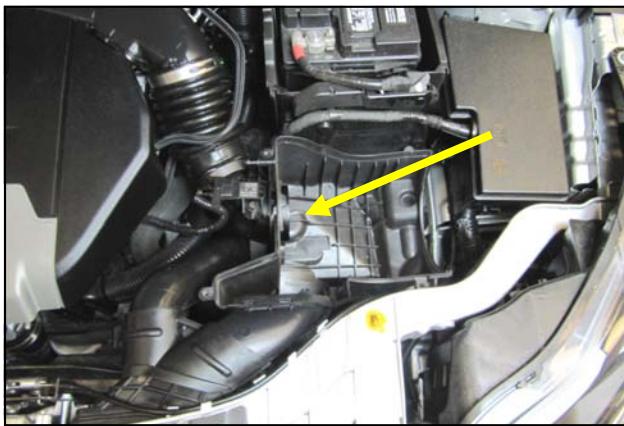

4. Notice how the OEM filter is installed in the air box . Remove the factory air filter and examine the mounting tube inside the air box.

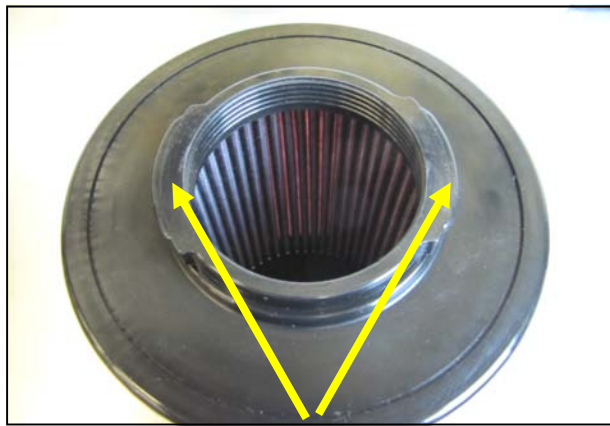

5. Notice that the Airaid Filter is designed to mate perfectly with the features on the air box mounting tube



6. Notice that the Airaid Filter top has a directional arrow in the center and locating lugs in the 12:00 and 6:00 positions.



7. Install The Airaid Premium Filter (#1) and clamp into the air box as shown, with the Arrow pointing Down and the Lugs in the correct position. When properly installed, the Filter top will be completely inside of the airbox lower half.

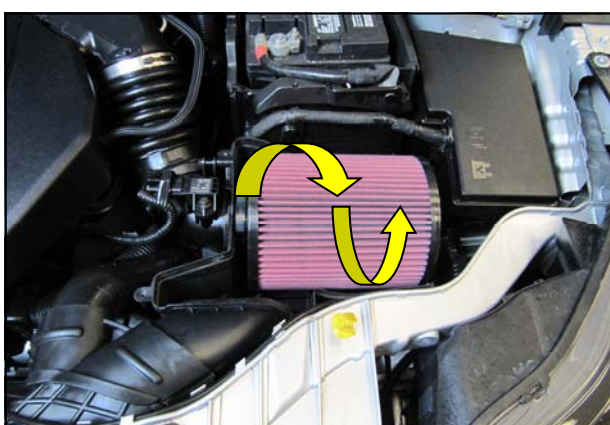

8. Rotate the Filter forwards and backwards a few degrees to ensure it has positively engaged the mounting tube. Do not tighten the clamp at this time.

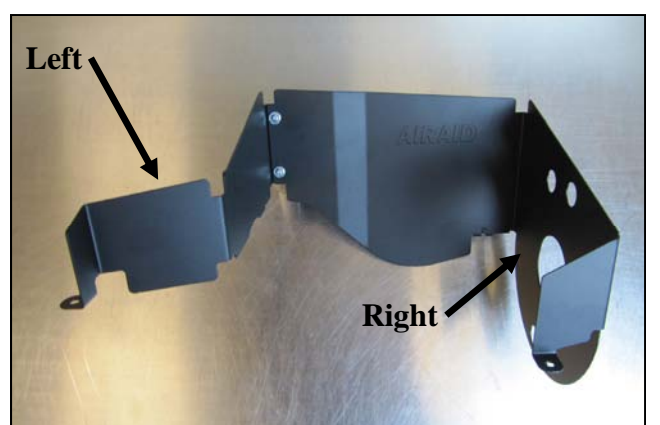

9. Create the Panel assembly as shown using the Right and Left panels (#2&3) and the set of 6-32 Screws, Nuts, and washers (#'s 5, 6 & 7).

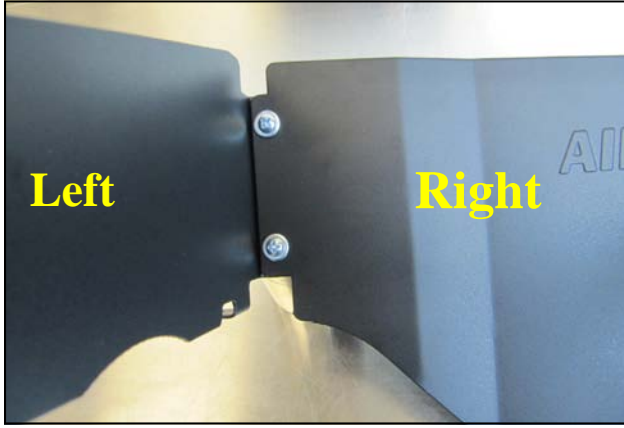

10. Note: When properly installed the Tab of the Left Panel is behind the Right Panel.

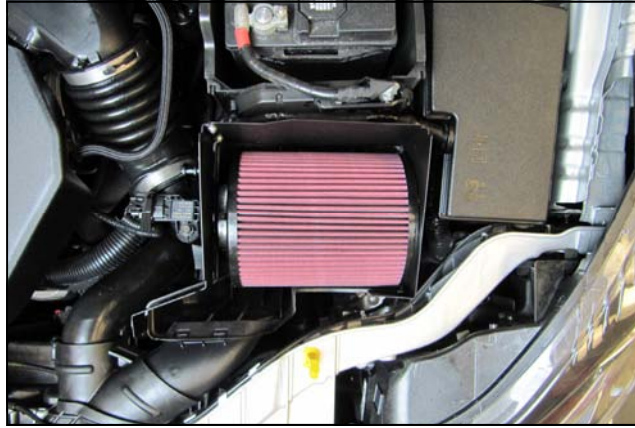

11. Set the Panel assembly into the factory air box .

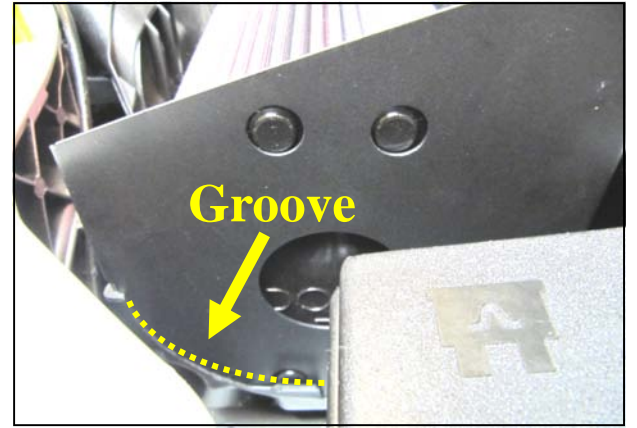

12. When properly installed, the panel will reside inside the groove in the air box and both sets of locating lugs will positively engage the holes in the Panel.

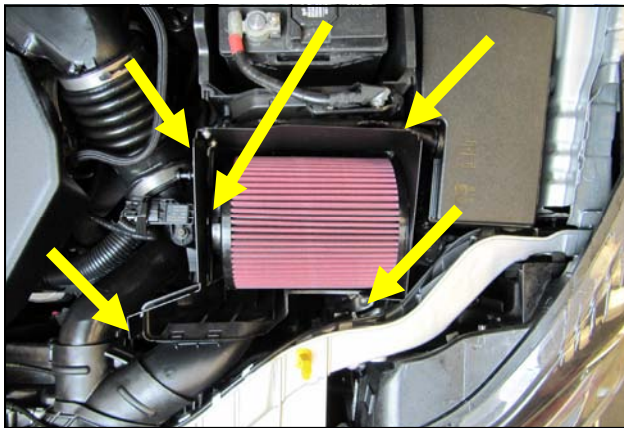

13. Secure the panel assembly to the airbox using the four # 10 Plastic Screws (#8). Hint: A magnetic tipped #2 Phillips head screwdriver works best. Tighten the Air Filter clamp at this time.



14. Install the Edge Trim (#4) onto the top edge of the Panel assembly.

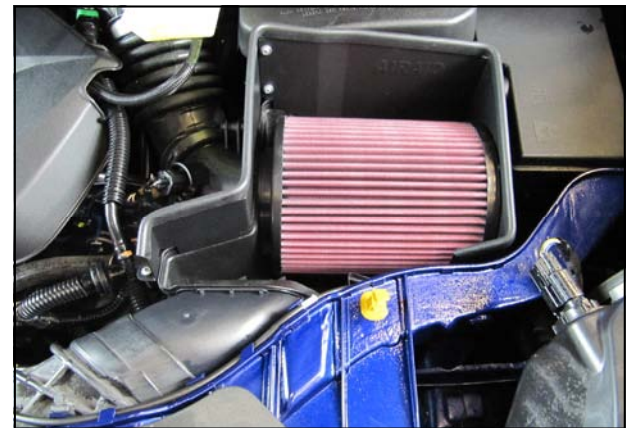

15. Re connect the battery terminal and reinstall the cover.

Double check your work!

Make sure there is no foreign material in the intake path. Make sure all clamps, hoses, bolts, and screws are tight. Double check the hood clearance!

Thank you for purchasing the Airaid Intake System. Your Airaid Intake System was carefully inspected and packaged. Check that no parts are missing, or were damaged during shipping. If any parts are missing, contact Airaid.

The air filter element is protected from direct exposure to water and debris; care should be taken not to drive through deep water. **WA-TER INGESTION IS THE DRIVERS RESPONSIBILITY!** The air filter is reusable and should be cleaned periodically.

FILTER IDENTIFICATION

860-408 Airaid Oiled Media
862-408 Airaid SynthaMax Dry Media - Black

861-408 Airaid SynthaMax Dry Media - Red
863-408 Airaid SynthaMax Dry Media - Blue

For your Oiled media filter we suggest using the AIRAID Filter Tune-Up Kit!



P/N 790-551 Aerosol Spray
P/N 790-550 Squeeze Spray



SynthaMax

Do Not Oil

Synthamax Air Filters do not require oil. Service air filter as needed by cleaning with common non-petroleum all-purpose household cleaner and water. Simple Green®, Formula 409® or equivalent works great. Apply cleaner to outside of air filter and allow to soak. Then flush filter clean from the inside out with a garden hose and repeat steps if necessary. Do not apply high pressure water or air to clean filter. Allow filter to air dry and reinstall.