



Installation Instructions

For Part Numbers:

- 400-239-1 720-478 Airaid Oiled Media Filter
- 401-239-1 721-478 SynthaMax Dry Media Filter - Red
- 402-239-1 722-478 SynthaMax Dry Media Filter - Black
- 403-239-1 723-478 SynthaMax Dry Media Filter - Blue

2011-14 Ford F-150 3.5L, 3.7L and 5.0L Motors
 2010-14 Ford SVT Raptor 6.2L
 2011-16 Ford F-250/ 350 Superduty 6.2L

INTAKE SYSTEMS FOR VEHICLES LISTED ARE 50 STATE LEGAL. SEE CARB STATUS ON EACH PART FOR A SPECIFIC VEHICLE.

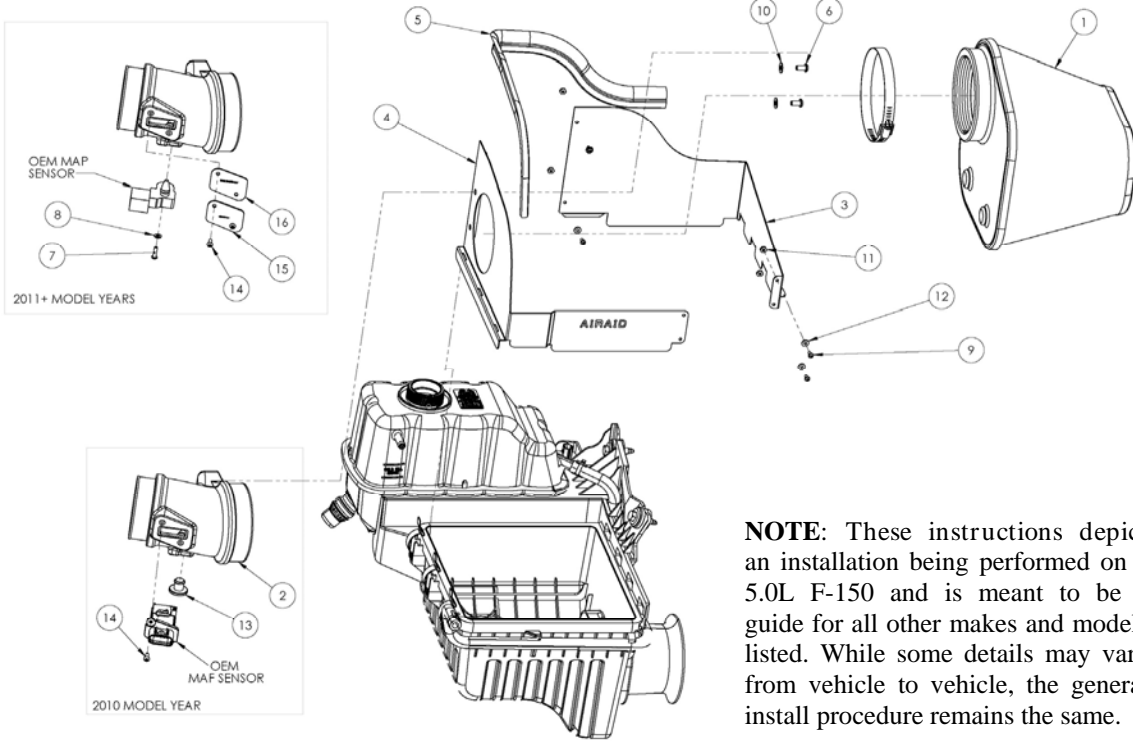

NOTE: These instructions depict an installation being performed on a 5.0L F-150 and is meant to be a guide for all other makes and models listed. While some details may vary from vehicle to vehicle, the general install procedure remains the same.

Component Identification

1	AIRAID Premium Filter	1
1	Airaid Intake Tube	1
1	Rear Panel	1
1	Front Panel	1
1	Weather Strip, 22"	1
1	1/4-20 Button Head Screw	2
1	8-32 x 3/4" Button Head Screw	1
1	#8 Flat Washer	1
1	6-32 x 5/16" Phillips Head Screw	4
1	1/4" Flat Washer	2
1	6-32 Kep Nut	4
1	#6 Flat Washer	4
1	MAP Plug	1
1	1/2" Button Head Screw	2
1	MAF Cap	1
1	MAF Cap Gasket	1
17	Torx Bit	1
18	Airaid Decal	1

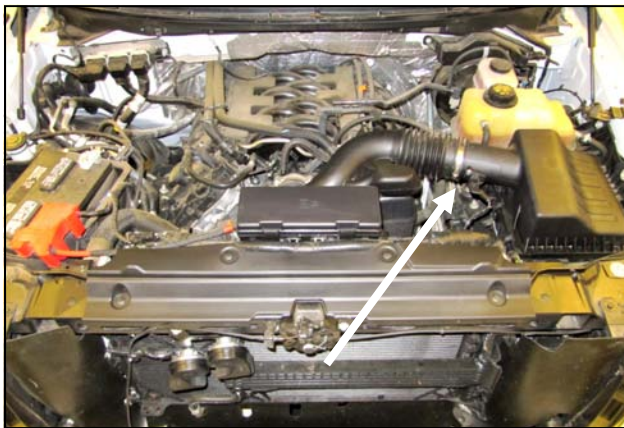

Disconnect The Negative Battery Terminal!

1. Loosen the hose clamp on the airbox side of the factory air intake tube.

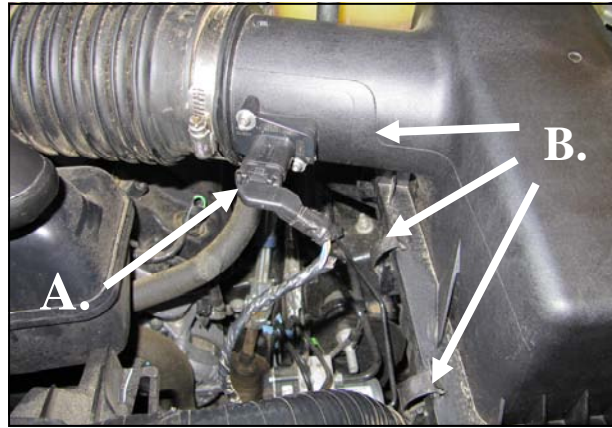

2. **A.** Disconnect the sensor, MAF or MAP, in the factory airbox top.
B. Unfasten the Three clips on the left side of the air-box.



3. Slide the factory intake away from the airbox. Lift up and slide the airbox tabs out of the slots in the lower half and set aside.



4. Remove the Factory air filter.

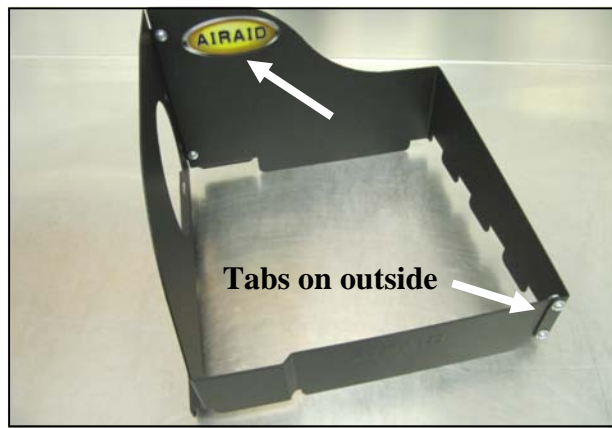

5. Assemble the Front and Rear Panels as shown with the tabs on the outside of the assembly. Use the four 6-32 Phillips Head Screws, #6 Flat Washers, and #6 Kep Nuts to secure the assembly. Apply the Airaid Decal on the completed Panel assembly as shown.

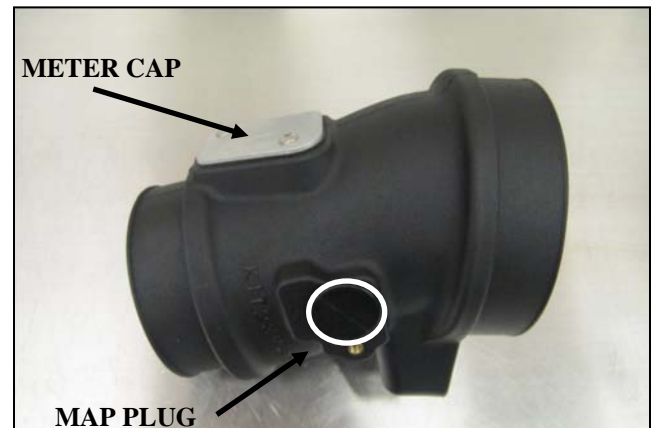

6. Depending on the sensor configuration of your factory intake system, you will use one of the two sensor receptacles in the Airaid intake tube. There is a Mass Airflow sensor receptacle on the tube and a MAP sensor receptacle on the tube.



7. **If your vehicles intake utilizes a MAP sensor:** Install the Meter Cap and Gasket onto the Airaid Intake tube as shown, using the two 8-32 1/2" Button Head Screws.

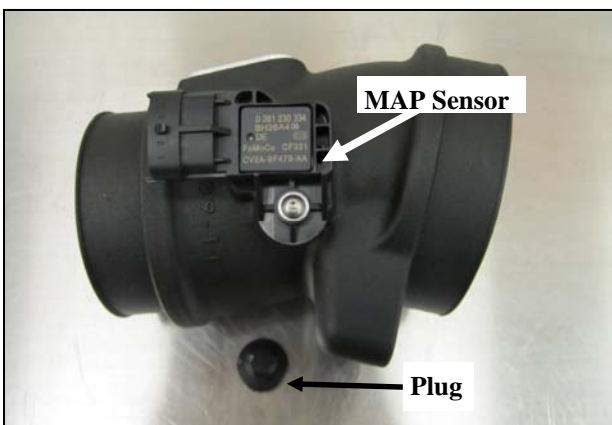

8. Transfer the MAP Sensor into the Airaid intake tube as shown. Secure the sensor using the Long 8-32 Button Head Screw and the Washer. Discard the Plug. It will not be used.

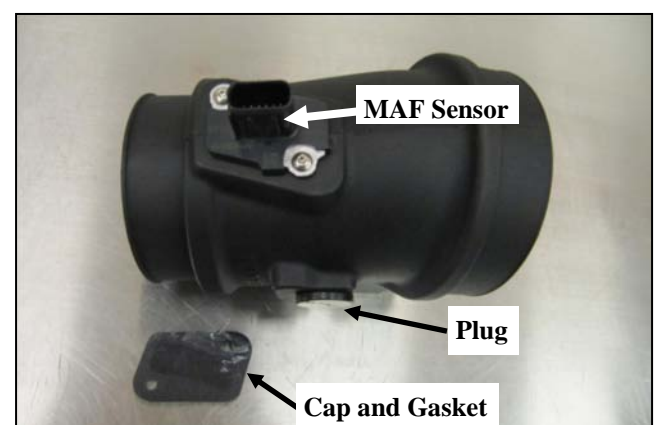

9. **If your vehicles intake utilizes a Mass Airflow, or MAF sensor:** Transfer the sensor into the Airaid intake tube as shown and secure using the two 1/2" Button Head Screws. Complete the Tube assembly by inserting the MAP Plug. Discard the Meter Cap and Gasket. They will not be used.



10. Install the Air Meter Tube into the Panel Assembly and secure using the two 1/4-20 Button Head Screws ,and 1/4" Flat Washers .

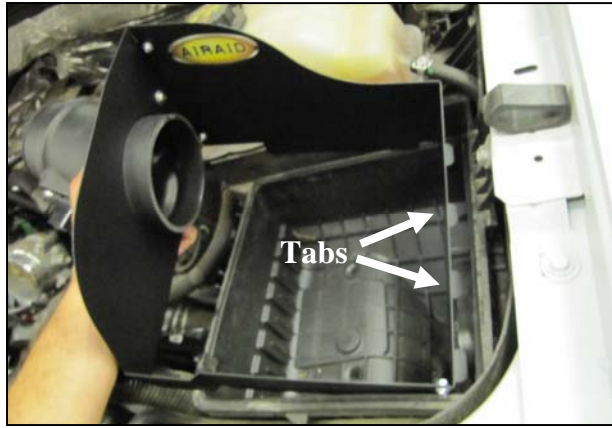

11. Install the Airaid intake assembly onto the factory airbox bottom. Insert the Panel tabs into the slots first, then lower the tube side down and fasten the three clips.



12. Slide the factory intake tube onto the Airaid Tube and tighten the clamp. Reconnect the Mass Air Flow or MAP sensor.



13. Install the Weather Strip to the Panel assembly as shown, with the contour rolling away from the filter area.



14. Install the Airaid Premium Filter on to the Air Meter Tube and tighten the clamp.

14. Double check your work!

Make sure there is no foreign material in the intake path. Make sure all clamps, hoses, bolts, and screws are tight. Double check the hood clearance!

Reconnect the negative battery cable!

Thank you for purchasing the Airaid Intake System. Your Airaid Intake System was carefully inspected and packaged. Check that no parts are missing, or were damaged during shipping. If any parts are missing, contact Airaid. The air filter element is protected from direct exposure to wa-ter and debris; care should be taken not to drive through deep water. WATER INGESTION IS THE DRIVERS RESPONSIBILITY! The air filter is reusable and should be cleaned periodically.

FILTER IDENTIFICATION

720-478 Airaid Oiled Media
722-478 Airaid SynthaMax Dry Media - Black

721-478 Airaid SynthaMax Dry Media - Red
723-478 Airaid SynthaMax Dry Media - Blue

For your Oiled media filter we suggest using the AIRAID Filter Tune-Up Kit!



Do Not Oil



Synthamax Air Filters do not require oil. Service air filter as needed by cleaning with common non-petroleum all-purpose household cleaner and water. Simple Green®, Formula 409® or equivalent works great. Apply cleaner to outside of air filter and allow to soak. Then flush filter clean from the inside out with a garden hose and repeat steps if necessary. Do not apply high pressure water or air to clean filter. Allow filter to air dry and reinstall.

**P/N 790-551 Aerosol Spray
P/N 790-550 Squeeze Spray**