



## Installation Instructions

For Part Numbers:

400-214-1	720-472 Airaid Oiled Media Filter
401-214-1	721-472 SynthMax Dry Media Filter - Red
402-214-1	722-472 SynthMax Dry Media Filter - Black
403-214-1	723-472 SynthMax Dry Media Filter - Blue

2008-10 Ford F-250 Thru F-550 Super Duty  
6.4L V8 Power Stroke

**INTAKE SYSTEMS FOR VEHICLES LISTED ARE 50 STATE LEGAL. SEE CARB STATUS ON EACH PART FOR A SPECIFIC VEHICLE.**

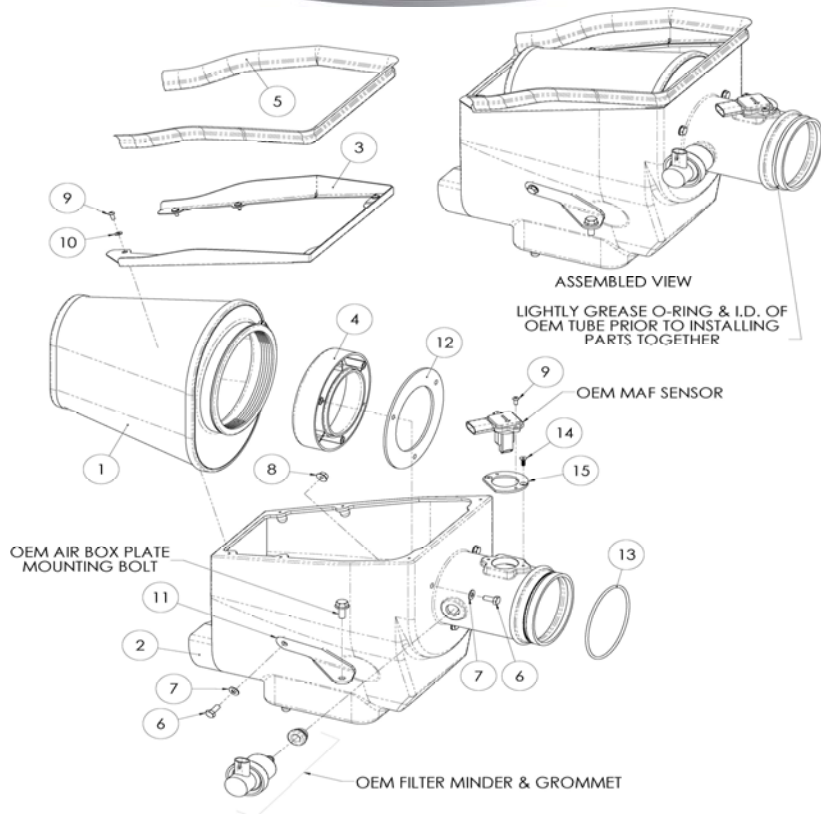

## Component Identification

1.	Airaid Premium Filter	1
2.	Airaid Cool Air Box	1
3.	Top Panel	1
4.	Filter Adapter	1
5.	Weather Strip 33 1/4"	1
6.	1/4-20x5/8" Hex Bolt	4
7.	1/4" Flat Washer	4
8.	1/4-20 Serrated Nut	1
9.	8-32x3/8" Button Head Bolt	8
10.	#8 Flat Washer	6
11.	Bracket	1
12.	Adapter Gasket	1
13.	1/8" x 4" O-Ring	1
14.	8-32x1/2" Flat Head Screw	2
15.	Calibration Plate	1
16.	T20 Torx Security Bit	1
17.	O-Ring Grease	1

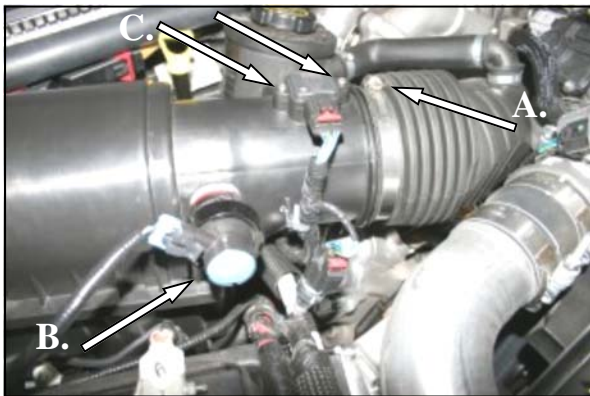

### 1. Disconnect the negative battery cables.

**A)** Loosen the hose clamp that holds the intake tube to the airbox. **B)** Disconnect the filter minder wiring harness, and then remove the factory filter minder and grommet from the intake tube (save for reuse). **C)** Disconnect the Mass Air Flow (MAF) sensor wiring harness. Using the supplied Torx bit, remove the two screws, and the (MAF) sensor from the factory airbox. Save the MAF sensor for reinstallation in step #10.



**2.** Remove the factory airbox and tube from the vehicle as an assembly, by pulling straight up on the box. It is only held in place by grommets, no bolts.



**3.** Remove one bolt from the factory airbox mounting plate, and save it for reinstallation in step #8.

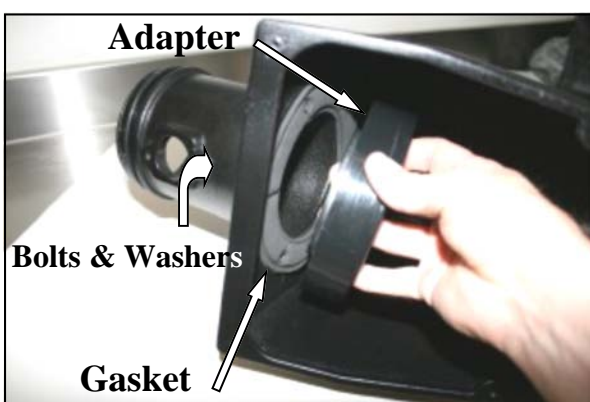

**4.** Install the adapter gasket (#12), and filter adapter (#4) into the Airaid Cool Air Box (#2) using three 1/4-20x5/8" hex bolts (#6), and 1/4" flat washers (#7).

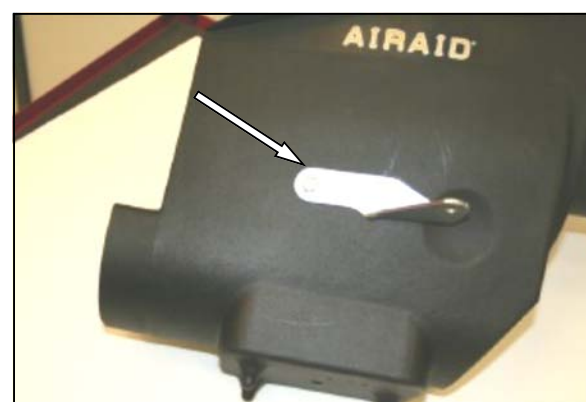

**5.** Install the bracket (#11) using one 1/4-20x5/8" hex bolt (#6), 1/4" flat washer (#7), and 1/4-20 serrated nut (#8) as shown. Just snug the bolt for now, it will need to be adjusted in step #8.



**6.** Install the O-ring (#17) into the groove on the Cool Air Box as shown. Apply a *light* coat of the supplied grease onto the O-ring.



**7.** Apply a *light* coat of the supplied grease onto the inside of the factory tube. Install the Airaid Cool Air Box into the vehicle making sure it is seated correctly into the factory grommets, and the inlet is aligned with the factory hole in the fender. Slide the factory intake tube over the O-ring and then tighten the factory hose clamp.

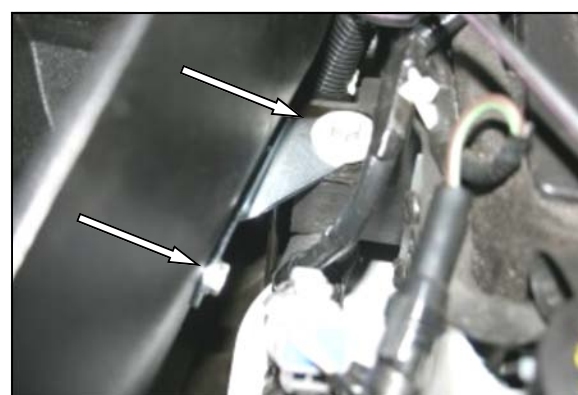

**8.** Reinstall the factory bolt that was removed in step #3, through the bracket that is bolted onto the side of the Cool Air Box. Adjust the box for fit, and tighten both bolts.

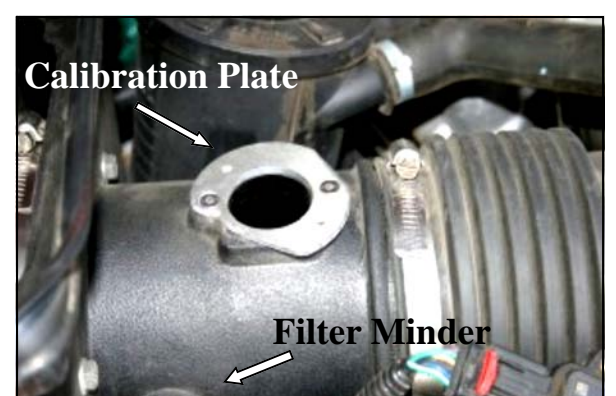

**9. A.)** Install the Calibration Plate onto the Cool Air Box using two 8-32 x 1/2" Flat Head Screws (#14). **B.)** Reinstall the factory grommet, and filter minder into the Cool Air Box, and then reconnect the filter minder wiring harness.



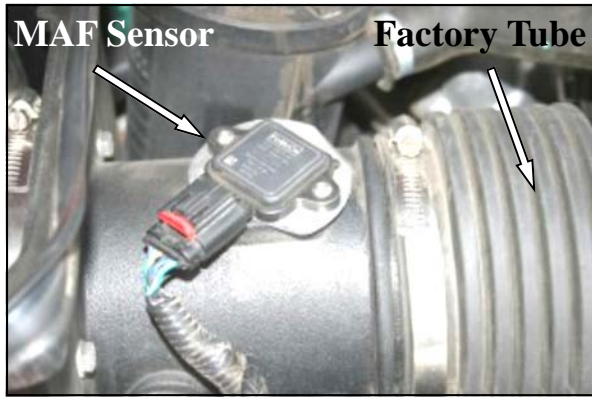

**10.** Install the MAF sensor into the Calibration Plate on the Cool Air Box using two 8-3/8" button head bolts (#9), as shown. Reconnect the MAF sensor wiring harness.

**Do Not Use The Factory Screws**

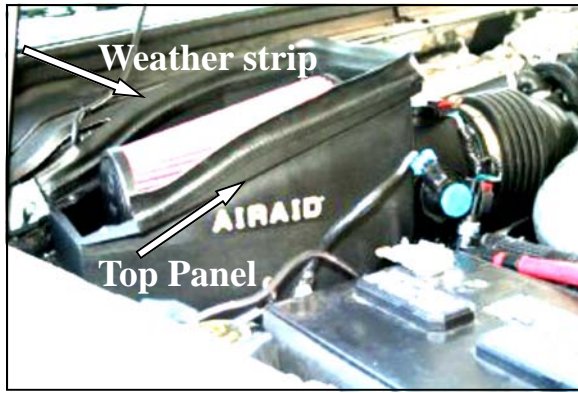

**11.** Install the Airaid Premium Filter (#1) onto the filter adapter, and tighten the hose clamp. Next install the Top Panel (#3) onto the top of the Cool Air Box using six 8-32x3/8" button head bolts (#9), and #8 flat washers (#10). Install the weather strip (#5) onto the edge of the top panel as shown

**12. Double check your work!**

Make sure there is no foreign material in the intake path. Make sure all clamps, hoses, bolts, and screws are tight.

**13. Reconnect the negative battery cables!**

Thank you for purchasing the Airaid Intake System. Your Airaid Intake System was carefully inspected and packaged. Check that no parts are missing, or were damaged during shipping. If any parts are missing, contact Airaid. The air filter element is protected from direct exposure to water and debris; care should be taken not to drive through deep water. **WA-TER INGESTION IS THE DRIVERS RESPONSIBILITY!** The air filter is reusable and should be cleaned periodically.

**FILTER IDENTIFICATION**

720-472 Airaid Oiled Media  
722-472 Airaid SynthaMax Dry Media - Black

721-472 Airaid SynthaMax Dry Media - Red  
723-472 Airaid SynthaMax Dry Media - Blue

**For your Oiled media filter we suggest using the AIRAID Filter Tune-Up Kit!**



P/N 790-551 Aerosol Spray  
P/N 790-550 Squeeze Spray



**Do Not Oil**

Synthamax Air Filters do not require oil. Service air filter as needed by cleaning with common non-petroleum all-purpose household cleaner and water. Simple Green®, Formula 409® or equivalent works great. Apply cleaner to outside of air filter and allow to soak. Then flush filter clean from the inside out with a garden hose and repeat steps if necessary. Do not apply high pressure water or air to clean filter. Allow filter to air dry and reinstall.