



Installation Instructions

For Part Numbers:

350-199	700-469 Airaid Oiled Media Filter
351-199	701-469 SynthaMax Dry Media Filter - Red
352-199	702-469 SynthaMax Dry Media Filter - Black
353-199	703-469 SynthaMax Dry Media Filter - Blue

2006-10 Dodge Charger 5.7L, 6.1L

2005-08 Dodge Magnum 5.7L, 6.1L

2005-10 Chrysler 300 5.7L, 6.1L

2008-10 Dodge Challenger 5.7L, 6.1L

INTAKE SYSTEMS FOR VEHICLES LISTED ARE 50 STATE LEGAL. SEE CARB STATUS ON EACH PART FOR A SPECIFIC VEHICLE.

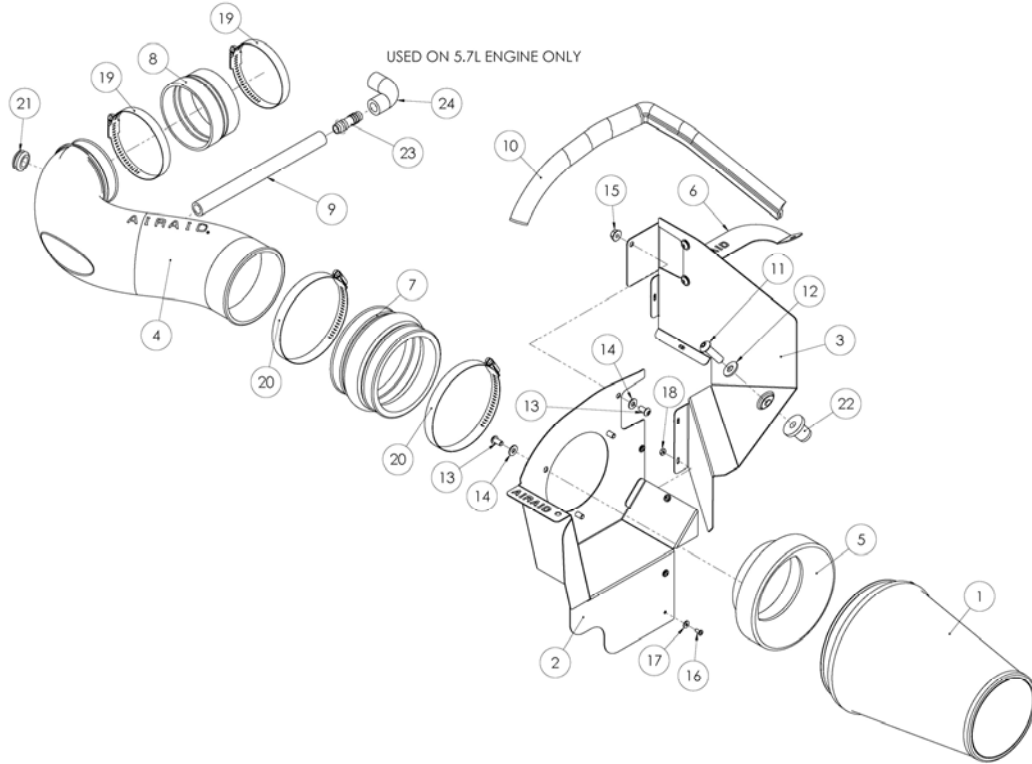

Component Identification

1.	Airaid Premium Filter	1
2.	MAF Panel	1
3.	Back Panel	1
4.	Airaid Intake Tube	1
5.	Filter Adapter	1
6.	Rear Support Bracket	1
7.	Urethane Hump Hose	1
8.	Reducing Coupler	1
9.	Breather Hose	1
10.	Weather Strip 20 1/2"	1
11.	3/8-16 x 1 1/4" Button Head Bolt	1
12.	3/8" Flat Washer	1
13.	1/4 - 20 x 1/2" Button Head Bolt	6
14.	1/4" Flat Washer	6
15.	1/4" Serrated Nut	3
16.	6-32 x 5/16" Screw	5
17.	#6 Flat Washer	5
18.	6-32 Keps Nut	5
19.	#52 Hose Clamp	2
20.	#72 Hose Clamp	2
21.	Grommet	1
22.	Well Nut	1
23.	Male to Male Barbed Fitting	1
24.	90 Deg. Elbow	1
25.	Airaid Decal	1



1. Disconnect the negative battery cable.
If you are working on a 5.7L, first remove the engine beauty cover by lifting it up off of the grommets. Next, loosen the hose clamp that holds the factory intake tube to the throttle body.



2. Disconnect the breather hose from the factory airbox lid.

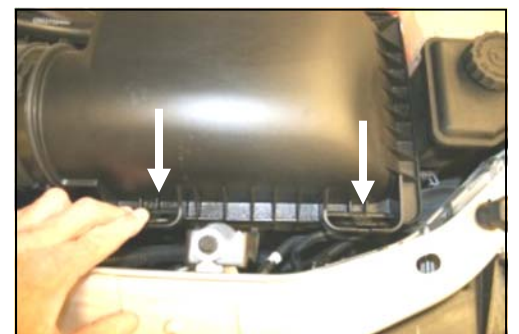

3. Pull both lockdown tabs towards you on the factory airbox lid to remove the lid from the base.



4. Lift the intake tube towards you, and without disconnecting the wiring harness, gently remove the temperature sensor from the factory intake tube, and set it aside.



5. Remove the factory intake hose and lid assembly from the vehicle. Remove the factory air filter.

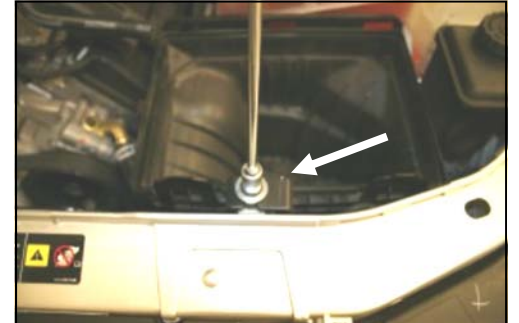

6. With a 10mm socket, remove and save the bolt that holds the factory air filter base to the radiator support. Remove the air filter base from the vehicle.



7. Assemble the two Cool Air Dam (CAD) panels (#2, #3) using five 6-32 x 5/16" screws (#16), #6 flat washers (#17), and 6-32 keps nuts (#18). Apply the Airaid Decal on the Panel as shown.

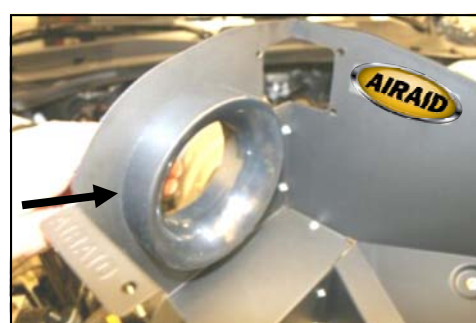

8. Next, install the filter adapter (#5) using three 1/4 - 20 x 1/2" button head bolts (#13), and 1/4 flat washers (#14).



9. Slip the well nut (#22) into the hole in the inner fender.

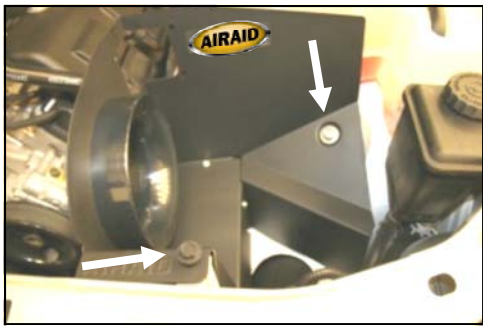

10. Install the CAD into the vehicle. Re-install the factory bolt removed in step #6 thru the CAD and into the radiator support. Next install the 3/8-16 x 1 1/4" button head bolt (#11) and 3/8" flat washer (#12) thru the CAD and into the well nut. Tighten both bolts.

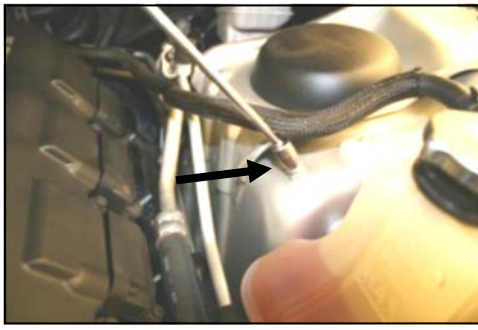

11. Remove the 10mm nut from the stud on the driver's side inner fender and save it for the next step.

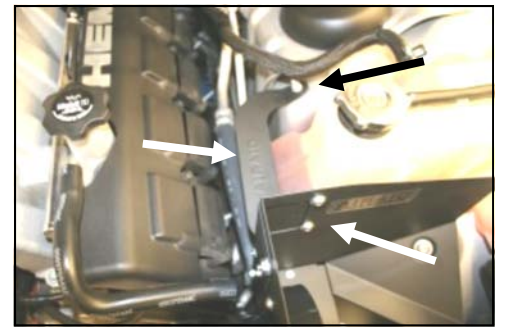

12. Install the rear support bracket (#6) from the CAD to the inner fender using three 1/4 - 20 x 1/2" button head bolts (#13), 1/4" flat washers (#14), 1/4" serrated nuts (#15), and the 10mm factory nut removed in step #11.

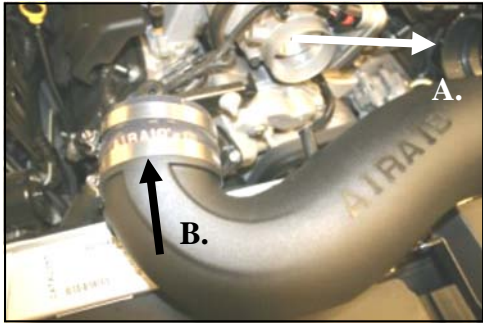

13. **A.** Install the urethane hump hose (#7) onto the filter adapter using two #72 hose clamps (#20), (*Leave loose for now*). **B.** Install the large end of the reducing coupler (#8) on the Airaid Intake Tube (#4), using two #52 hose clamps (#19). Tighten *only* the hose clamp on the tube.

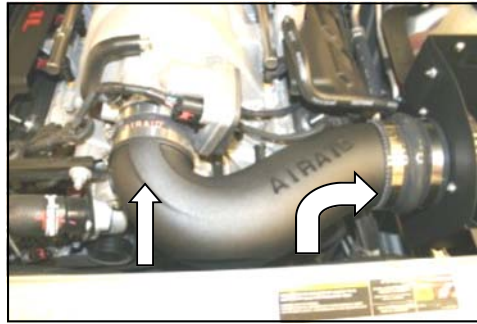

14. Install the Airaid Intake Tube into the hump hose first, and then onto the throttle body, making sure it is flush against the throttle body, adjust for fit, now tighten all of the hose clamps.

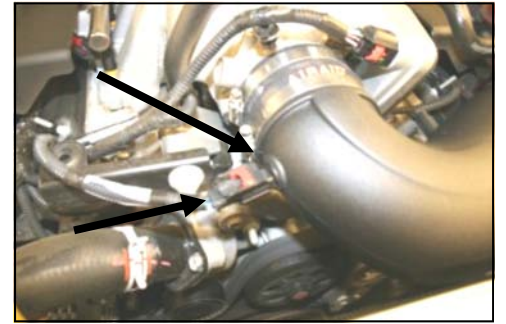

15. Install the grommet (#21) into the hole in the Airaid Intake Tube, and then gently push the temperature sensor (*removed in step #4*) thru the grommet until completely seated.

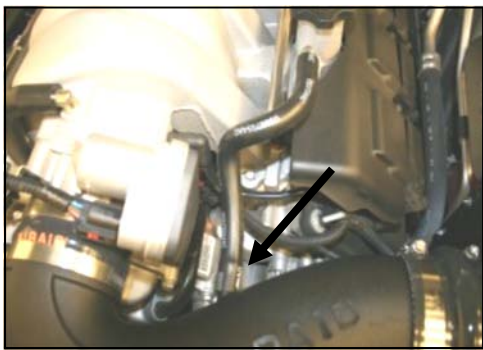

16. If you are working on a 5.7L, skip to step #17. If you are working on a 6.1L, reconnect the factory breather tube to the Airaid Intake Tube as shown.

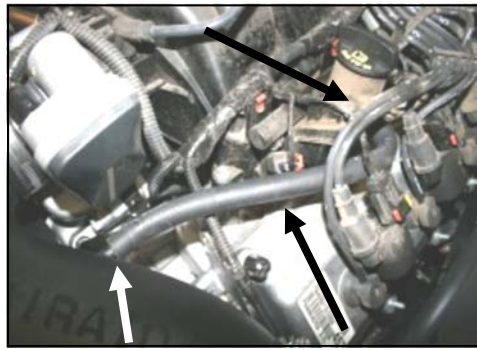

17. If you are working on a 6.1L, skip to step #18. If you are working on a 5.7L, install the Breather Hose, Barbed Fitting and Elbow from the valve cover to the Airaid Intake Tube as shown. (See exploded view for detail) Re-install the engine cover .

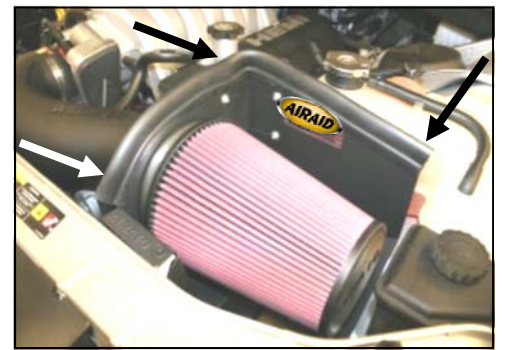

18. Install the Airaid Premium Filter (#1), onto the filter adapter inside of the CAD, and tighten the hose clamp. Next install the weather strip (#10) onto the top of the CAD.

19. Double check your work!

Make sure there is no foreign material in the intake path. Make sure all clamps, hoses, bolts, and

20. Reconnect the negative bat-

Thank you for purchasing the Airaid Intake System. Your Airaid Intake System was carefully inspected and packaged. Check that no parts are missing, or were damaged during shipping. If any parts are missing, contact Airaid. The air filter element is protected from direct exposure to water and debris; care should be taken not to drive through deep water. WATER INGESTION IS THE DRIVERS RESPONSIBILITY! The air filter is reusable and should be cleaned periodically.

FILTER IDENTIFICATION

700-469 Airaid Oiled Media
702-469 Airaid SynthaMax Dry Media - Black

701-469 Airaid SynthaMax Dry Media - Red
703-469 Airaid SynthaMax Dry Media - Blue

For your Oiled media filter we suggest using the AIRAID Filter Tune-Up Kit!



P/N 790-551 Aerosol Spray
P/N 790-550 Squeeze Spray



SynthaMax

Do Not Oil

Synthamax Air Filters do not require oil. Service air filter as needed by cleaning with common non-petroleum all-purpose household cleaner and water. Simple Green®, Formula 409® or equivalent works great. Apply cleaner to outside of air filter and allow to soak. Then flush filter clean from the inside out with a garden hose and repeat steps if necessary. Do not apply high pressure water or air to clean filter. Allow filter to air dry and reinstall.