



INTAKE SYSTEMS FOR VEHICLES LISTED ARE 50 STATE LEGAL.

Installation Instructions

For Part Numbers:

| | |
|---------|--|
| 300-232 | 720-476 Airaid Oiled Media Filter |
| 301-232 | 721-476 SynthaMax Dry Media Filter - Red |
| 302-232 | 722-476 SynthaMax Dry Media Filter - Black |
| 303-232 | 723-476 SynthaMax Dry Media Filter - Blue |

**2002-12 Dodge Ram 1500
4.7L V8**

Component Identification

| | | |
|-----|-------------------------------|---|
| 1. | Airaid Premium Filter | 1 |
| 2. | Airaid Intake Tube | 1 |
| 3. | Cool Air Box | 1 |
| 4. | Urethane Hump Hose | 1 |
| 5. | Silicone Coupler | 1 |
| 6. | Filter Adapter | 1 |
| 7. | Weather Strip 33" | 1 |
| 8. | 1/4-20 X 5/8" Hex Bolt | 3 |
| 9. | 1/4" Flat Washer | 3 |
| 10. | #48 Hose Clamp | 2 |
| 11. | #60 Hose Clamp | 2 |
| 12. | Grommet Plug | 1 |
| 13. | Grommet | 1 |
| 14. | Rubber Cap | 1 |
| 15. | 1/2" x 90° Rubber Elbow | 1 |
| 16. | #14 Speed Clamp | 1 |
| 17. | #16 Speed Clamp | 3 |
| 18. | 1/4"NPT x 1/2" Barbed Fitting | 1 |
| 19. | 1/4"NPT Hex Plug | 1 |
| 20. | 1/2" X 3/4" Barbed Connector | 1 |
| 21. | 1/2" x 4 1/2" Breather Hose | 1 |
| 22. | 1/2" x 1/2" Plastic Elbow | 1 |
| 23. | Adapter Gasket | 1 |

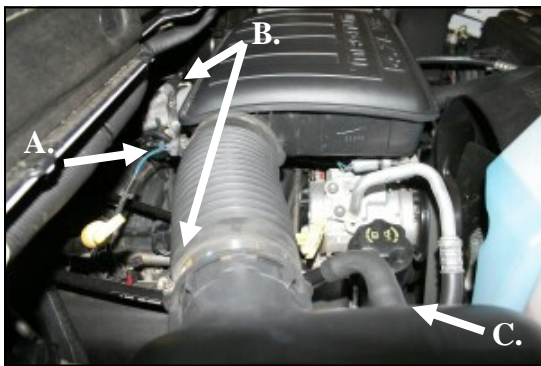
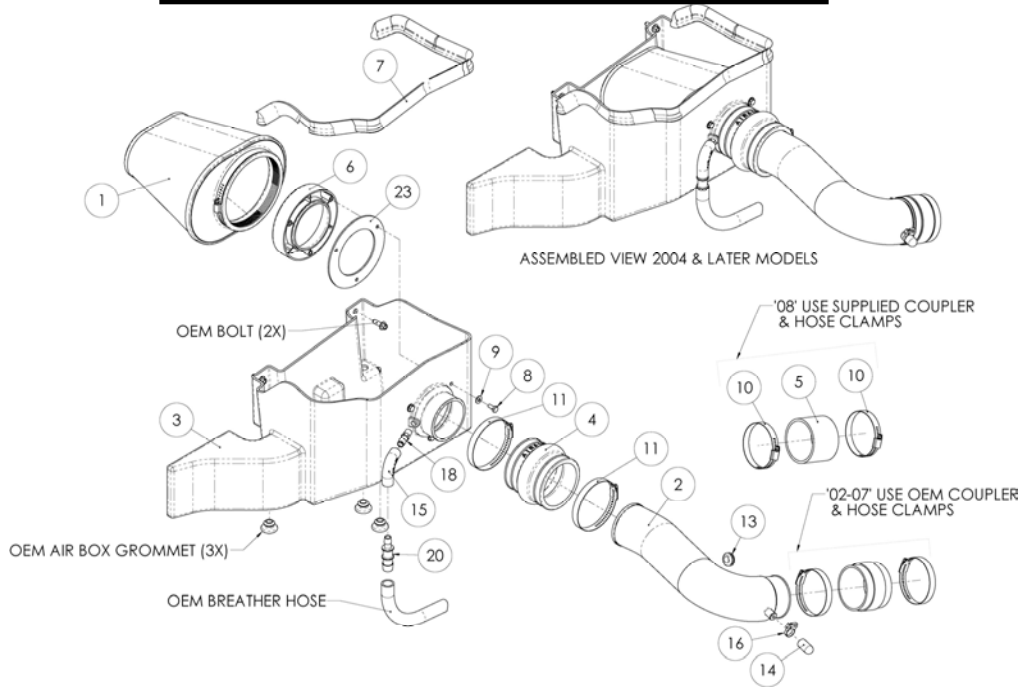

1. Disconnect the negative battery cable.
2003-12 Models: A) Squeeze the tab on the intake air temperature sensor wiring connector on the front or back of the factory resonator, and disconnect it from the sensor. **02-07 Models:** B) Loosen two hose clamps. One on the back of the coupler on the throttle body, and one on the air filter lid side of the flexible intake tube. **2008 Models:** Loosen the hose clamp that holds the flexible tube to the airbox lid. **2004-12 Models:** C) Disconnect the crankcase breather hose from the air filter lid. **2002 & 2003 Models:** Disconnect the breather hose from the back of the resonator.



2. Slide the flexible intake tube off of the airbox lid and then lift the complete airbox straight up and out of the vehicle.



3. Turn the factory air box over and remove 3 of the 4 grommets. They will be reinstalled in the Airaid Cool Air Box in step #8.

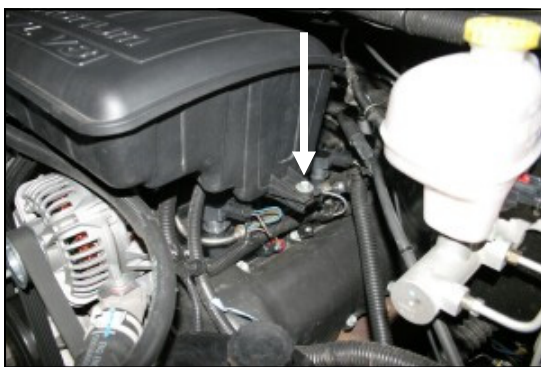

4. Using a 10mm socket, remove the two bolts (one bolt on 2008 and newer models) that secure the intake resonator to the engine, one on the drivers side, and one on the passenger side of the resonator. Grab the resonator with both hands at the front and push back and up to release it from the locator grommet on the bottom. Remove the resonator from the vehicle.



5. 2002-07 Models Loosen the factory hose clamp on the coupler and remove the coupler assembly from the resonator. **2003-12 Models** Rotate the air temp sensor counterclockwise and remove it from the resonator. These parts will be reinstalled on the Airaid intake tube in step #12.

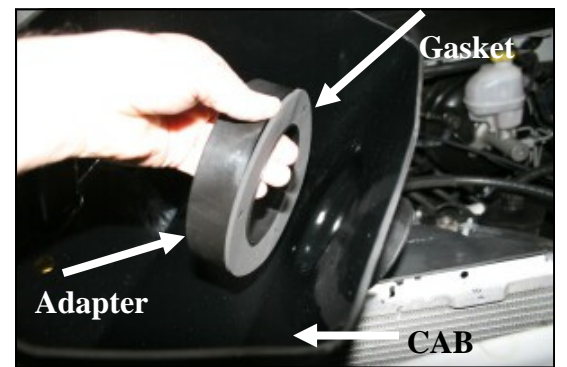

6. Install the filter gasket (#23) and filter adapter (#6) onto the Airaid Cool Air Box, or CAB (#3) as shown using three 1/4" x 5/8" bolts (#8), and 1/4" flat washers (#9). Refer to the line drawing above for reference.

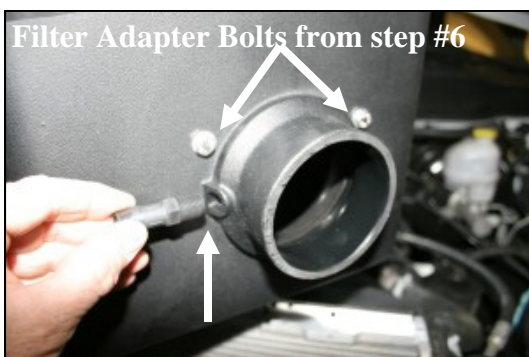

7. 2004-12 Models: Install the 1/4" NPT x 1/2" Barbed fitting (#18) into the CAB as shown. **2002-03 Models** Install the 1/4" hex plug (#19) in place of the barbed fitting.

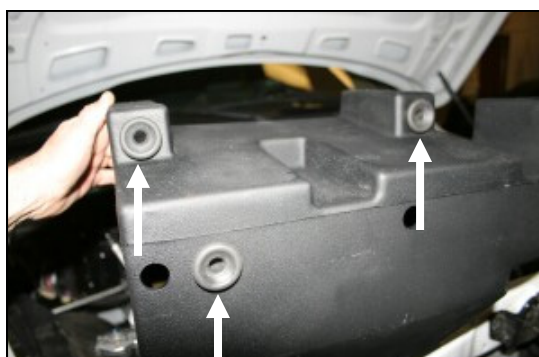

8. Install the factory grommets removed in step #3 into the bottom of the CAB at the locations shown here.



9. Remove the two bolts that secure the factory airbox mounting bracket to the inner fender. They will be reinstalled in step #10.

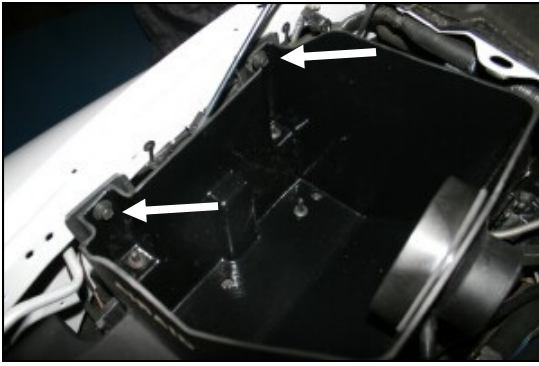

10. Install the CAB into the vehicle aligning the grommets over the locating pins. Reinstall the two factory bolts into the fender that were removed in step #9.

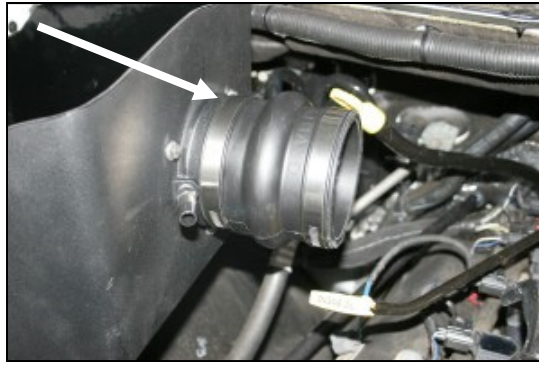

11. Install the hump hose (#4) onto the CAB using two #60 hose clamps (#11). Tighten the hose clamp on the CAB.

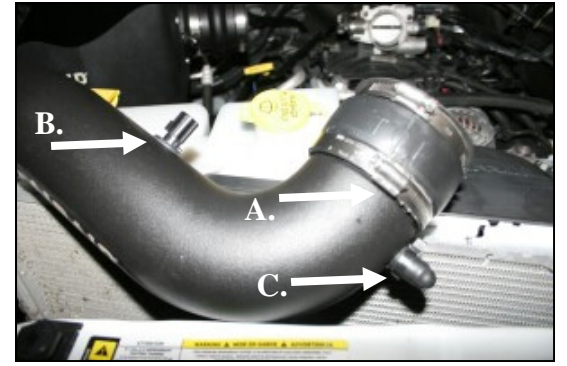

12. 2002-07 Models: A.) Reinstall the factory coupler and hose clamps on to the Airaid intake tube (#2). (2008-12 Models: use the supplied coupler (#5), and #48 hose clamps (#10). Tighten the hose clamp on the tube. 2003-12 Models: B.) Install the supplied grommet (#13) into the hole in the Airaid tube, and then carefully push the factory air temperature sensor into the grommet. 2002 Models: Install the grommet plug (#12) in place of the grommet. 2004-12 Models: C.) Slide the rubber cap (#14) over the nipple on the Airaid intake tube and secure it with the #14 speed clamp (#16).



13. Slide the Airaid intake tube into the hump hose first, and then onto the throttle body. Adjust for fit, and then tighten the two remaining hose clamps. 2003-12 Models: Reconnect the temperature sensor wiring harness to the sensor in the tube. (It may be necessary to remove the tape on the wiring harness, pull out enough wire to reach the temperature sensor, and then retape the harness).

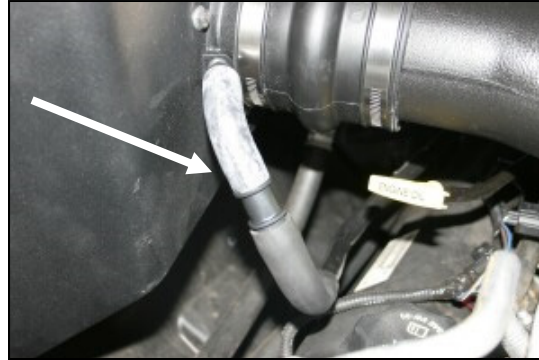

14. 2004-12 Models: Reconnect the factory breather hose to the 1/2" barbed fitting on the CAB using the 1/2" rubber elbow (#15), and 1/2"x 3/4" barbed fitting (#20) as shown.



15. 2002-03 Models: Install one end of the provided 90° barbed fitting (#22) into the factory breather hose and then connect the supplied 1/2" breather hose (#21) to the other end. Connect the hose to the nipple on the Airaid intake tube. Secure all three connections with the provided #16 Speed Clamps (#17).

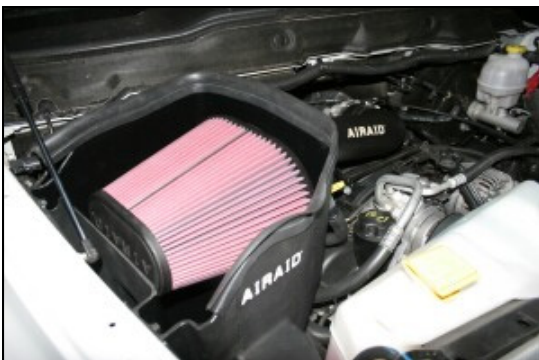

16. Install the Airaid Premium Filter (#1) onto the Airaid filter adapter, and tighten the hose clamp. Install the weather strip (#7) onto the top of the CAB, starting at the fender, and working your way towards the radiator.

17. Double check your work!

Make sure there is no foreign material in the intake path. Make sure all clamps, hoses, bolts, and screws are tight. Periodically check the tightness of all hose clamps.

18. Reconnect the negative battery cable!

Thank you for purchasing the Airaid Intake System. Your Airaid Intake System was carefully inspected and packaged. Check that no parts are missing, or were damaged during shipping. If any parts are missing, contact Airaid. The air filter element is protected from direct exposure to water and debris; care should be taken not to drive through deep water. WATER INGESTION IS THE DRIVERS RESPONSIBILITY! The air filter is reusable and should be cleaned periodically.

FILTER IDENTIFICATION

720-476 Airaid Oiled Media
722-476 Airaid SynthaMax Dry Media - Black

721-476 Airaid SynthaMax Dry Media - Red
723-476 Airaid SynthaMax Dry Media - Blue

For your Oiled media filter we suggest using the AIRAID Filter Tune-Up Kit!



P/N 790-551 Aerosol Spray
P/N 790-550 Squeeze Spray



SynthaMax

Do Not Oil

Synthamax Air Filters do not require oil. Service air filter as needed by cleaning with common non-petroleum all-purpose household cleaner and water. Simple Green®, Formula 409® or equivalent works great. Apply cleaner to outside of air filter and allow to soak. Then flush filter clean from the inside out with a garden hose and repeat steps if necessary. Do not apply high pressure water or air to clean filter. Allow filter to air dry and reinstall.