



Installation Instructions

For Part Numbers:

- 300-277 720-476 Airaid Oiled Media Filter
- 301-277 721-476 SynthaMax Dry Media Filter - Red
- 302-277 722-476 SynthaMax Dry Media Filter - Black
- 303-277 723-476 SynthaMax Dry Media Filter - Blue

2013-17 Dodge Ram 1500/2500/3500
5.7L V8

NOT LEGAL FOR SALE OR USE ON ANY POLLUTION CONTROLLED MOTOR VEHICLE IN CALIFORNIA OR STATES ADOPTING CALIFORNIA EMISSION PROCEDURES.

Component Identification

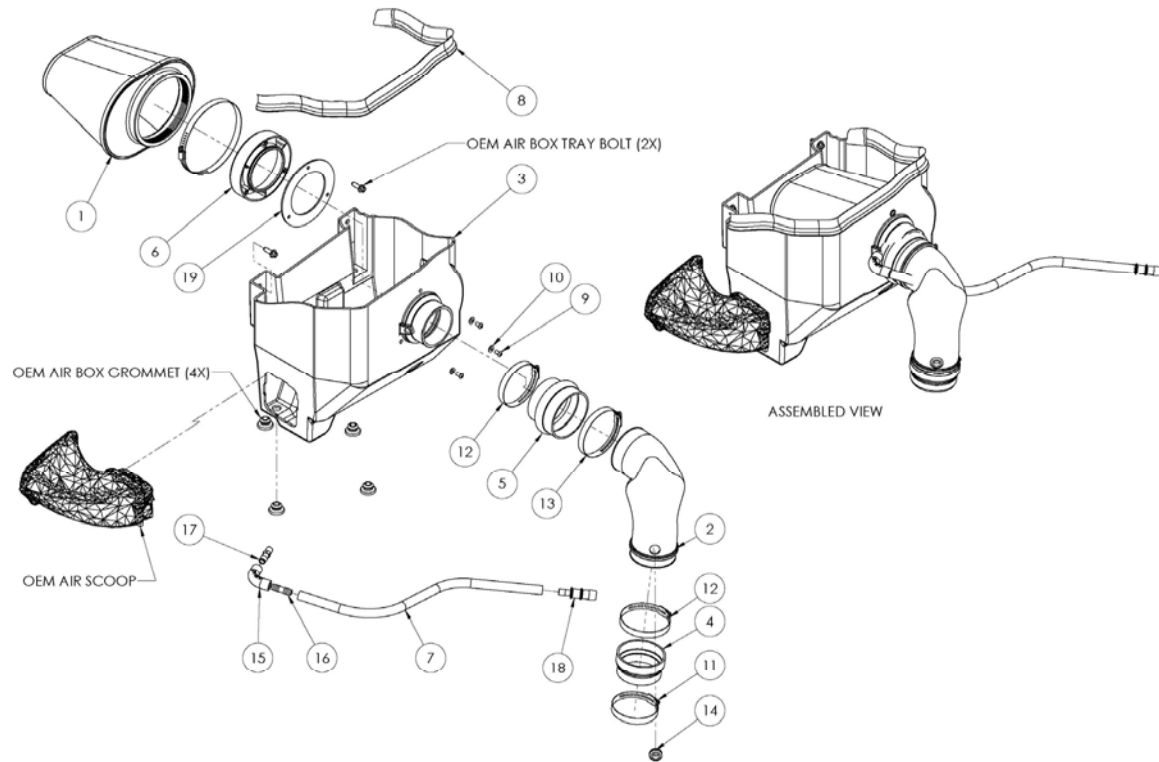

1.AIR-720/721/722/723-476 Airaid Filter	1
2.AIR-KIT237T Airaid Intake Tube	1
3.AIR-KIT277CAB Cool Air Box	1
4.AIR-KITRDCR14 Reducer Coupler	1
5.AIR-KITHUMPHS24 Silicone Hump Hose	1
6.AIR-KIT214FADA Filter Adapter	1
7.AIR-KITHOSE42 1/2" x 22" Breather Hose	1
8.AIR-KITSTRIP24 Weather Strip 32.5"	1
9.AIR-KIT15DHC3050 1/4-20 x 1/2" Button Head Screw	3
10.AIR-KIT09FWZ019 1/4" Flat Washer	3
11.08610 #52 Hose Clamp	1
12.08624 #60 Hose Clamp	2
13.AIR-KITHS64 #64 Hose Clamp	1
14.AIR-KITGRMT02 1/2" ID Grommet	1
15.AIR-KITELBOW04 1/2" x Elbow	1
16.08686 Male to Male Barbed Fitting	1
17.080022 1/4" NPT Barb Fitting	1
18.AEM-8-146 1/2" - 3/4" Barbed Fitting	1
19.AIR-KIT214G Adapter Gasket	1
120.AIR-KIT Airaid Decal	1

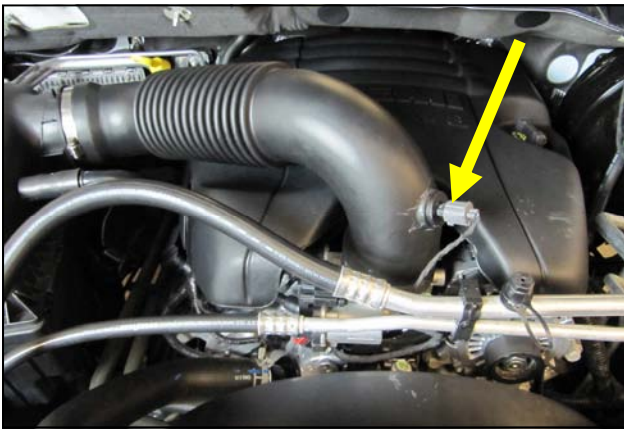

Disconnect The Negative Battery Terminal.
1. Disconnect the air temperature sensor and loosen the clamps on the intake tube. Remove the intake tube and set it aside.

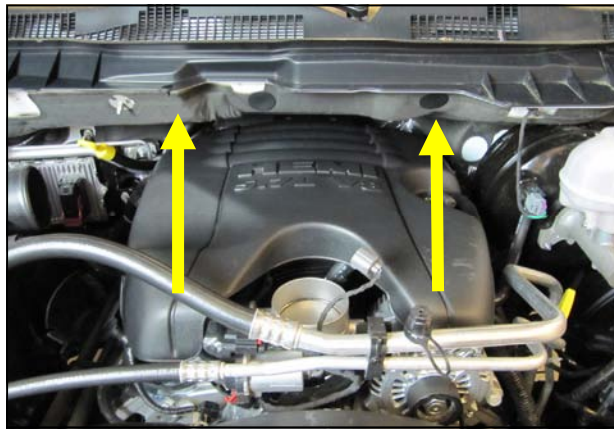

2. Lift the front of the engine cover up to unseat it from the mounting grommets and remove it.

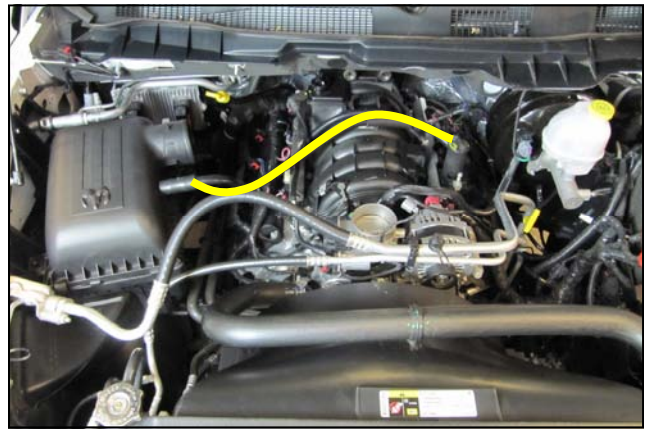

2. Remove the PCV line connecting the air box to the valve cover. Note: The 90 degree fitting on the valve cover is to remain in place.

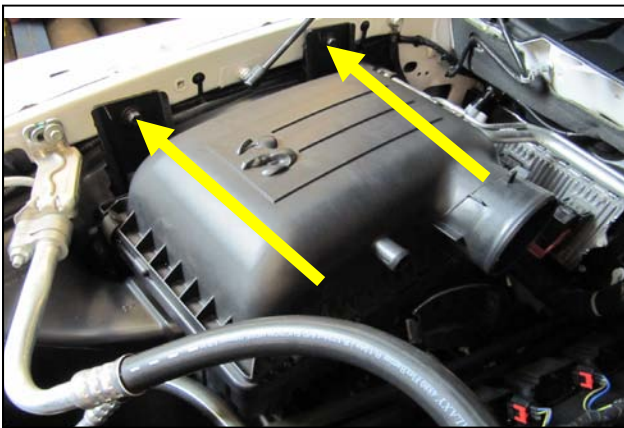

4. Remove the two fender bolts in the air box cradle and remove the entire air box assembly. The bolts will be reused in step 10.

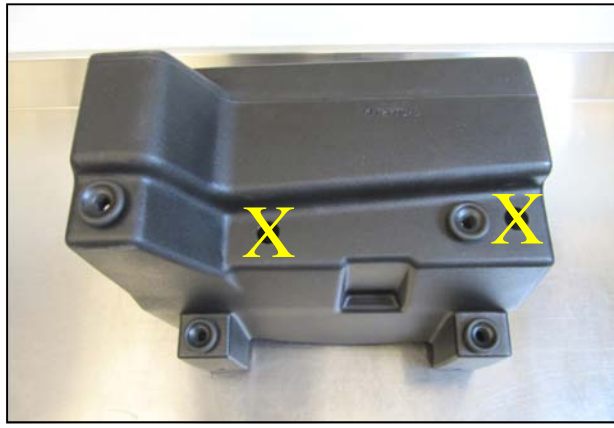

5. Transfer the 4 factory air box grommets into the Airaid Cool Air Box as shown. Note: Two of the holes do not receive grommets.



6. Transfer the air scoop from the factory airbox into the Airaid Cool Air Box as shown.

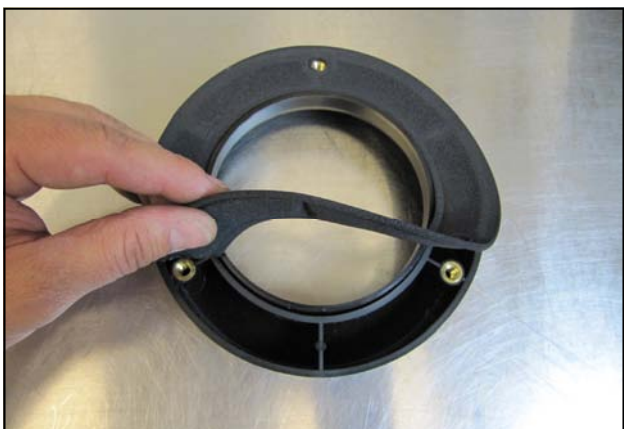

7. Prepare the Filter Adapter for installation by mating it to the Adapter Gasket and aligning the bolt holes.



8. Mount the Filter Adapter and Gasket inside the Cool Air Box as shown using the three sets of 1/4-20 Button Head Screws and 1/4" Flat Washers .

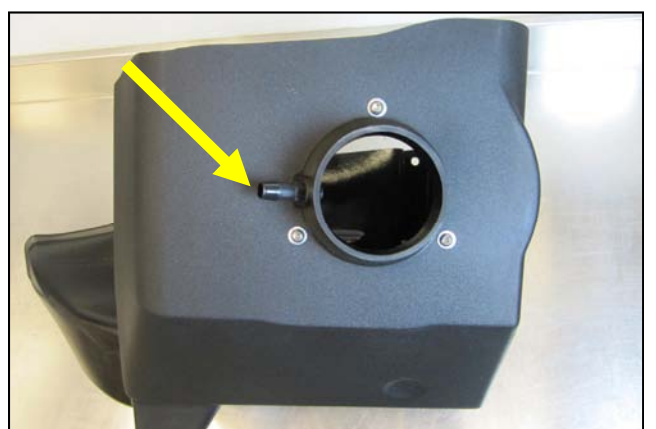

9. Install the 1/4" Barbed Fitting into the Cool Air Box snout as shown.

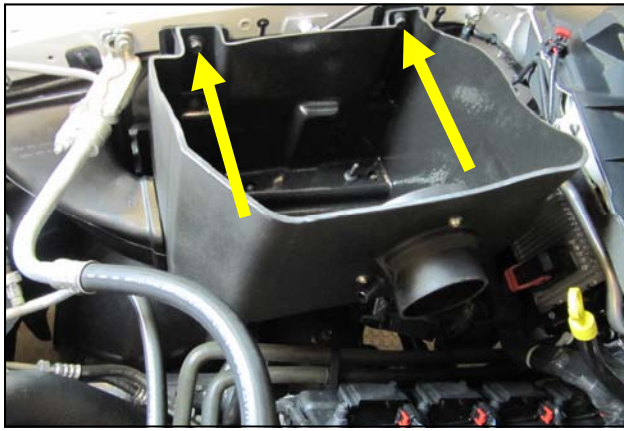

10. Set the Airaid Cool Air Box into the cradle and secure it using the factory hardware removed in step 4.

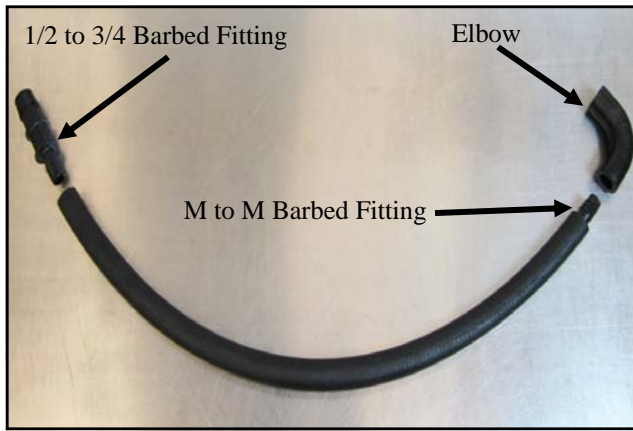

11. Assemble the Airaid PCV line using the 22" Breather Hose, 1/2" to 3/4" Barbed Fitting on one end. On the other end, connect the 1/2" Elbow to the Breather Hose using the Male to Male Barbed Fitting.



12. Install the Elbow side of the Airaid PCV line onto the Barbed Fitting on the Cool Air Box and connect the other side to the factory valve cover elbow.



13. Reinstall the engine cover.



14. Slide the Coupler, Hump Hose and Clamps onto the Airaid Intake Tube as shown. Do not tighten the Clamps at this time. Refer to the line drawing and packing list for

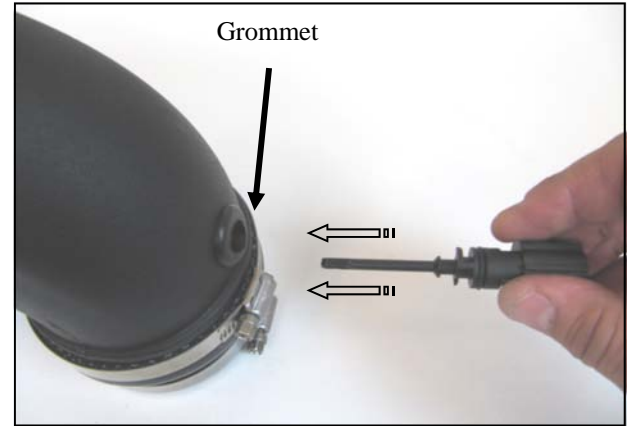

15. Insert the 1/2" Grommet into the Airaid Intake Tube. Transfer the air temperature sensor from the factory intake tube, into the Airaid Tube. Hint: A small amount of silicone or soapy water makes for a safe Grommet/O-ring lubricant.



16. Install the Intake Tube, Hump Hose side first, onto the Cool Air Box, then onto the throttlebody. Align all four Clamps and tighten them. Reconnect the air temperature sensor.



17. Install the Airaid Premium Filter onto the Filter Adapter inside the Cool Air Box. Install the Weatherstrip onto the Cool Air Box as shown, with the contour rolling away from the Filter. Complete the install by applying the Airaid Decal to the inside of the Airbox.

18. Double check your work!

Make sure there is no foreign material in the intake path. Make sure all clamps, hoses, bolts, and screws are tight. Double check the hood clearance!

Reconnect the negative battery cable!

Thank you for purchasing the Airaid Intake System. Your Airaid Intake System was carefully inspected and packaged. Check that no parts are missing, or were damaged during shipping. If any parts are missing, contact Airaid. The air filter element is protected from direct exposure to wa-ter and debris; care should be taken not to drive through deep water. WATER INGESTION IS THE DRIVERS RESPONSIBILITY! The air filter is reusable and should be cleaned periodically.

FILTER IDENTIFICATION

720-476 Airaid Oiled Media
722-476 Airaid SynthaMax Dry Media - Black

721-476 Airaid SynthaMax Dry Media - Red
723-476 Airaid SynthaMax Dry Media - Blue

For your Oiled media filter we suggest using the AIRAID Filter Tune-Up Kit!



Do Not Oil



P/N 790-551 Aerosol Spray
P/N 790-550 Squeeze Spray

Synthamax Air Filters do not require oil. Service air filter as needed by cleaning with common non-petroleum all-purpose household cleaner and water. Simple Green®, Formula 409® or equivalent works great. Apply cleaner to outside of air filter and allow to soak. Then flush filter clean from the inside out with a garden hose and repeat steps if necessary. Do not apply high pressure water or air to clean filter. Allow filter to air dry and reinstall.