



Installation Instructions

For Airaid Jr. Part Numbers:

250-701 850-047 Airaid Oiled Media Filter
 251-701 851-047 SynthaMax Dry Media Filter
 And M.I.T. Part Number
 250-901 Airaid Modular Intake Tube only
**2016-18 Chevrolet Camaro SS
 6.2L V8**

NOT LEGAL FOR SALE OR USE ON ANY POLLUTION CONTROLLED MOTOR VEHICLE IN CALIFORNIA OR STATES ADOPTING CALIFORNIA EMISSION PROCEDURES.

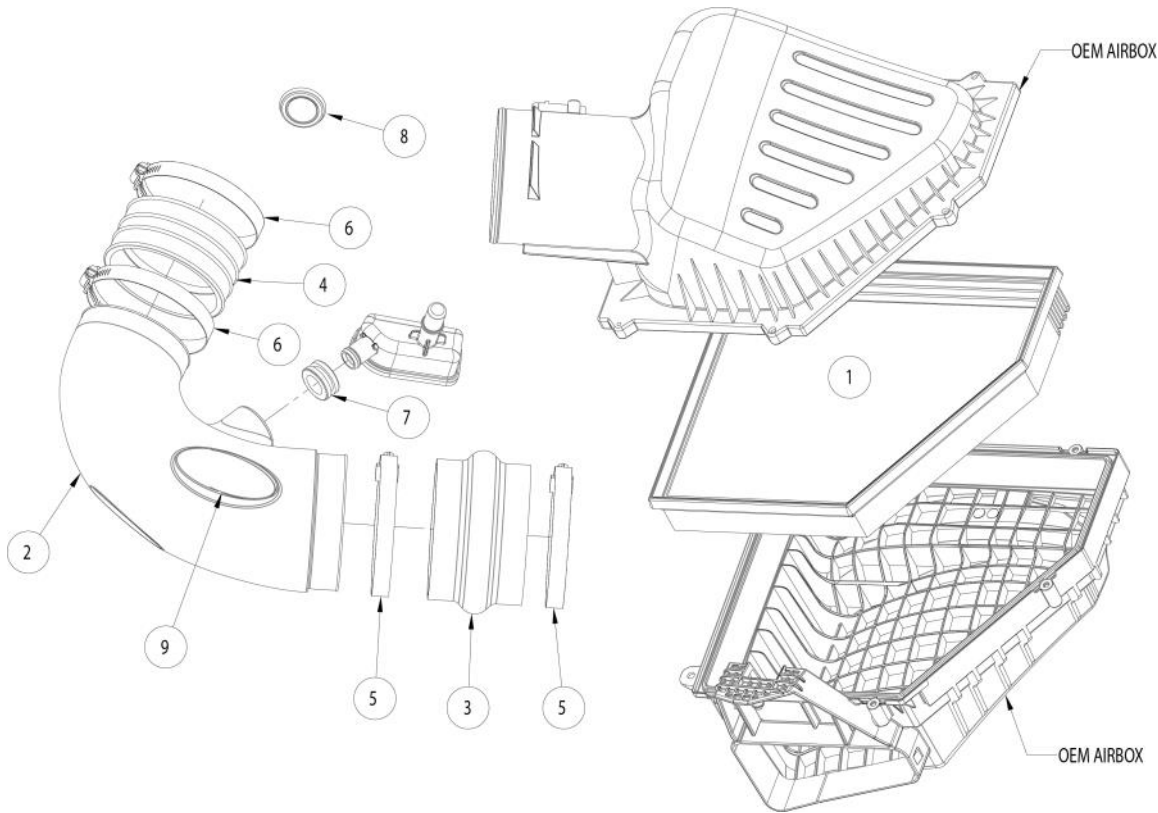

Component Identification

1 850/851-047	Airaid Air filter	1
2 KIT901	Modular Intake Tube	1
3 KITHUMPHS37	Hump Hose	1
4 KITCOUPLER10EPDM	Coupler	1
5 KITHS72	# 72 Clamp	2
6 KITHS64	# 64 Clamp	2
7 KITGRMT19	Grommet	1
8 KITPLUG03	Firewall Plug	1
9 KITSTICKER12	Airaid Decal	1

***Filter included only in Jr. Kits**



1. Inside the trunk, on the passenger side, locate and remove the battery access panel. Disconnect the Negative battery terminal.

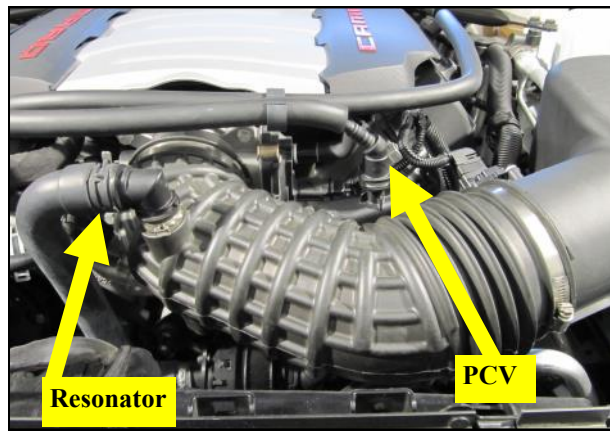

2. Compress the spring clamp on the resonator tube and separate the tube from the 90 deg. fitting in the intake tube. Depress the grey locking tab in the PCV fitting and disconnect the PCV line from the intake.

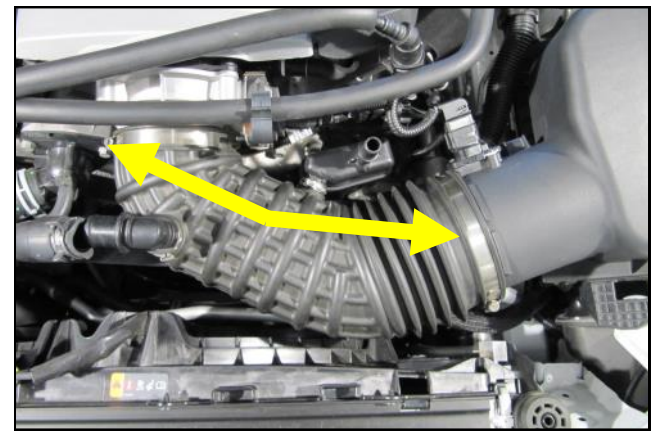

3. Loosen the clamps on both ends of the intake tube and remove it from the vehicle.

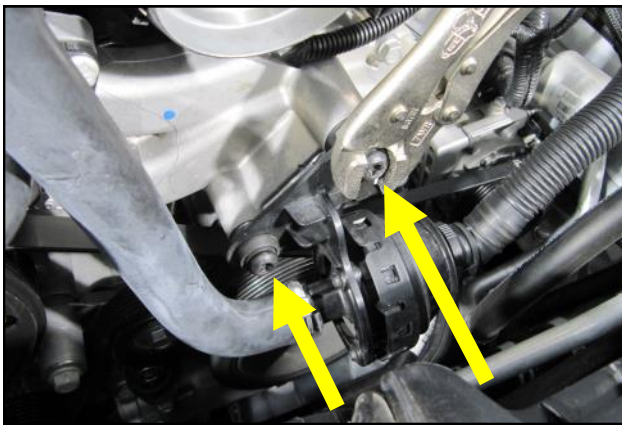

4. Remove the two bolts in the resonator diaphragm bracket using a T-50 Torx bit or with a pair of locking pliers as shown. The resonator, bolts and bracket will not be used with the Airaid.

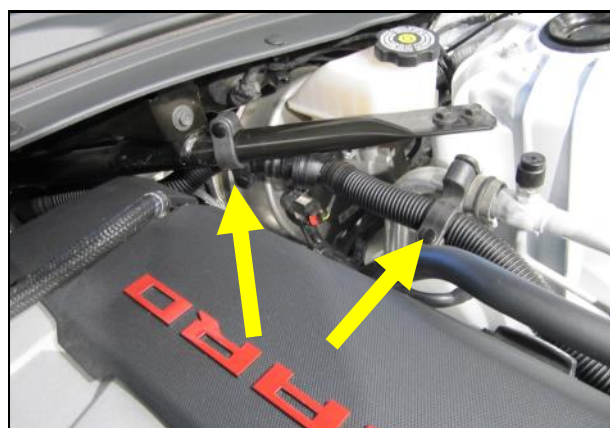

5. Separate the resonator tube from the airbox lid. Follow the tube up to the master cylinder area and disconnect the tube retainers on the strut tower brace and the A/C line.



6. At the firewall, remove the 6mm flange nut at the resonator tube base. Turn the tube 1/4 turn Clockwise and remove the entire resonator from the vehicle. It will not be reused.



7. Insert the Firewall Plug into the resonator tube hole.

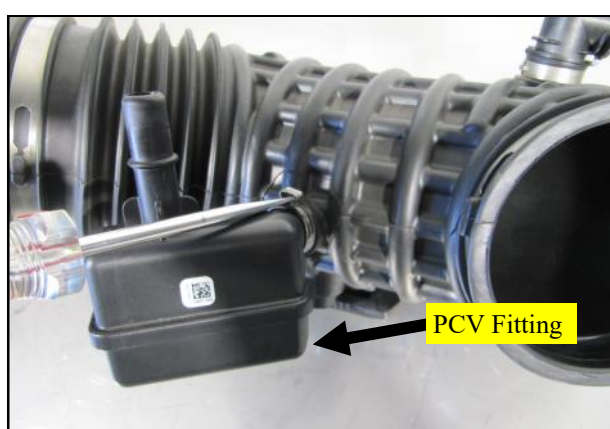

8. Using a small flat tip screwdriver, uncrimp the clamp securing the PCV fitting to the intake tube.

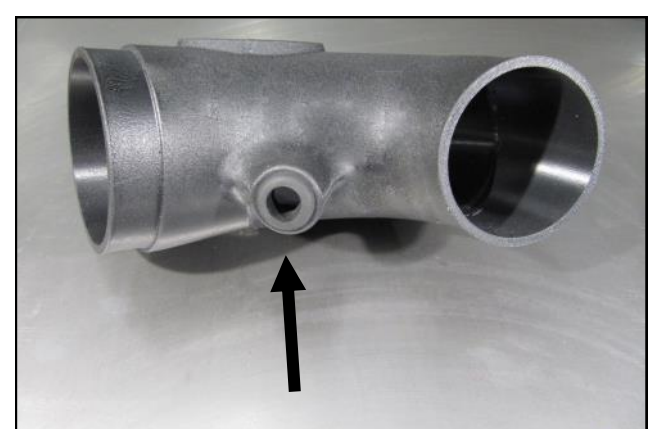

9. Insert the grommet into the Intake Tube as shown.



10. Transfer the PCV fitting into the Intake tube and apply the Airaid Decal as shown.

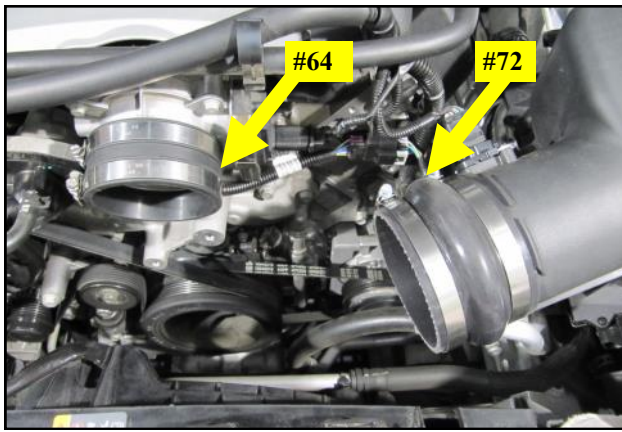

11. Slide the Coupler and the 64 Clamps onto the throttlebody and the Hump Hose with the 72 Clamps onto the airbox outlet.



12. Insert the Intake Tube into the coupler first, then into the Hump Hose. Tighten all four clamps at this time.

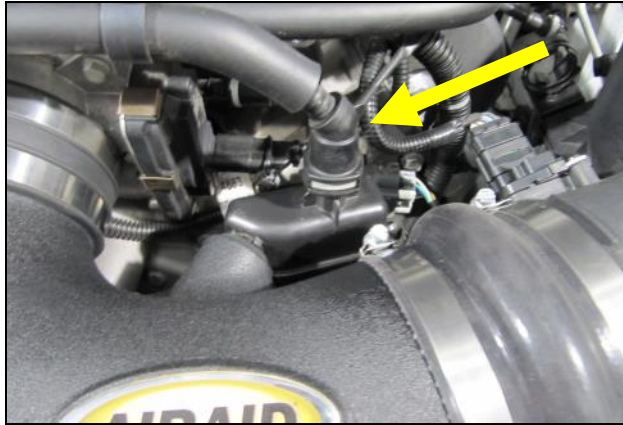

13. Reconnect the PCV line.



14. Slowly lower the hood to test clearances. Make sure all clamps, hoses, bolts, and screws are tight. Double check the hood clearance. Reconnect the negative battery terminal and re install the access panel.

FILTER IDENTIFICATION

850-427 Airaid Oiled Media

851-427 Airaid SynthaMax Dry Media

For your Oiled media filter we suggest using the AIRAID Filter Tune-Up Kit.



P/N 790-551 Aerosol Spray
P/N 790-550 Squeeze Spray

SynthaMax®

Do Not Oil

Synthamax Air Filters do not require oil. Service air filter as needed by cleaning with common non-petroleum all-purpose household cleaner and water. Simple Green®, Formula 409® or equivalent works great. Apply cleaner to outside of air filter and allow to soak. Then flush filter clean from the inside out with a garden hose and repeat steps if necessary. Do not apply high pressure water or air to clean filter. Allow filter to air dry and reinstall.



NOT LEGAL FOR SALE OR USE ON ANY POLLUTION CONTROLLED MOTOR VEHICLE IN CALIFORNIA OR STATES ADOPTING CALIFORNIA EMISSION PROCEDURES.