



Installation Instructions

For Airaid Jr. Part Numbers:

250-714 850-427 Airaid Oiled Media Filter

251-714 851-427 SynthaMax Dry Media Filter

And M.I.T. Part Number

250-914 Airaid Modular Intake Tube only

2010-15 Chevrolet Camaro SS

6.2L V8

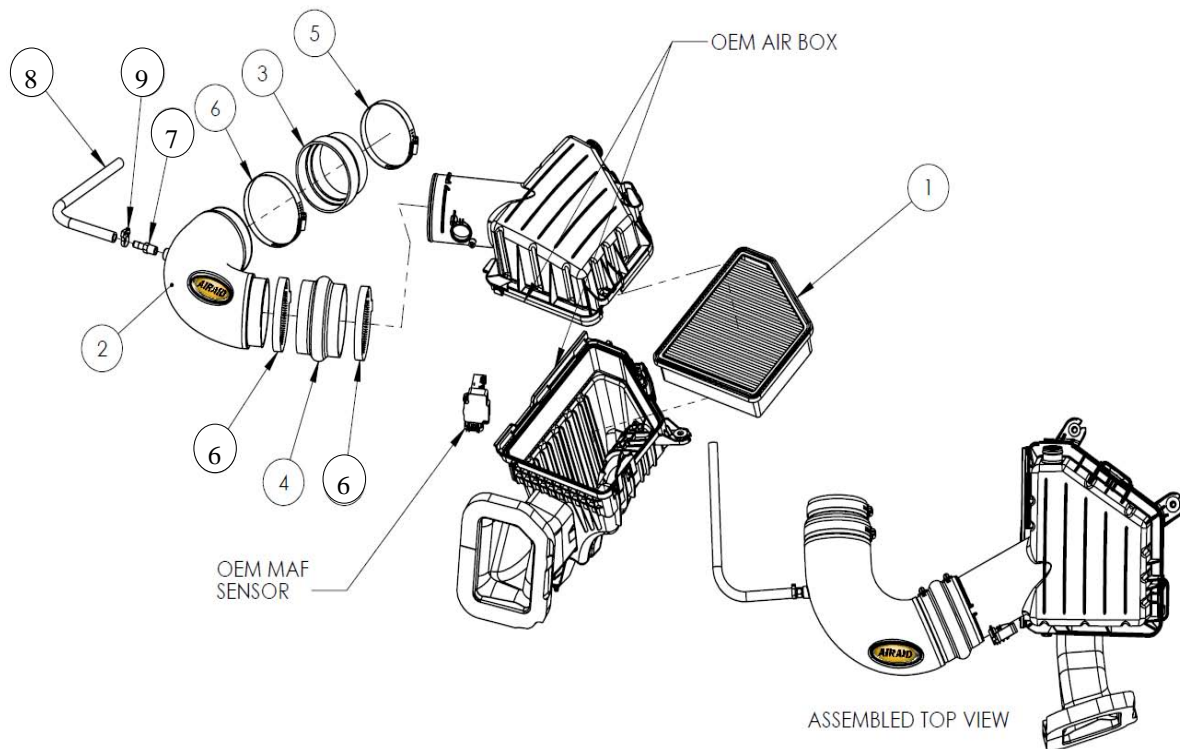

Component Identification

1.	850/851-427	*Airaid Premium Filter	1
2.	AIR-KIT714	Modular Intake Tube	1
3.	KITRDCR16	Reducing Coupler	1
4.	AIR-KITHUMPHS05EPDM	Hump Hose	1
5.	08624	#60 Hose Clamp	1
6.	AIRKITHS68	#68 Hose Clamp	3
7.	08047	1/4\"NPT 3/8\" Hose Fitting	1
8.	AIR-KITHOSE26	3/8\"x18\" Breather Hose	1
9.	KITSNP14M4	5/8\" Speed Clamp	1
10.	KITSTICKER12	Airaid Decal	1

*Filter included only in Jr. Kits



1. Disconnect the negative battery terminal. Remove the oil cap and lift up on the engine cover to unseat it from the mounting grommets. Replace the oil cap for now to prevent debris from entering the valve cover.



2. Disconnect the crankcase breather on the factory intake tube. It simply "Snaps" into place and can be removed with a firm tug.

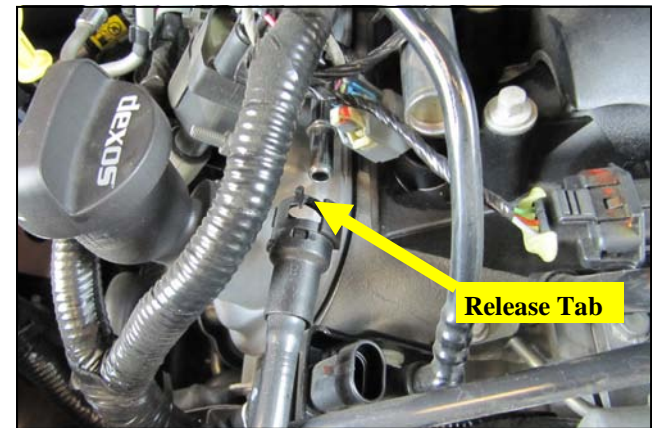

3. Locate the locking ring and its release tab inside of the crankcase breather fitting above the passenger side valve cover and release it from the steel line. Remove the breather from the vehicle. It will not be reused.

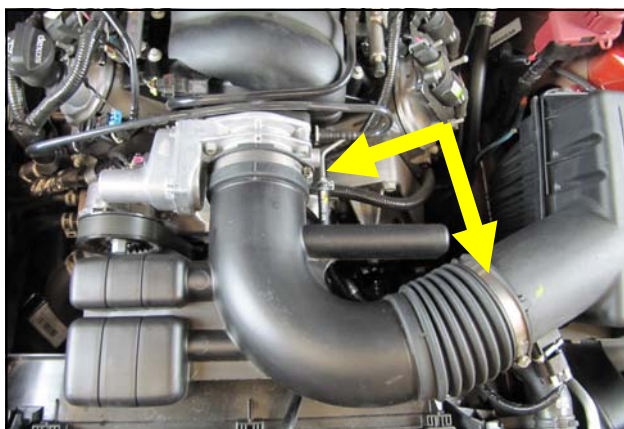

4. Loosen the clamps on the throttle body and the air box and remove the intake tube from the vehicle



5. If installing an Airaid JR kit, install the Airaid Premium filter into the factory air box at this time.

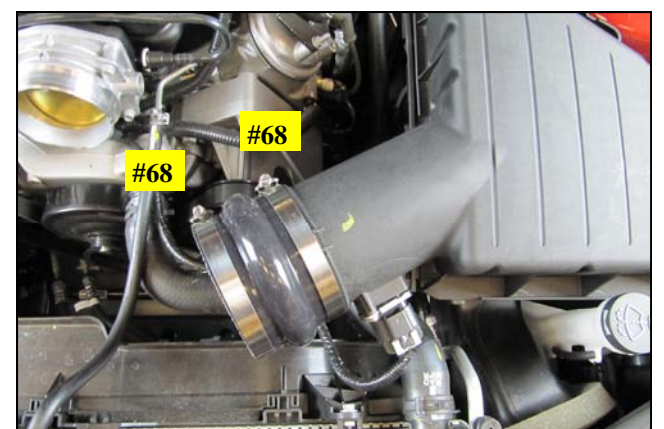

6. Install the Hump Hose and the #68 Clamps onto the throttle body as shown. Do not tighten the Clamps at this time.

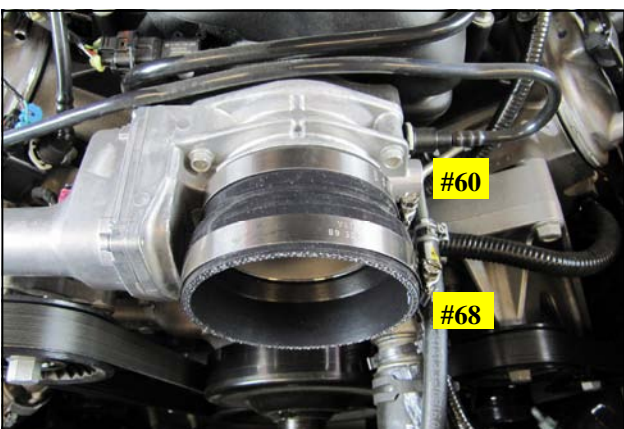

7. Install the Coupler and Clamps onto the throttle body as shown. Do not tighten the Clamps at this time.



8. Install the Barbed Fitting into the Airaid Intake Tube. Apply the Airaid Bubble Decal onto the Intake Tube as shown.



9. Insert the Intake Tube assembly into the Hump Hose first then into the Coupler on the throttle body. Align the components and tighten the Clamps.

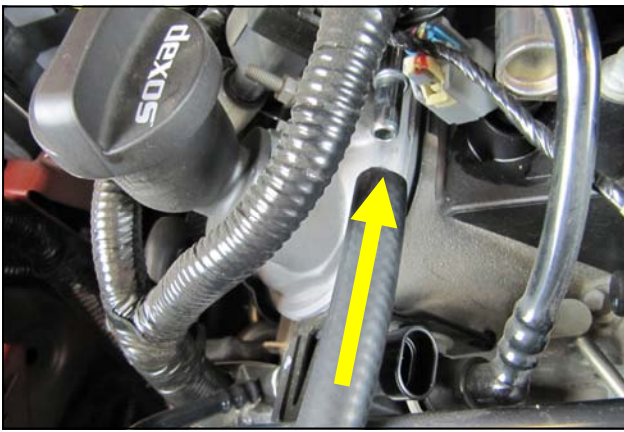

10. Slide the 3/8" Breather Hose onto the steel crankcase breather tube on the valve cover. Refer to step #3.

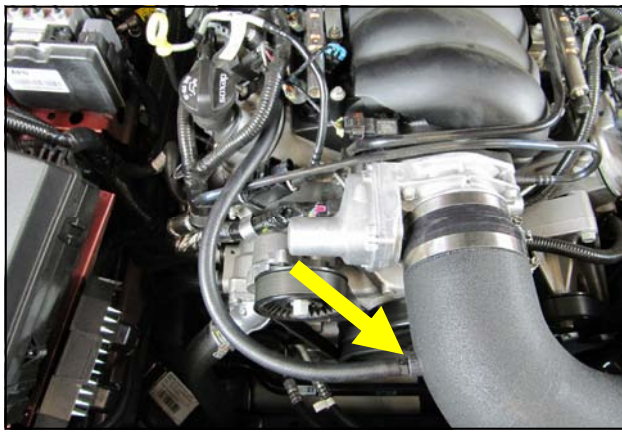

11. Secure the Breather Hose to the Barbed Fitting using the plastic Speed Clamp.



12. Reinstall the engine cover and oil cap. Reconnect the battery terminal.

Thank you for purchasing the Airaid Intake System. Your Airaid Intake System was carefully inspected and packaged. Check that no parts are missing, or were damaged during shipping. If any parts are missing, contact Airaid. The air filter element is protected from direct exposure to water and debris; care should be taken not to drive through deep water. **WATER INGESTION IS THE DRIVERS RESPONSIBILITY!** The air filter is reusable and should be cleaned periodically.

FILTER IDENTIFICATION

850-427 Airaid Oiled Media

851-427 Airaid SynthaMax Dry Media

For your Oiled media filter we suggest using the AIRAID Filter Tune-Up Kit!

SynthaMax[®]

Do Not Oil

Synthamax Air Filters do not require oil. Service air filter as needed by cleaning with common non-petroleum all-purpose household cleaner and water. Simple Green[®], Formula 409[®] or equivalent works great. Apply cleaner to outside of air filter and allow to soak. Then flush filter clean from the inside out with a garden hose and repeat steps if necessary. Do not apply high pressure water or air to clean filter. Allow filter to air dry and reinstall.



P/N 790-551 Aerosol Spray
P/N 790-550 Squeeze Spray

