



Installation Instructions

For Part Numbers:

- 200-295 720-472 Airaid Oiled Media Filter
- 201-295 721-472 SynthaMax Dry Media Filter - Red
- 202-295 722-472 SynthaMax Dry Media Filter - Black
- 203-295 723-472 SynthaMax Dry Media Filter - Blue

2013-2016 Chevrolet Silverado 2500/3500
2013-2016 GMC Sierra 2500/3500
6.6L Duramax LML

INTAKE SYSTEMS FOR VEHICLES LISTED ARE 50 STATE LEGAL. SEE CARB STATUS ON EACH PART FOR A SPECIFIC VEHICLE.

Component Identification

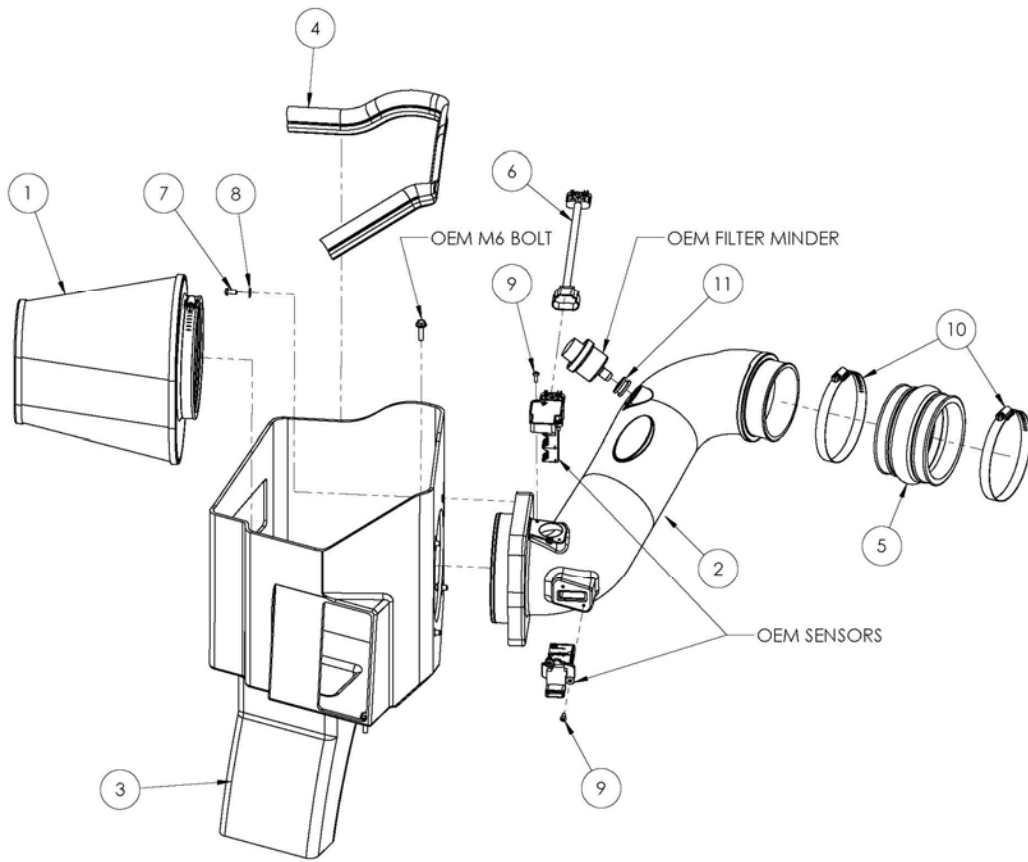

1. AIR-720,721,722,723-472	Airaid Premium Filter	1
2. AIR-KIT295-1	Intake Tube	1
3. AIR-KIT219CAB	Cold Air Box	1
4. AIR-KITSTRIP20	Weatherstrip	1
5. AIR-KITHUMPHOSE05EPDM	Hump Hose	1
6. AIR-KIT295EXT	Extension Harness	1
7. AIR-KITDHC3050	1/4-20 Button Head Screw	4
8. AIR-KIT09FWZ019	1/4" Flat Washer	4
9. AIR-KITBHC3050	#8-32 Button Head Screw	4
10. AIR-KITHS72	#72 Hose Clamp	2
11. AIR-KITGRMT03	1/2" Grommet	1
12. AIR-KITGRMT17-1	Blind Grommet	1
13. AIR-KITBIT01	T-20 Torx Bit	1
14. AIR-KITSTICKER12	Airaid Bubble Decal	1

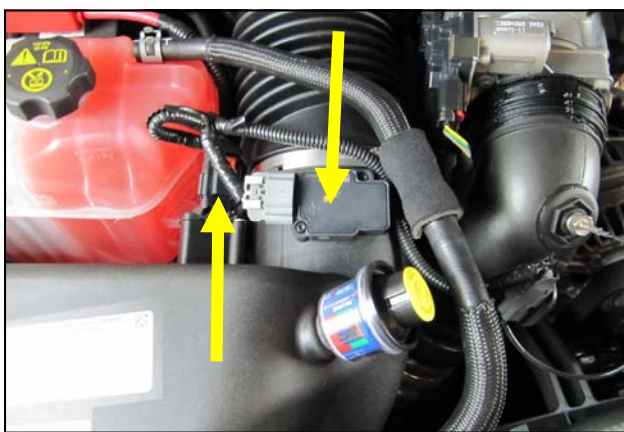

Disconnect The Negative Battery Terminal.
1. Disconnect both of the Mass Air Flow sensors.

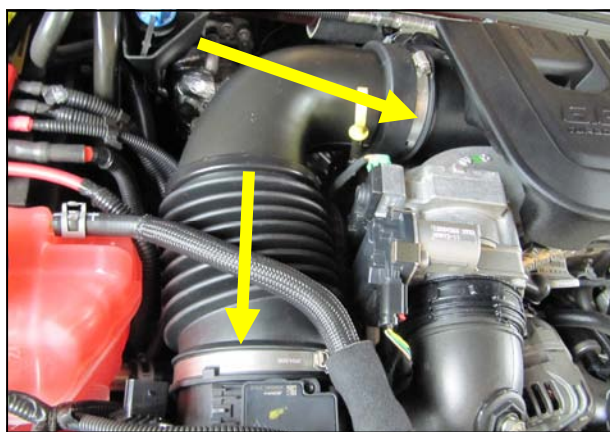

2. Loosen the clamps on both ends of the factory intake tube and remove the tube from the vehicle.

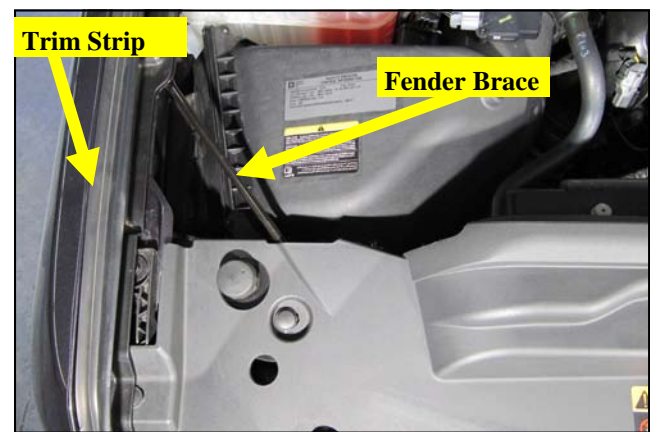

3. If equipped, remove the inner fender trim strip and the front fender brace. Rotate the airbox assembly away from the fender to unseat it from the mounting grommets and remove the entire assembly from the vehicle.

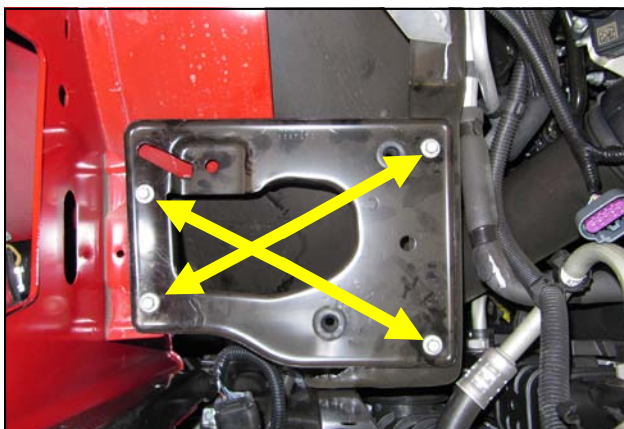

4. Remove the four bolts in the airbox mounting tray and remove the tray from the vehicle. Three of the four bolts will be reused in step 14.

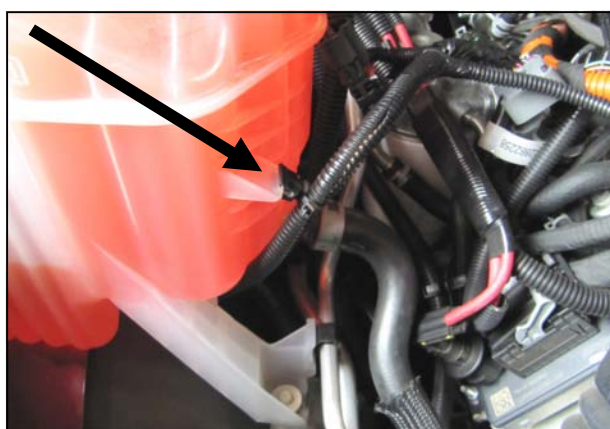

5. Unclip the wire harness from the coolant bottle to gain additional length.



6. Transfer the Mass Air Flow sensors into the Airaid intake Tube and secure them using two 8-32 x 1/2" Button Head Screws. Do Not Use Factory Screws!

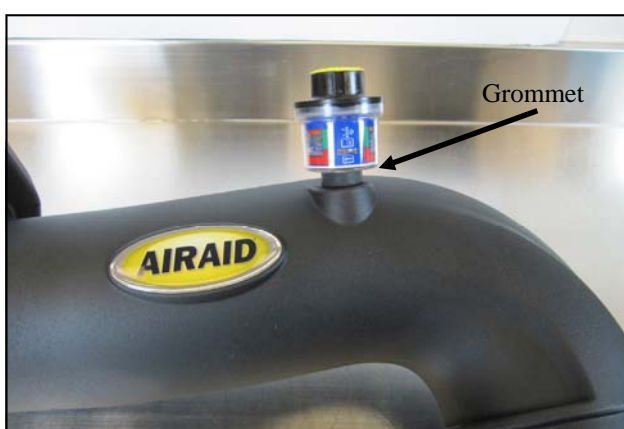

7. Install the 1/2" Grommet into the Airaid Intake Tube and transfer the OEM filter minder into it. Do not use the factory Grommet.

If your vehicle is not equipped with a filter minder, insert the Blind Grommet into the Intake tube. Apply the Airaid Bubble Decal onto the Intake Tube as shown.



8. Slide the Hump Hose and Clamps onto the turbo inlet. Leave the clamps loose for now.



9. Slide the Airaid Intake Tube under the coolant hose and up the against the cowl as shown.

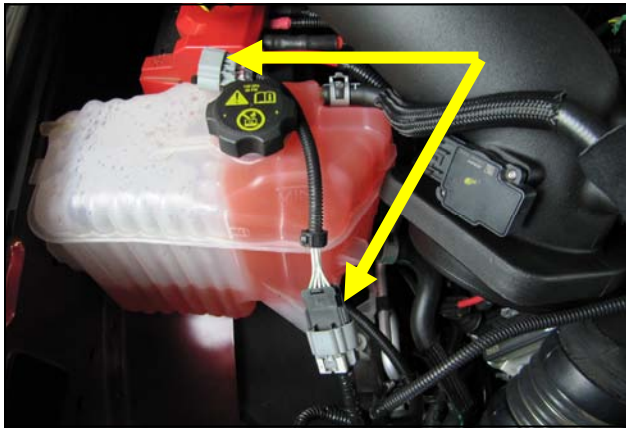

10. Extend the Primary Mass Air Flow sensor's wire harness.



11. Set the Airaid Cold Air Box in the inner fender area as shown.



12. Slide the Intake Tube down and into the Cold Air Box, then into the Hump Hose on the turbo inlet.

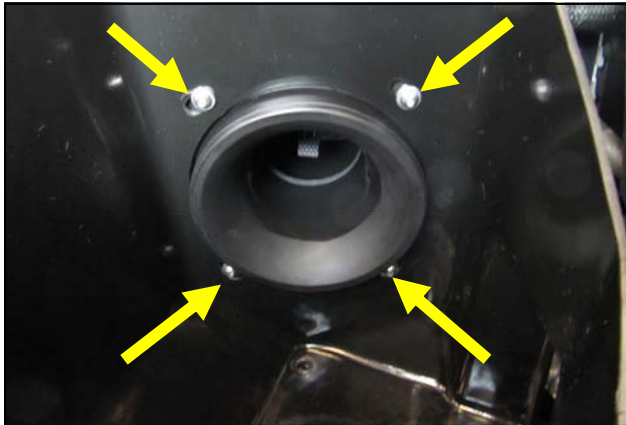

13. Install the four 1/4" Button Head Screws, and four Flat Washers into the Airaid Intake Tube from inside the Cold Air Box.

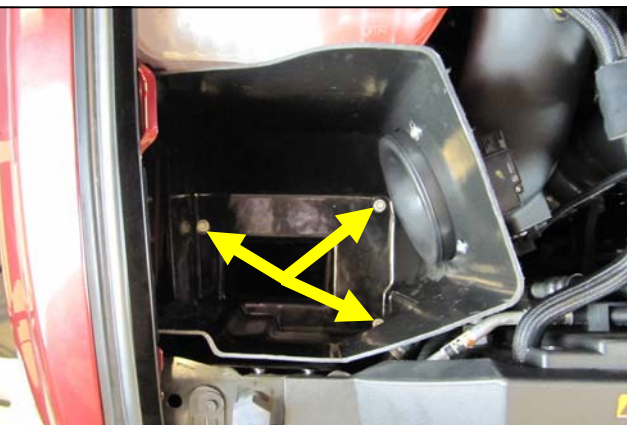

14. Secure the Cold Air Box to the inner fender using three of the OEM bolts removed in step 4.



15. Tighten the two Hump Hose Clamps. On the turbo inlet.



16. Reconnect the Mass Air Flow sensors. Note: the Extension Harness is to be routed underneath the Intake Tube.



17. Install the Airaid Premium Filter onto the Intake Tube inside of the Cold Air Box. Install the Weather Strip onto the top edge of the Cold Air Box with the contour rolling away from the filter. Reinstall the fender trim and brace.



18. **Double check your work!** Make sure there is no foreign material in the intake path. Make sure all clamps, hoses, bolts, and screws are tight. Double check the hood clearance!
Reconnect the negative battery cable!

WARNING! If your vehicle has a Vehicle Emission Control Information decal affixed to the factory airbox, a new replacement label must be obtained and installed in a readily visible position in the engine compartment in order to remain CARB compliant. Failure to do so will prevent the vehicle from passing a smog check. Replacement labels can be ordered from your local dealership. Regulations state that the VECEI label shall not be affixed to any equipment which is easily detached from the vehicle. Label placement, under the hood on a painted surface is recommended.

Thank you for purchasing the Airaid Intake System. Your Airaid Intake System was carefully inspected and packaged. Check that no parts are missing, or were damaged during shipping. If any parts are missing, contact Airaid. The air filter element is protected from direct exposure to water and debris; care should be taken not to drive through deep water. WATER INGESTION IS THE DRIVERS RESPONSIBILITY! The air filter is reusable and should be cleaned periodically.

FILTER IDENTIFICATION

720-472 Airaid Oiled Media
722-472 Airaid SynthaMax Dry Media - Black

721-472 Airaid SynthaMax Dry Media - Red
723-472 Airaid SynthaMax Dry Media - Blue

For your Oiled media filter we suggest using the AIRAID Filter Tune-Up Kit!



P/N 790-551 Aerosol Spray
P/N 790-550 Squeeze Spray



SynthaMax

Do Not Oil

Synthamax Air Filters do not require oil. Service air filter as needed by cleaning with common non-petroleum all-purpose household cleaner and water. Simple Green®, Formula 409® or equivalent works great. Apply cleaner to outside of air filter and allow to soak. Then flush filter clean from the inside out with a garden hose and repeat steps if necessary. Do not apply high pressure water or air to clean filter. Allow filter to air dry and reinstall.