



**Installation Instructions
For Part Numbers:**

300-986 Modular [Intake Tube](#)
300-786 Jr. Kit 850-357 Airaid Oiled Media Filter
301-786 Jr. Kit 851-357 SynthaMax Dry Media Filter - Red

**2013-15 Ram 2500/3500
6.7L Cummins Diesel**

Component Identification

1	Airaid Premium Filter	1
2	Airaid Intake Tube	1
3	Hump Hose	1
5	Hose Clamp	2

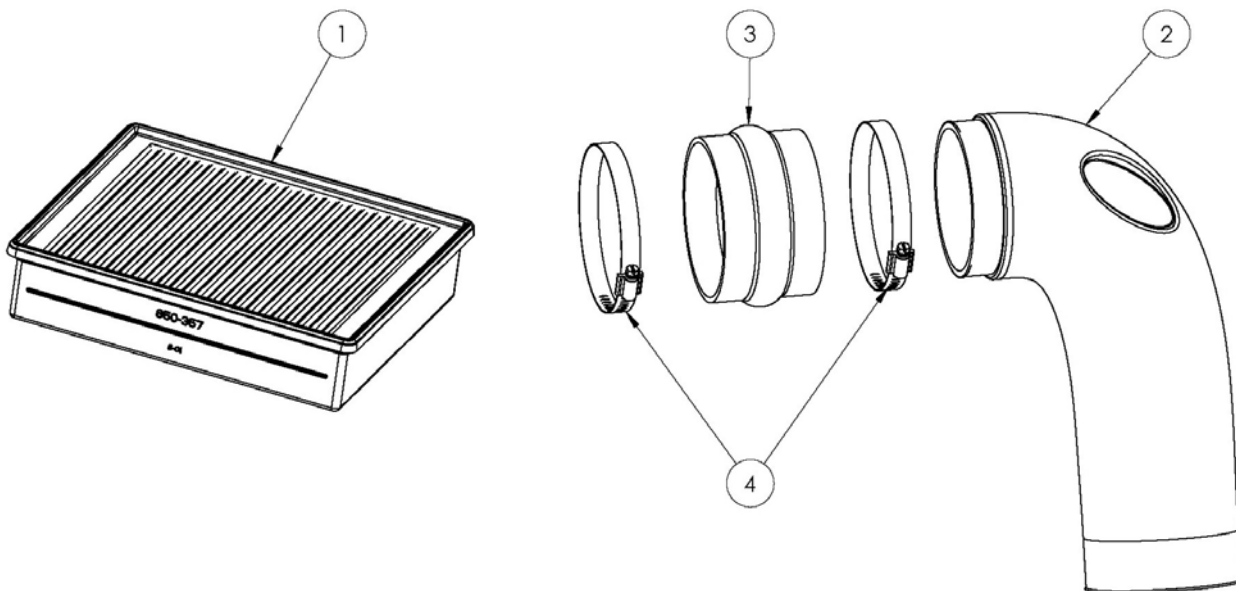

1. Disconnect The Negative Battery Terminals!
Warning: Installation of this Intake system requires working in close proximity to the turbocharger. Please allow a sufficient cooling time before beginning the installation to avoid personal injury.



2. Disconnect both of the air sensors in the airbox top.

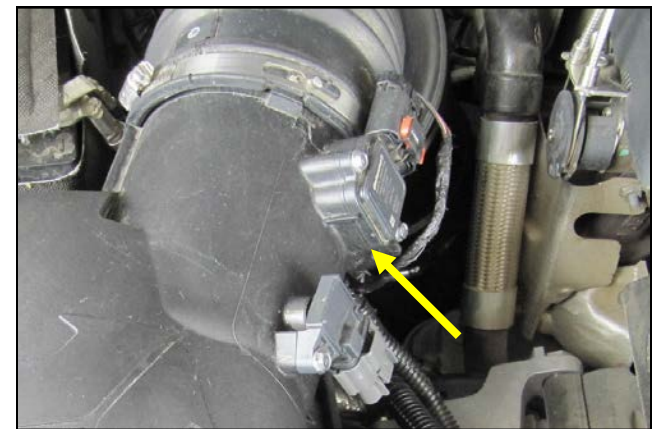

3. Gently pry the harness anchor out of its tab on the airbox and free the wire harness.



3. Loosen the clamp on the intake tube and remove the airbox lid from the vehicle.

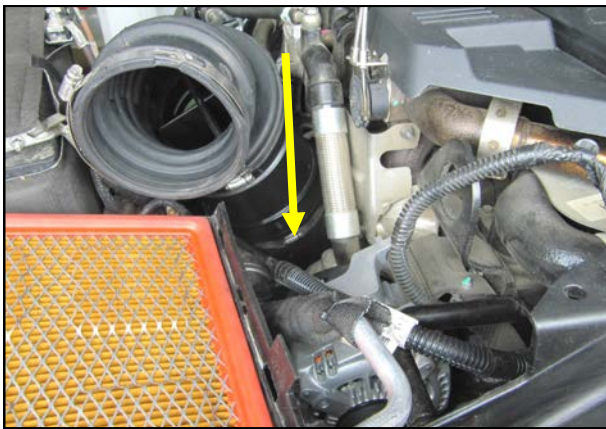

4. Loosen the intake clamp at the turbo inlet and remove the intake tube assembly.



5. Slide the Airaid intake tube into the turbo inlet but leave the clamp loose for now.

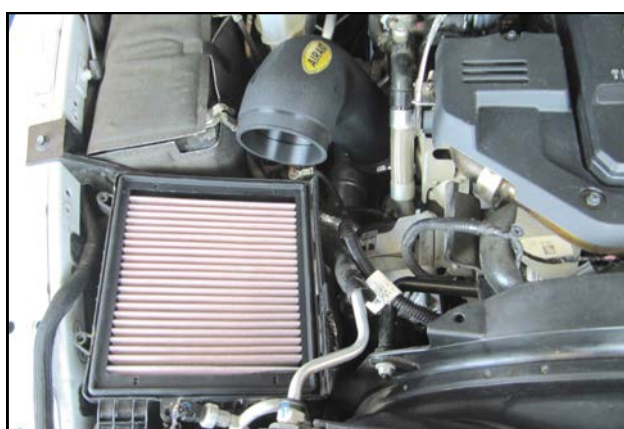

6. If you are installing an Airaid Jr. kit, install the Airaid Premium Filter at this time.



7. Slide the Hump Hose and clamps onto the Airaid Intake tube as shown.

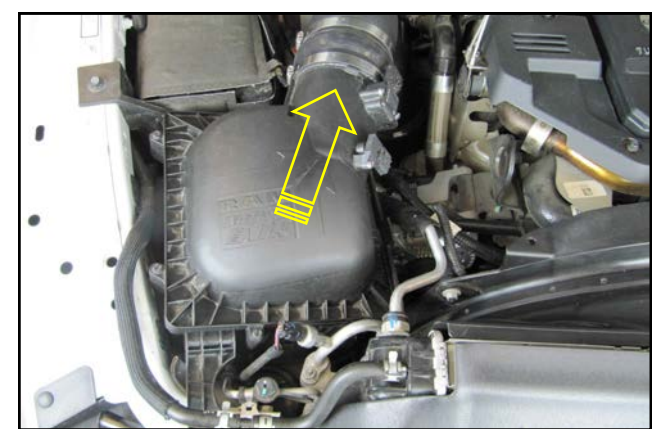

9. Slide the airbox outlet into the Hump hose and re-install the airbox lid.

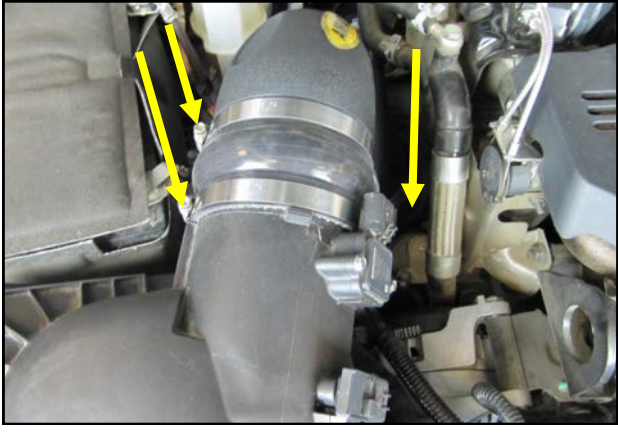

8. Tighten all three Intake Clamps at this time.

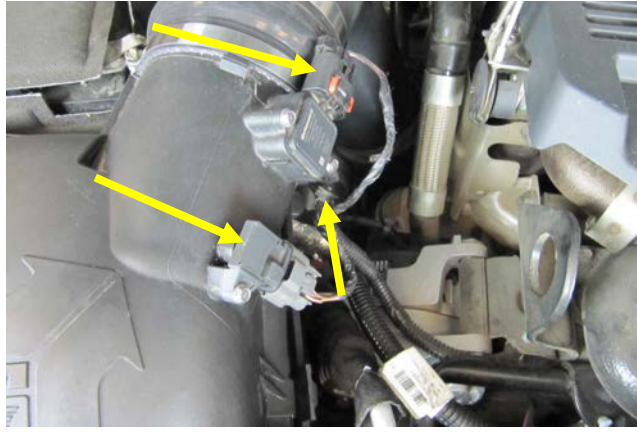

10. Reconnect the air sensors and harness anchor.



11. Double check your work. Make sure all Clamps are tight and reconnect the negative battery cables.