

Load**LIFTER** 5000™

U L T I M A T E

ADJUSTABLE AIR HELPER SPRINGS

TOW AND HAUL WITH SAFETY AND COMFORT™



Kit 88399

INSTALLATION GUIDE

For maximum effectiveness and safety, please read these instructions completely before proceeding with installation.

Failure to read these instructions can result in an incorrect installation.

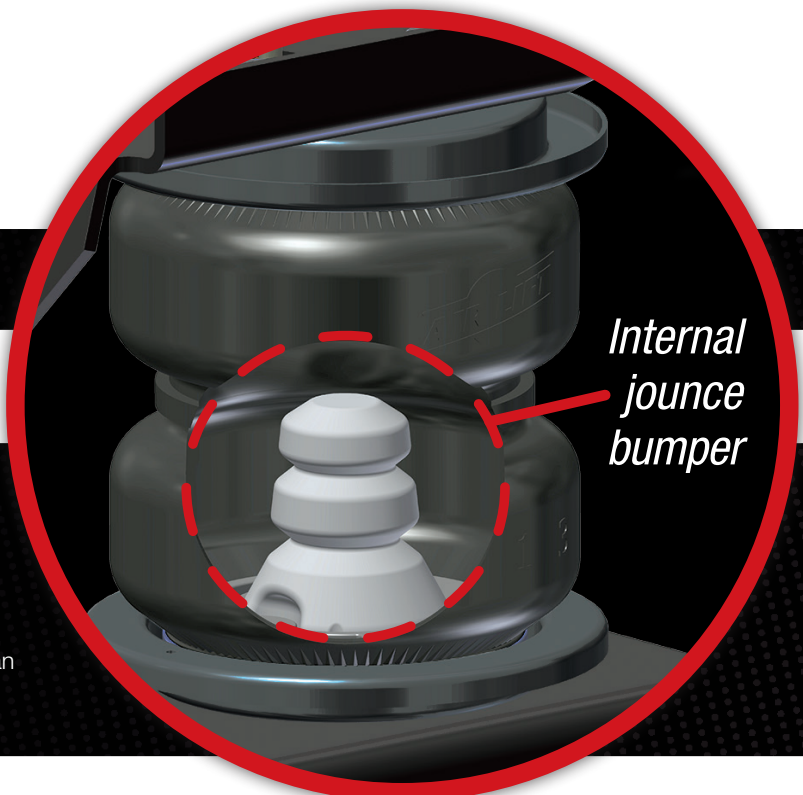

TABLE OF CONTENTS

A. Installation Diagram	2
B. Hardware and Tools Lists	3
Hardware List	3
Tools List	3
C. Introduction	4
Important Safety Notice	4
Notation Explanation	4
D. Installing the LoadLifter 5000 Ultimate System	5
Getting Started	5
Assembling the Air Spring	6
Installing the Assemblies	9
E. Installing the Air Lines	12
Tips for Installing Air Lines	13
Installing the Heat Shield	13
F. Finished Installation Photos	14
G. Before Operating	15
Checking for Leaks	15
Fixing Leaks	15
Installation Checklist	16
Post-Installation Checklist	16
H. Product Use, Maintenance and Servicing	17
Minimum and Maximum Pressure	17
Maintenance Guidelines	17
Tuning the Air Pressure	18
Guidelines for Adding Air	18
I. Troubleshooting Guide	19
Frequently Asked Questions	19

A. Installation Diagram

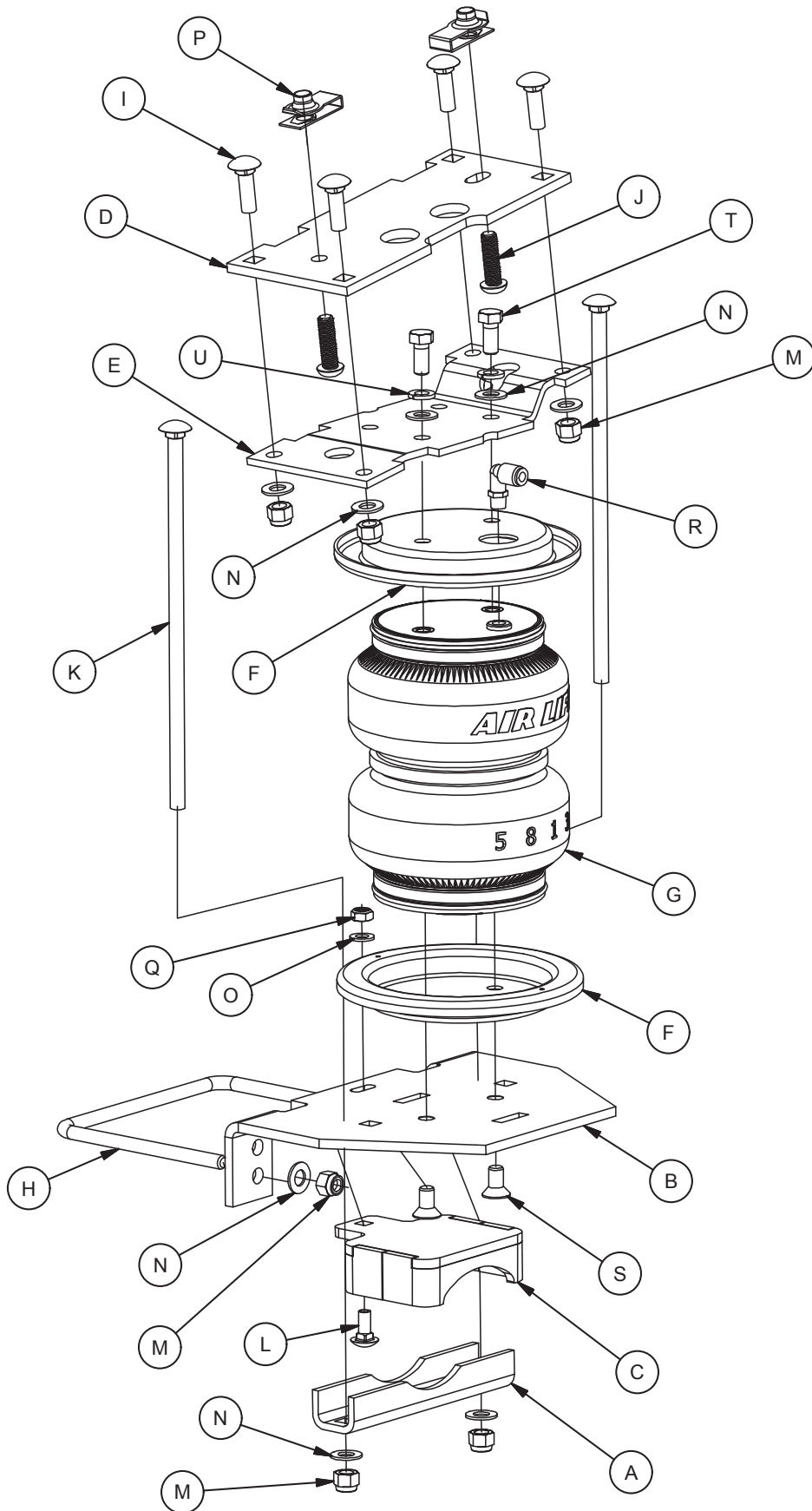

fig. A.1

B. Hardware and Tools Lists

HARDWARE LIST

Item	Part#	Description	Qty
A	01531	Clamp bars	2
B	03014	Lower brackets, main plate	2
C	03225	Lower brackets, cup	2
D	07045	Upper brackets, frame	2
E	07220	Upper brackets, air spring	2
F	11967	Roll plates	4
G	58496	Air springs	2
H	11770	U-bolts	2
I	17361	3/8"-16 x 1.25" Carriage bolts	8
J	17366	M10-1.5 x 35 Button head cap screw	4
K	17387	3/8"-16 x 10" Carriage bolts	4
L	17500	5/16"-18 x 3/4" Carriage bolts	2
M	18435	3/8"-16 Nylon lock nut	16
N	18444	3/8" Flat washer	20
O	18501	M8 Flat washer	2
P	18622	M10-1.5 Universal nut	4
Q	18613	5/16"-18 Nylon lock nut	2
R	21837	90° Swivel fitting	2
S	17215	3/8"-24 x 3/4" Flat head socket cap screw	4
T	17203	3/8"-24 x 7/8" Hex cap screw	4
U	18427	3/8" Lock washer	4
AA	20086	Hose assembly	1
BB	10466	Zip ties	6
CC	21230	Valve caps	2
DD	18501	5/16" Flat washers	2
EE	21234	Rubber washers	2
FF	18411	Small star washer	2
GG	21233	5/16" Hex nut	4

TOOLS LIST

Description	Qty
Metric & STD open-end box wrenches	set
Ratchet with metric and STD sockets	set
Drill and 5/16" drill bit	1
Torque wrench	1
Hex key wrenches metric and STD	set
Hose cutter, razor blade or sharp knife	1
Hoist or floor jack	1
Safety stands	2
Safety glasses	1
Air compressor or compressed air source	1
Spray bottle with dish soap/water solution	1

*** NOTE:** The pictures in this manual show the LoadLifter 5000 kit installation. Visually, the only difference is Ultimate kits have black roll plates and standard LoadLifter 5000 kits have silver roll plates.



LoadLifter 5000 Ultimate
black roll plate



LoadLifter 5000
silver roll plate

C. Introduction

The purpose of this publication is to assist with the installation, maintenance and troubleshooting of the LoadLifter 5000 Ultimate air spring kit. LoadLifter 5000 Ultimate utilizes sturdy, reinforced, commercial grade single or double, depending on the kit, convolute bellows. The bellows are manufactured like a tire with layers of rubber and cords that control growth. LoadLifter 5000 Ultimate kits are recommended for most 3/4- and 1-ton pickups and SUVs with leaf springs and provide up to 5,000 pounds of load-leveling support with air adjustability from 5-100 PSI. The kits are also used in motor home rear applications and various front applications where leaf springs are used.

It is important to read and understand the entire installation guide before beginning installation or performing any maintenance, service or repair. The information here includes a hardware list, tool list, step-by-step installation information, maintenance guidelines and operating tips.

Air Lift Company reserves the right to make changes and improvements to its products and publications at any time.

IMPORTANT SAFETY NOTICE

The installation of this kit does not alter the gross vehicle weight rating (GVWR) or payload of the vehicle. Check your vehicle's owner's manual and do not exceed the maximum load listed for your vehicle.

Gross vehicle weight rating: The maximum allowable weight of the fully loaded vehicle (including passengers and cargo). This number — along with other weight limits, as well as tire, rim size and inflation pressure data — is shown on the vehicle's Safety Compliance Certification Label.

Payload: The combined, maximum allowable weight of cargo and passengers that the truck is designed to carry. Payload is GVWR minus the base curb weight.

NOTATION EXPLANATION

Hazard notations appear in various locations in this publication. Information which is highlighted by one of these notations must be observed to help minimize risk of personal injury or possible improper installation which may render the vehicle unsafe. Notes are used to help emphasize areas of procedural importance and provide helpful suggestions. The following definitions explain the use of these notations as they appear throughout this guide.



INDICATES IMMEDIATE HAZARDS WHICH WILL RESULT IN SEVERE PERSONAL INJURY OR DEATH.



INDICATES HAZARDS OR UNSAFE PRACTICES WHICH COULD RESULT IN SEVERE PERSONAL INJURY OR DEATH.



INDICATES HAZARDS OR UNSAFE PRACTICES WHICH COULD RESULT IN DAMAGE TO THE MACHINE OR MINOR PERSONAL INJURY.

NOTE

Indicates a procedure, practice or hint which is important to highlight.

D. Installing the LoadLifter 5000 Ultimate System

GETTING STARTED

1. Raise the vehicle and support it in a way, using jack stands or equivalent, so that the axle can be safely dropped away from the frame. This needs to be done in order for the air spring assembly to be put into position between the axle and frame (Fig. D.1).

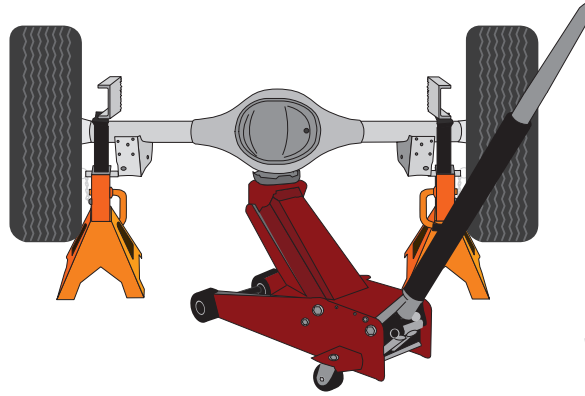

fig. D.1

2. Unbolt and remove the jounce bumper assembly from under the frame on both sides (Fig. D.2).



fig. D.2

3. Remove the clip-in studs by prying on the hinged end with a screwdriver. Pull all four – two from each side – out from the frame (Fig. D.3).

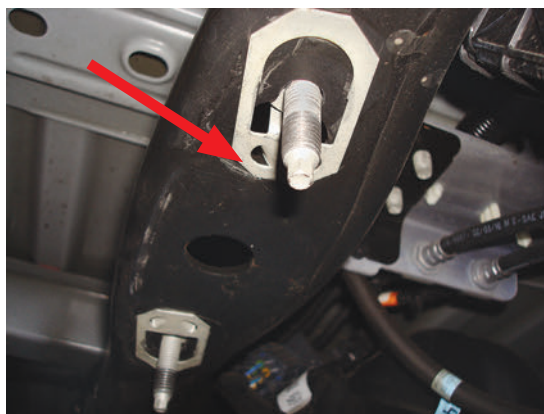

fig. D.3

4. Install the universal nuts (P) into the frame rail, lining up the holes in the frame and the threads in the nuts so that a bolt can be installed (Fig. D.4). **TECH TIP:** a flat-tip screwdriver works well in prying the universal nut into position.

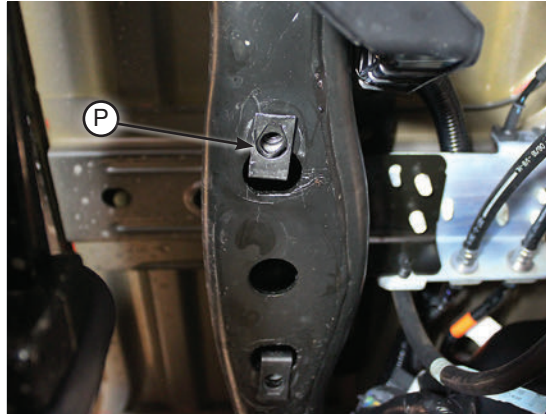

fig. D.4

5. Insert the 3/8"-16 x 1.25" carriage bolts (I) into the upper frame brackets (D) and install the upper bracket onto the frame using the M10-1.5 x 35 button head cap screws (J). The slot that is on the side of the bracket should be inboard of the frame rail (Fig. D.5 & 6). The elongated hole should be toward the front of the truck (Fig. D.6). Torque hardware to 38 lb.-ft. (52Nm).

This slot in the bracket goes inboard away from leaf spring and tire.

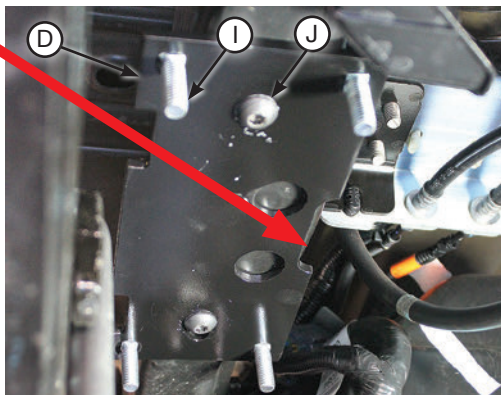

fig. D.5

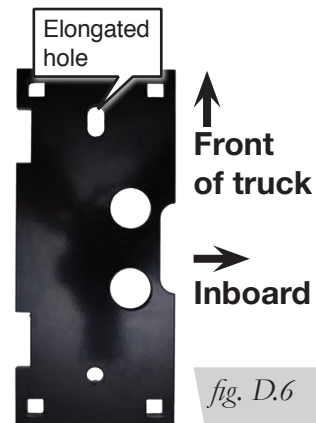

fig. D.6

ASSEMBLING THE AIR SPRING

1. Set a roll plate (F) on top of the air spring (G). The radiused, or rounded, edge of the roll plate should be toward the air spring so that it is seated inside the roll plate (Fig. D.7). Install the 90° swivel fitting (R) into the port on top of the air spring, finger tight plus 1 1/2 turns.

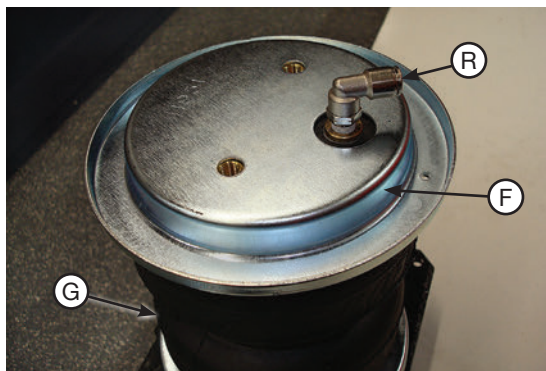

fig. D.7

- Set the upper air spring bracket (E) onto the top of the air spring using one set of holes with the 3/8"-24 x 7/8" hex cap screw (T), 3/8" lock washer (U) and 3/8" flat washer (N) (Fig D.8). Install the remaining air spring bracket onto the remaining air spring, using the opposite holes from those that were previously used. This makes the air spring assemblies into left- and right-hand units. Torque the hardware to no more than 20 lb.-ft. (27Nm).

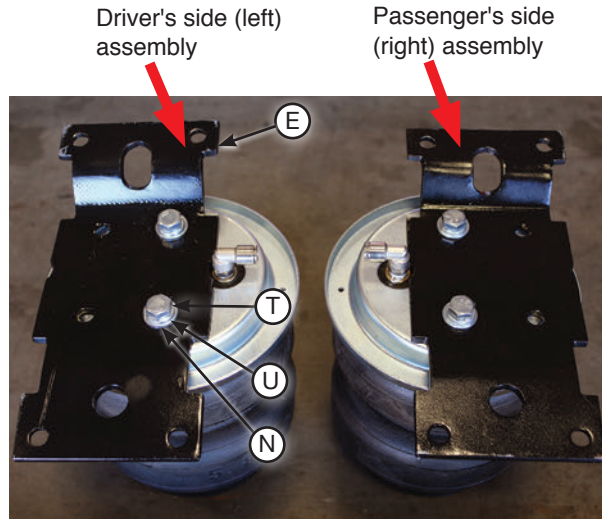

fig. D.8

- Flip the assemblies over and set a roll plate (F) onto the bottom of the air springs (Fig. D.9).



fig. D.9

- Insert two 3/8"-16 x 10" carriage bolts (K) through the square holes in the lower bracket main plate (B) (Fig. D.10).

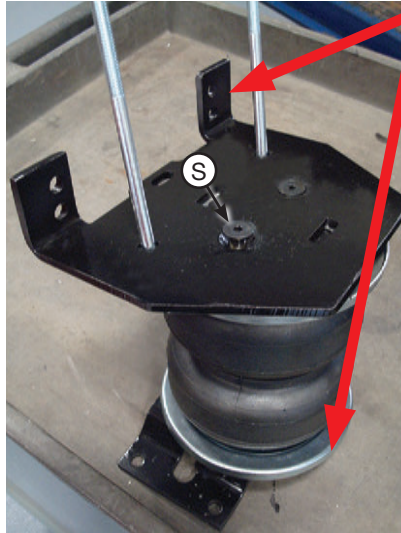

fig. D.10

- Set the lower bracket main plate assemblies onto the air springs with the roll plates installed. Attach with the 3/8"-24 x 3/4" flat head socket cap screws (S) (Fig. D.11). Torque the hardware to no more than 20 lb.-ft. (27Nm).

NOTE

The flange on the lower bracket must be on the opposite side of the fitting that is located on the top of the air spring.



The flanges on the lower bracket must be installed so they are on the opposite side of the fitting that is on the top of the air spring.

fig. D.11

- Install the lower bracket cup (C) onto the lower bracket main plate using the 5/16"-18 x 3/4" carriage bolt (L) (Fig. D.12). Cap with M8 flat washer (O) and 5/16"-18 nylon lock nut (Q) (Fig. D.13). Snug bolt down but leave loose enough for bracket to move freely in slot.

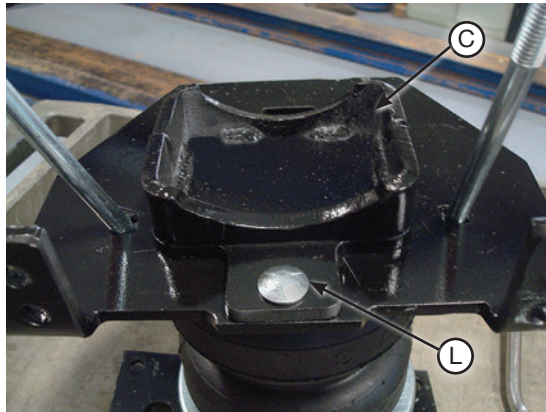

fig. D.12

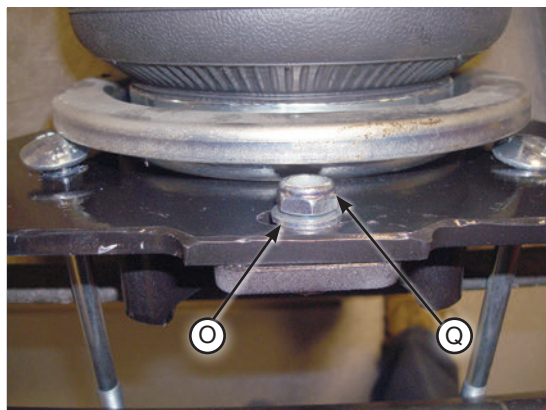
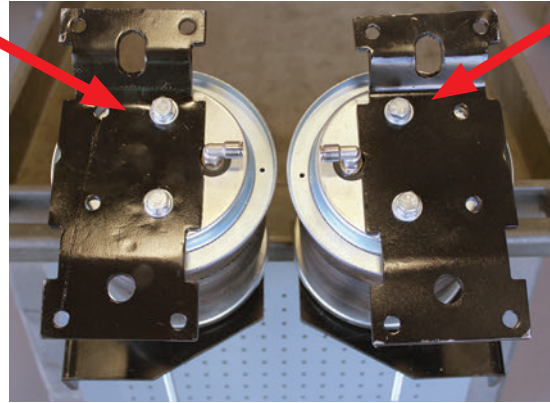

fig. D.13

7. Figure D.14 shows the driver's (left) and passenger's (right) side assemblies.

Driver's side
(left) assembly



Passenger's side
(right) assembly

fig. D.14

INSTALLING THE ASSEMBLIES

1. With the vehicle supported by jack stands, drop the axle or raise the body so that the assemblies can be put into position in between the axle and frame. Set the driver's side (left) and passenger's side (right) assemblies into position so that the lower bracket cup rests on the jounce bumper strike plate. Push the lower bracket so that it is flush against the leaf spring stack. The flanges on the lower bracket main plate should lock on the sides of the U-bolt (Fig. D.15).

NOTE

On the driver's side (left), the long carriage bolt in the lower bracket main plate should be located between the hard brake line and axle (Fig. D.20). On the passenger's side (right), the carriage bolt should be located on the backside of the brake line (Fig. D.21).

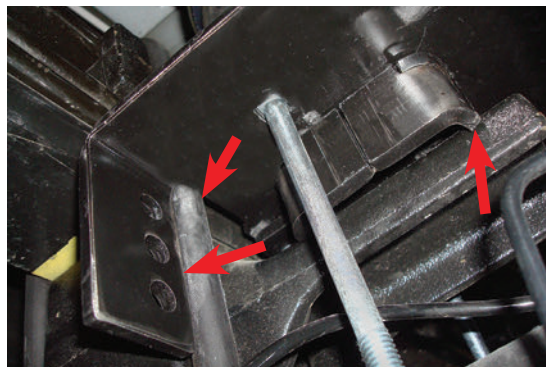

fig. D.15

2. Install the U-bolts (H) around the jounce bumper strike plate/spacer blocks and insert through the topmost holes in the lower bracket main plates (Fig. D.16). Cap with the 3/8" flat washers (N) and 3/8"-16 nylon lock nuts (M). Snug bolts evenly, just enough to hold the lower bracket main plate flush against the stock U-bolts.

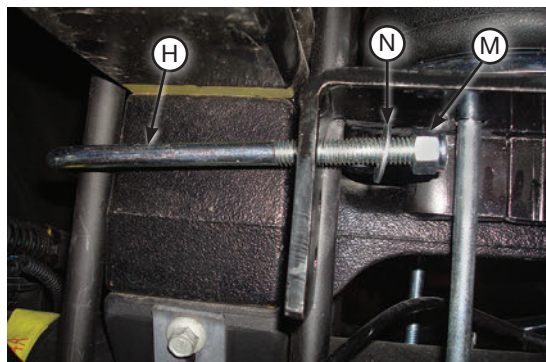

fig. D.16

- Set the lower clamp bars (A) over the carriage bolts located under the axle (Fig. D.17). Attach with the 3/8" flat washers (N) and 3/8"-16 nylon lock nuts (M). Evenly torque the lower clamp bar hardware to 16 lb.-ft. (22Nm). Finish tightening the U-bolt hardware previously snugged by torquing to 10 lb.-ft. (14Nm).

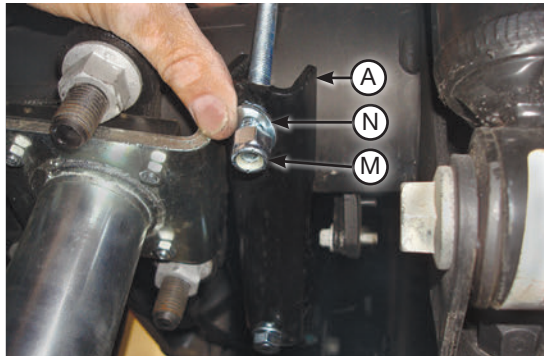

fig. D.17

- On vehicles with an anti-roll bar, it might be necessary to cut the rear carriage bolt so it does not contact the anti-roll bar (Fig. D.18).

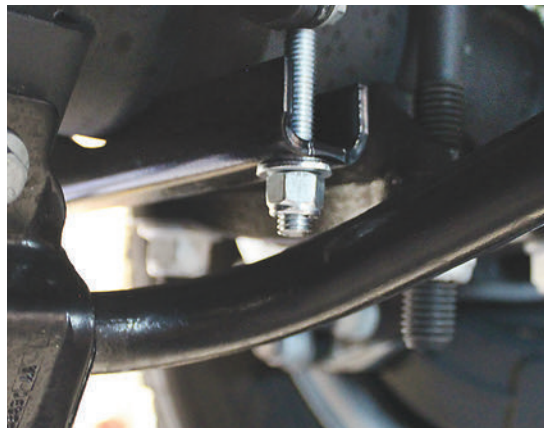

fig. D.18

- Snug the nut that holds the lower bracket main plate and lower bracket cup together to finish the lower bracket installation (Fig. D.19).

NOTE

This nut will be difficult to tighten. It may be necessary to flip the wrench over a couple times and/or move from the front/back side of the axle to get this tightened.



fig. D.19

6. Figures D.20 & D.21 show the lower bracket installed.

Driver's side (left) assembly

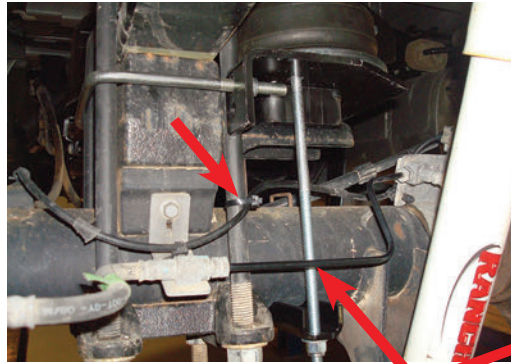

fig. D.20

Passenger's side (right) assembly

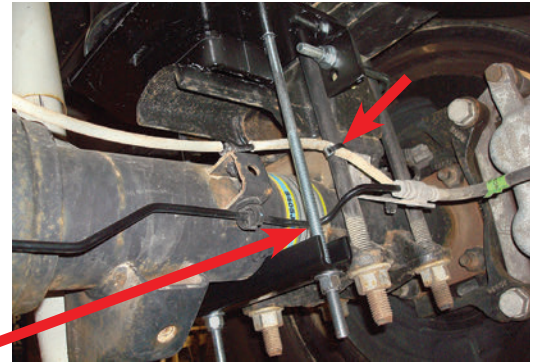

fig. D.21

If the hard brake line is resting on the lower bracket carriage bolt on either side, push or pull the brake line out of the way.

7. Finish the lower bracket install by tying off the ABS lines with zip ties (BB) so that they will not chafe on the lower bracket carriage bolts.



CAUTION

IT WILL BE NECESSARY TO PUSH THE HARD BRAKE LINE AWAY FROM THE LOWER BRACKET CARRIAGE BOLT IF THE LINE IS RESTING ON IT (FIGS D.20 & D.21).

8. Before proceeding, make sure that the 90° fittings are pointing inboard toward the center of the vehicle. While raising or lowering the axle or body of the vehicle, align the previously installed upper air spring bracket carriage bolts with the frame bracket so the carriage bolts protrude through the bracket. Cap the carriage bolts with the 3/8" flat washers (N) and 3/8"-16 nylon lock nuts (M) (Fig. D.22). Snug the nuts down first then torque to 31 lb.-ft. (42Nm). Raise the axle or lower the body and remove jack stands.

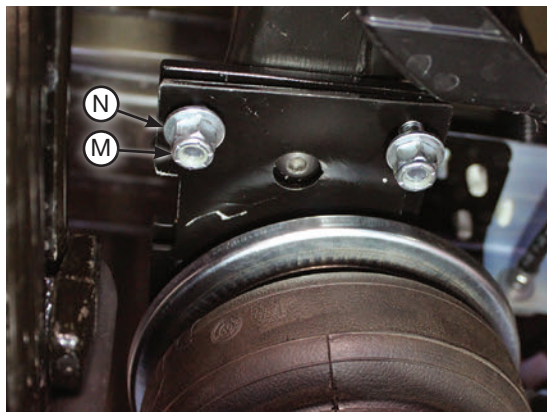

fig. D.22

E. Installing the Air Lines

This section explains how to set up the air spring kit to be controlled with Schrader valves and a separate compressed air source. An on-board air compressor system allows for hassle-free control of the air springs.

1. Before installing the passenger's side (right) air line, install the hose heat shield over the hose (Fig. E.1). Once the air line has been inserted into the fitting, align the heat shield so that it is protecting the air line from the exhaust pipe. Secure the air line to the frame with zip ties.

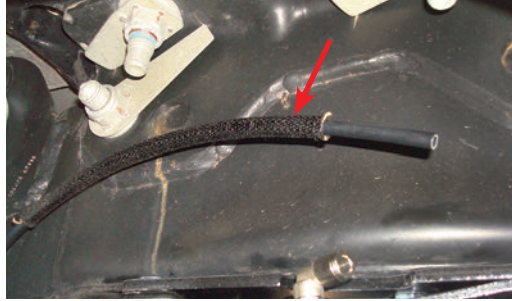

fig. E.1

2. Choose a convenient location for mounting the inflation valves. Popular locations for the inflation valve are:
 - a. The wheel well flanges
 - b. The license plate recess in bumper
 - c. Under the gas cap access door
 - d. Through the license plate

NOTE

Whatever the chosen location, make sure there is enough clearance around the inflation valves for an air chuck.

3. Drill 5/16" holes to install the inflation valves.
4. Cut the air line assembly in two equal lengths.
5. Place a 5/16" nut and star washer on the air valve. Leave enough of the inflation valve in front of the nut to extend through the hole and have room for the rubber washer, flat washer, and 5/16" nut and cap. There should be enough valve exposed after installation – approximately 1/2" – to easily apply a pressure gauge or an air chuck (Fig. E.2).

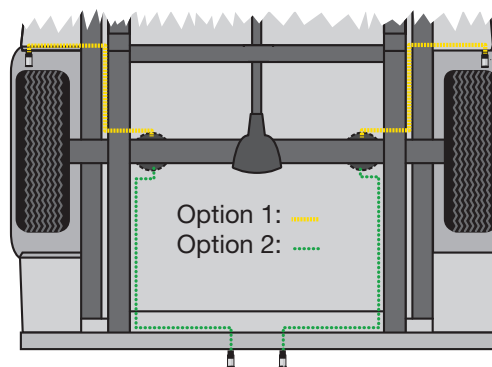

fig. E.2

6. Push the inflation valve through the hole and use the rubber washer, flat washer, and another 5/16" nut to secure it in place. Tighten the nuts to secure the assembly.

- Route the air line along the frame to the air spring fitting (Fig. E.3). Keep AT LEAST 6" of clearance between the air line and the exhaust system. Avoid sharp bends and edges. Use zip ties to secure the air line to fixed points along the chassis. Do not pinch the air line. Leave at least 2" of slack to allow for any movement that might pull on the air line.

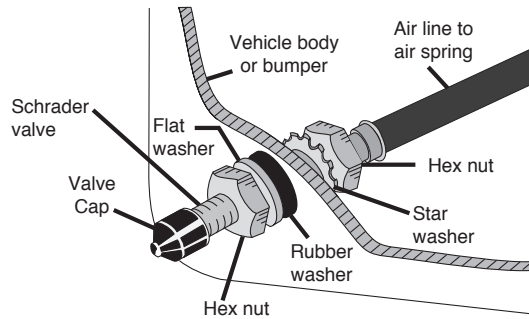

fig. E.3

- Cut off the air line, leaving approximately 12" of extra air line. A clean square cut will prevent leaks. Insert the air line into the air fitting. This is a push-to-connect fitting. Simply push the air line into the 90° swivel fitting until it bottoms out (9/16" of air line should be in the fitting).

TIPS FOR INSTALLING AIR LINES

When cutting air lines, use a sharp knife or a hose cutter and make clean, square cuts (Fig. E.4). Do not use scissors or wire cutters because these tools may deform the air line, causing it to leak around fittings. Do not cut the lines at an angle.

Do not bend the 1/4" hose at a radius of less than 1" or bend the 3/8" hose at a radius of less than 1 1/2". Do not put side load pressure on fitting. The hose should be straight beyond the fitting for 1" before bending.

Inspect hose for scratches that run lengthwise on hose prior to installation.

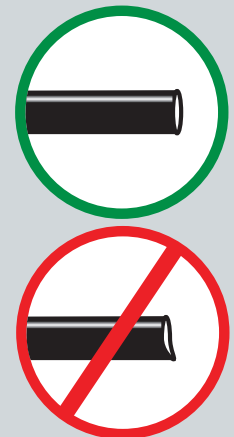

fig. E.4

INSTALLING THE HEAT SHIELD

- Bend tabs to provide a dead air space between exhaust pipe and heat shield (Figs. E.5 & E.6). Attach the heat shield to the exhaust pipe using the clamps. Bend the heat shield for maximum clearance to the air spring.

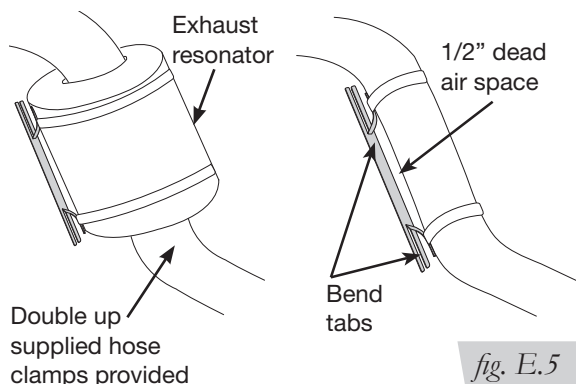

fig. E.5

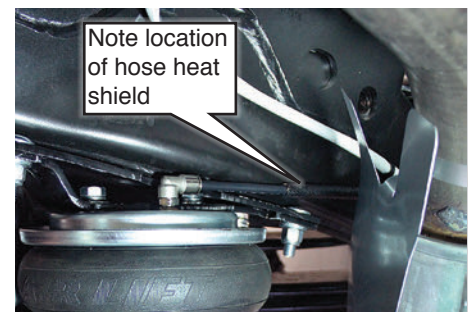

fig. E.6

F. Finished Installation Photos

1. These images show the finished installation of both sides (Figs. F.1, F.2, F.3 & F.4).



Passenger's side (right) front view of kit installed.



Passenger's side (right) inside frame view of kit installed.

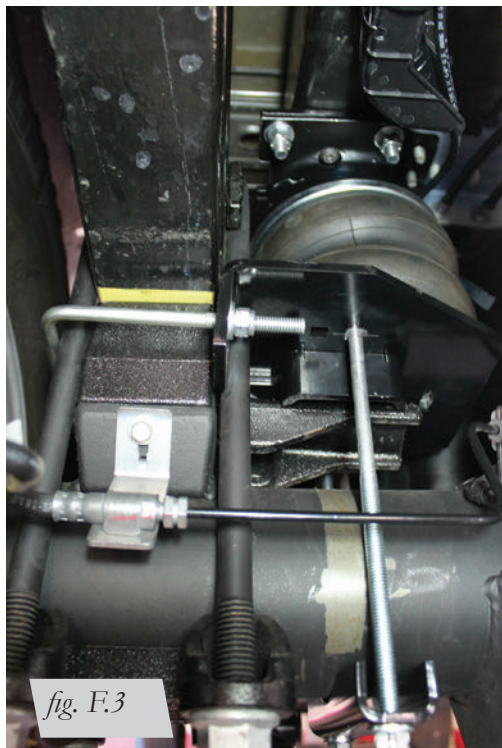

Driver's side (left) rear view of kit installed.

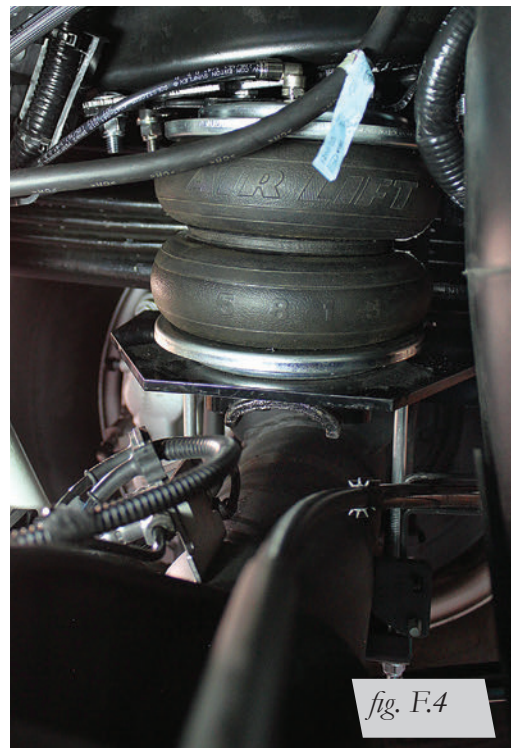

Driver's side (left) inside frame view of kit installed.

G. Before Operating

CHECKING FOR LEAKS

1. Inflate the air spring to 30 PSI.
2. Spray all connections and the inflation valves with a solution of 1/5 liquid dish soap and 4/5 water. Spot leaks easily by looking for bubbles in the soapy water.
3. After the test, deflate the springs to the minimum pressure required to restore the system to normal ride height. Do not deflate to lower than 5 PSI.
4. Check the air pressure again after 24 hours. A 2-4 PSI loss after initial installation is normal. Retest for leaks if the loss is more than 5 PSI.

FIXING LEAKS

1. If there is a problem with the swivel fitting:
 - a. Check the air line connection by deflating the spring and removing the line by pulling the collar against the fitting and pulling firmly on the air line. Trim 1" off the end of the air line. Be sure the cut is clean and square (see Fig. E.4). Reinsert the air line into the push-to-connect fitting.
 - b. Check the threaded connection by tightening the swivel fitting another half turn. If it still leaks, deflate the air spring, remove the fitting, and re-coat the threads with thread sealant. Reinstall by hand tightening as much as possible and then use a wrench for an additional two turns.
2. If there is a problem with the inflation valve:
 - a. Check the valve core by tightening it with a valve core tool.
 - b. Check the air line by removing the air line from the barbed type fitting. Cut the air line off a few inches in front of the fitting and use a pair of pliers or vice grips to pull/twist the air line off of the fitting.



CAUTION

DO NOT CUT OFF THE AIR LINE COMPLETELY AS THIS WILL USUALLY NICK THE BARB AND RENDER THE FITTING USELESS.

3. If the preceding steps have not resolved the problem, call Air Lift customer service.

INSTALLATION CHECKLIST

- Clearance test** — Inflate the air springs to 75-90 PSI and make sure there is at least 1/2" clearance from anything that might rub against each air spring. Be sure to check the tire, brakes, frame, shock absorbers and brake cables.
- Leak test before road test** — Inflate the air springs to 75-90 PSI and check all connections for leaks. All leaks must be eliminated before the vehicle is road tested.
- Heat test** — Be sure there is sufficient clearance from heat sources, at least 6" for air springs and air lines. If a heat shield was included in the kit, install it. If there is no heat shield, but one is required, call Air Lift customer service.
- Fastener test** — Recheck all bolts for proper torque.
- Road test** — The vehicle should be road tested after the preceding tests. Inflate the springs to recommended driving pressures. Drive the vehicle 10 miles and recheck for clearance, loose fasteners and air leaks.
- Operating instructions** — If professionally installed, the installer should review the operating instructions with the owner. Be sure to provide the owner with all of the paperwork that came with the kit.

POST-INSTALLATION CHECKLIST

- Overnight leak down test** — Recheck air pressure after the vehicle has been used for 24 hours. If the pressure has dropped more than 5 PSI, then there is a leak that must be fixed. Either fix the leak yourself or return to the installer for service.
- Air pressure requirements** — It is important to understand the air pressure requirements of the air spring system. Regardless of load, the air pressure should always be adjusted to maintain adequate ride height at all times while driving.
- Thirty-day or 500-mile test** — Recheck the air spring system after 30 days or 500 miles, whichever comes first. If any part shows signs of rubbing or abrasion, the source should be identified and moved, if possible. If it is not possible to relocate the cause of the abrasion, the air spring may need to be remounted. If professionally installed, the installer should be consulted. Check all fasteners for tightness.

H. Product Use, Maintenance and Servicing

Minimum Recommended Pressure	Maximum Air Pressure
5 PSI	100 PSI

MAINTENANCE GUIDELINES

NOTE

By following the steps below, vehicle owners will obtain the longest life and best results from their air springs.

1. Check air pressure weekly.
2. Always maintain normal ride height. Never inflate beyond 100 PSI.
3. If you develop an air leak in the system, use a soapy water solution (1/5 liquid dish soap and 4/5 water) to check all air line connections and the inflation valve core before deflating and removing the air spring.

CAUTION

FOR SAFETY AND TO PREVENT POSSIBLE DAMAGE TO THE VEHICLE, DO NOT EXCEED MAXIMUM GROSS VEHICLE WEIGHT RATING (GVWR), AS INDICATED BY THE VEHICLE MANUFACTURER. ALTHOUGH THE AIR SPRINGS ARE RATED AT A MAXIMUM INFLATION PRESSURE OF 100 PSI, THE AIR PRESSURE ACTUALLY NEEDED IS DEPENDENT ON LOAD AND GVWR.

4. Loaded vehicles require at least 25 PSI. A “loaded vehicle” refers to a vehicle with a heavy bed load, a trailer or both. Never exceed GVWR, regardless of air spring, air pressure or other load assist. The springs in this kit will support approximately 40 pounds of load (combined on both springs) for each 1 PSI of pressure. The required air pressure will vary depending on the state of the original suspension. Operating the vehicle below the minimum air spring pressure will void the Air Lift warranty.
5. When increasing load, always adjust air pressure to maintain normal ride height. Increase or decrease pressure from the system as necessary to attain normal ride height for optimal ride and handling. Remember that loads carried behind the axle (including tongue loads) require more leveling force (pressure) than those carried directly over the axle.
6. Always add air to springs in small quantities, checking the pressure frequently.
7. Should it become necessary to raise the vehicle by the frame, make sure the system is at minimum pressure (5 PSI) to reduce the tension on the suspension/ brake components. Use of on-board leveling systems do not require deflation or disconnection.
8. Periodically check the air spring system fasteners for tightness. Also, check the air springs for any signs of rubbing. Realign if necessary.
9. On occasion, give the air springs a hard spray with a garden hose to remove mud, sand, gravel or other debris.

TUNING THE AIR PRESSURE

Pressure determination comes down to three things — level vehicle, ride comfort and stability.

1. Level vehicle

If the vehicle's headlights are shining into the trees or the vehicle is leaning to one side, then it is not level (Fig. H.1). Raise the air pressure to correct either of these problems and level the vehicle.

2. Ride comfort

If the vehicle has a rough or harsh ride it may be due to either too much pressure or not enough (Fig. H.2). Try different pressures to determine the best ride comfort.

3. Stability

Stability translates into safety and should be the priority, meaning the driver may need to sacrifice a perfectly level and comfortable ride. Stability issues include roll control, bounce, dive during braking and sponginess (Fig. H.3). Tuning out these problems usually requires an increase in pressure.

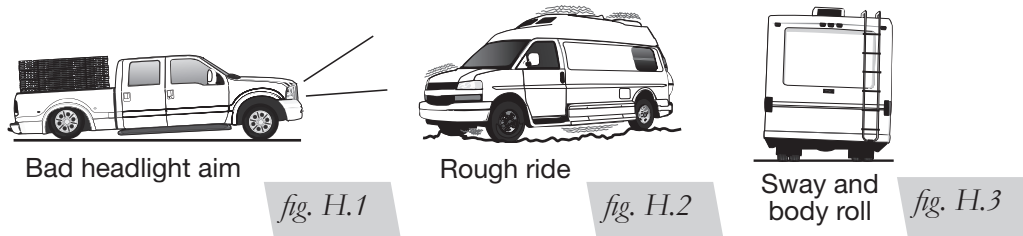

GUIDELINES FOR ADDING AIR

1. Start with the vehicle level or slightly above.
2. When in doubt, always add air.
3. If the front of the vehicle dives while braking, increase the pressure in the front air bags, if equipped.
4. If it is ever suspected that the air bags have bottomed out, increase the pressure (Fig. H.4).
5. Adjust the pressure up and down to find the best ride.
6. If the vehicle rocks and rolls, adjust the air pressure to reduce movement.
7. It may be necessary to maintain different pressures on each side of the vehicle. Loads such as water, fuel, and appliances will cause the vehicle to be heavier on one side (Fig. H.5). As much as a 50 PSI difference is not uncommon.

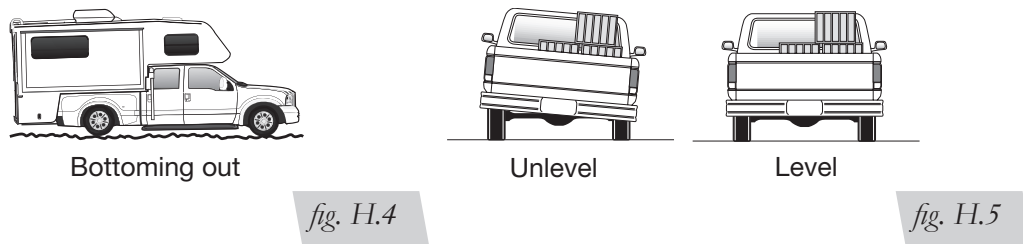

I. Troubleshooting Guide

PROBLEM	CAUSE	SOLUTION
System won't maintain pressure overnight.	Improperly installed air line, air line has holes or cracks.	Leak test the air line connections, the threaded connection into the air spring, and all fittings in the control system.
Air spring or hose leak.	Fitting seal or air line is compromised.	Check to make sure air lines are seated in connectors. Inspect fittings with soapy water. Trim hose or re-seal fitting. Ensure lines are cut straight.
Corner won't raise or air leak develops.	Look for a kink or fold in the air line.	Replace any air line that has been kinked.

FREQUENTLY ASKED QUESTIONS

Q. Will installing air springs increase the weight ratings of a vehicle?

No. Adding air springs will not change the weight ratings (GAWR, GCWR and/or GVWR) of a vehicle. Exceeding the GVWR is dangerous and voids the Air Lift warranty.

Q. Is it necessary to keep air in the air springs at all times and how much pressure will they need?

For LoadLifter 5000 Ultimate, the recommended minimum air pressure is 5 PSI, but it can safely be run at zero air pressure in an unladen condition.

Q. Is it necessary to add a compressor system to the air springs?

No. Air pressure can be adjusted with any type of compressor as long as it can produce sufficient pressure to service the springs. Even a bicycle tire pump can be used, but it's a lot of work.

Q. How long should air springs last?

If the air springs are properly installed and maintained they can last indefinitely.

Q. Will raising the vehicle on a hoist for service work damage the air springs?

No. The vehicle can be lifted on a hoist for short-term service work such as tire rotation or oil changes. However, if the vehicle will be on the hoist for a prolonged period of time, support the axle with jack stands in order to take the tension off of the air springs.