

Load**LIFTER** 5000™

ULTIMATE

ADJUSTABLE AIR HELPER SPRINGS

TOW AND HAUL WITH SAFETY AND COMFORT™



Kit Number
88286

INSTALLATION GUIDE

For maximum effectiveness and safety, please read these instructions completely before proceeding with installation.

Failure to read these instructions can result in an incorrect installation.

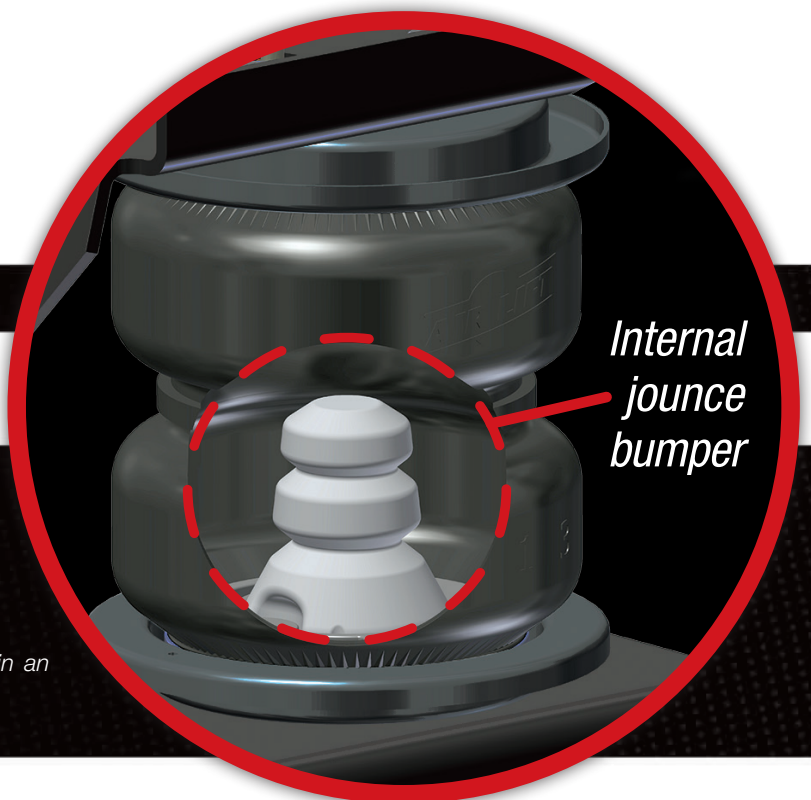

TABLE OF CONTENTS

Introduction	2
Important Safety Notice	2
Notation Explanation	2
Installation Diagram	3
Hardware List	4
Installing the LoadLifter 5000 Ultimate System	4
Getting Started	5
Assembling the Air Spring	5
Setting the Assembly in Place	6
Securing the Emergency Brake Cable	9
Installing the Air Lines	10
Installing the Heat Shield	11
Checking for Leaks	11
Fixing Leaks	12
Before Operating	13
Installation Checklist	13
Post-Installation Checklist	13
Product Use, Maintenance and Servicing	14
Minimum and Maximum Pressure	14
Maintenance Guidelines	14
Troubleshooting Guide	14
Frequently Asked Questions	15
Tuning the Air Pressure	15
Guidelines for Adding Air	16
Choosing the Right On-Board Air Compressor System	17
Warranty and Returns Policy	18
Replacement Information	19
Contact Information	19

Introduction

The purpose of this publication is to assist with the installation, maintenance and troubleshooting of the LoadLifter 5000 Ultimate air spring kit. LoadLifter 5000 Ultimate utilizes sturdy, reinforced, commercial grade single or double, depending on the kit, convolute bellows. The bellows are manufactured like a tire with layers of rubber and cords that control growth. An internal jounce bumper inside the spring absorbs shock and eliminates harsh jarring on rough roads. The internal jounce bumper replaces the factory bumper and allows the air springs to safely be run at zero air pressure. LoadLifter 5000 Ultimate kits are recommended for most ¾ and 1 ton pickups and SUVs with leaf springs and provide up to 5,000 lbs. of load leveling support with air adjustability from 5-100 PSI. The kits are also used in motorhome rear kits and some motorhome fronts where leaf springs are used.

It is important to read and understand the entire installation guide before beginning installation or performing any maintenance, service or repair. The information here includes a hardware list, tool list, step-by-step installation information, maintenance tips, safety information and a troubleshooting guide.

IMPORTANT SAFETY NOTICE

The installation of this kit does not alter the Gross Vehicle Weight Rating (GVWR) or payload of the vehicle. Check your vehicle's owner's manual and do not exceed the maximum load listed for your vehicle.

Gross Vehicle Weight Rating: The maximum allowable weight of the fully loaded vehicle (including passengers and cargo). This number — along with other weight limits, as well as tire, rim size and inflation pressure data — is shown on the vehicle's Safety Compliance Certification Label.

Payload: The combined, maximum allowable weight of cargo and passengers that the vehicle is designed to carry. Payload is GVWR minus the Base Curb Weight.

NOTATION EXPLANATION

Hazard notations appear in various locations in this publication. Information which is highlighted by one of these notations must be observed to help minimize risk of personal injury or possible improper installation which may render the vehicle unsafe. Notes are used to help emphasize areas of procedural importance and provide helpful suggestions. The following definitions explain the use of these notations as they appear throughout this guide.

INDICATES IMMEDIATE HAZARDS WHICH WILL RESULT IN SEVERE PERSONAL INJURY OR DEATH.

 **DANGER**

INDICATES HAZARDS OR UNSAFE PRACTICES WHICH COULD RESULT IN SEVERE PERSONAL INJURY OR DEATH.

 **WARNING**

INDICATES HAZARDS OR UNSAFE PRACTICES WHICH COULD RESULT IN DAMAGE TO THE MACHINE OR MINOR PERSONAL INJURY.

 **CAUTION**

NOTE

Indicates a procedure, practice or hint which is important to highlight.

Installation Diagram

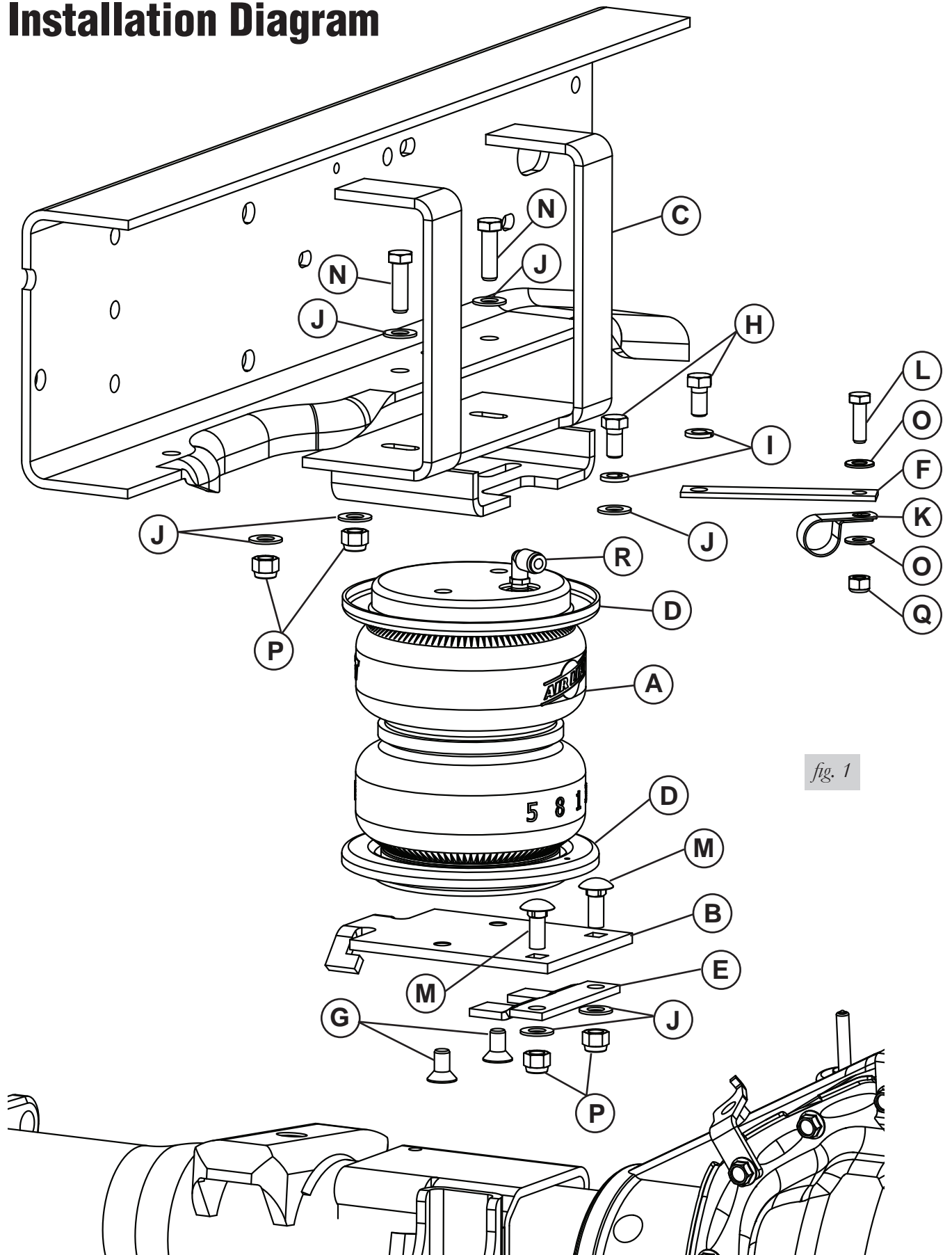

fig. 1



HARDWARE LIST

Item	Part #	Description	Qty
A	58496	Bellows.....	2
B	03253	Lower Bracket.....	2
C	07990	Upper Bracket.....	2
D	11967	Roll Plate.....	4
E	03267	Clamp.....	2
F	11041	Emergency Brake Cable Bracket.....	1
G	17215	3/8-24 x 3/4 Flat Head Screw	4
H	17203	3/8-24 x 7/8 Hex Cap Screw	4
I	18427	3/8" Lock Washer.....	4
J	18444	3/8" Flat Washer	15
K	10465	5/8" Clip.....	1
L	17103	5/16-18 x 1 Hex Cap Screw.....	1
M	17134	3/8-16 x 1 Carriage Bolt.....	4
N	17188	3/8-16 x 1.25 Hex Cap Screw	4
O	18433	5/16" Flat Washer	2
P	18435	3/8-16 Nyloc Nut	8
Q	18438	5/16-18 Nyloc Nut	1
R	21837	90° Swivel Elbow Fitting.....	2
S	20086	Air Line Assembly	1
T	10466	Tie Strap	6
U	18501	M8 Flat Washer.....	2
V	18411	Small Star Washer	2
W	21230	Valve Caps.....	2
X	21233	5/16-32 Hex Nut.....	4
Y	21234	Rubber Washer.....	2
Z	34365	Heat Shield	1

TOOLS LIST

Description
Safety Glasses
Hoist or Floor Jack
Jack Stands
Standard & Metric Sockets and Wrenches
Air Compressor or Compressed Air Source
Spray Bottle with Dish Soap/Water Solution
Hose Cutter, Razor Blade or Sharp Knife
Drill and 5/16" Drill Bit

Installing the LoadLifter 5000 Ultimate System

GETTING STARTED

1. Raise the vehicle and support the frame with jack stands. Lower the axle as far as it can go.
2. Remove the Jounce Bumpers from the frame that are above the axle.

ASSEMBLING THE AIR SPRING

1. Set the roll plates (D) on both sides of the Bellows (A). The radius (rounded edge) of the roll plate will be towards the air spring, so both ends are seated in both roll plates (fig. 1).
2. Install the 90° swivel elbow fitting (R) to the top of the bellows (A). Tighten finger tight plus 1 and a ½ turns. Be careful to only tighten on the hex nut. Do not over tighten.
3. Driver Side: install the upper bracket to the bellows assembly using two 3/8" bolts (H), lock washers (I), with one flat washers (J) on the rear bolt, and the Emergency Brake cable bracket (F) on the forward bolt (fig. 2). Leave bolts loose at this time.
4. Passenger Side: install the upper bracket to the bellows assembly using two 3/8" bolts (H), lock washers (I), flat washers (J). Leave the bolts loose at this time.

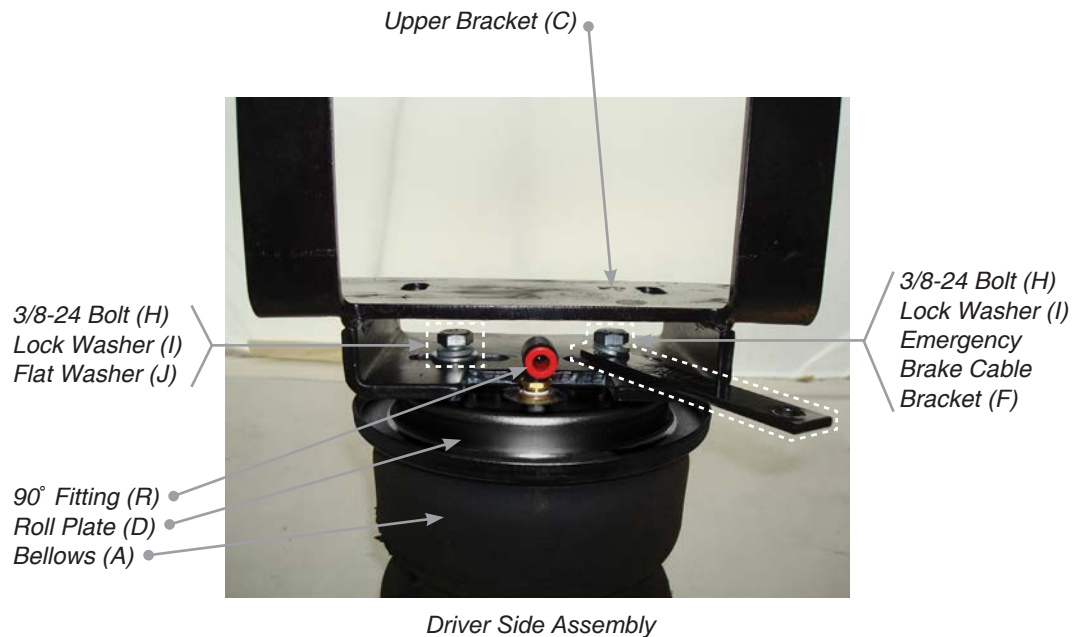
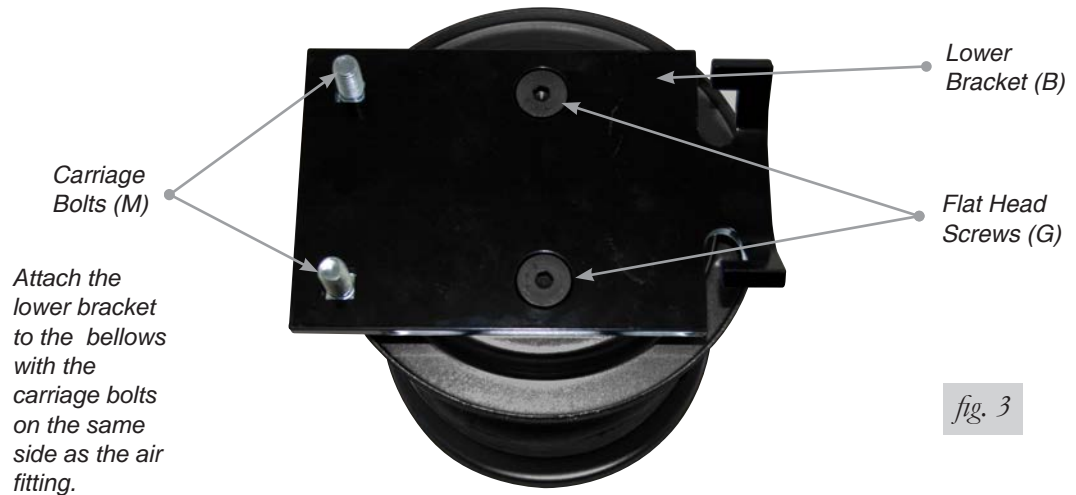

fig. 2

5. Insert two 3/8 carriage bolts (M) into the lower bracket (B) opposite end of the "tabs" that are on one end. Attach the lower bracket to the bellows assembly using two 3/8 Flat Head Screws (G) and tighten securely.

NOTE

The end with the carriage bolts in the lower bracket will be on the same side as the fitting (fig. 3).



SETTING THE ASSEMBLY IN PLACE

The assembly with the emergency brake cable bracket mounts on the driver side. Install both sides together throughout the installation (not one at a time).

1. Set the clamp (E) into position under the jounce bumper strike plate that is welded to the axle (fig. 4).

NOTE

It may be necessary to pry the bracket into position.

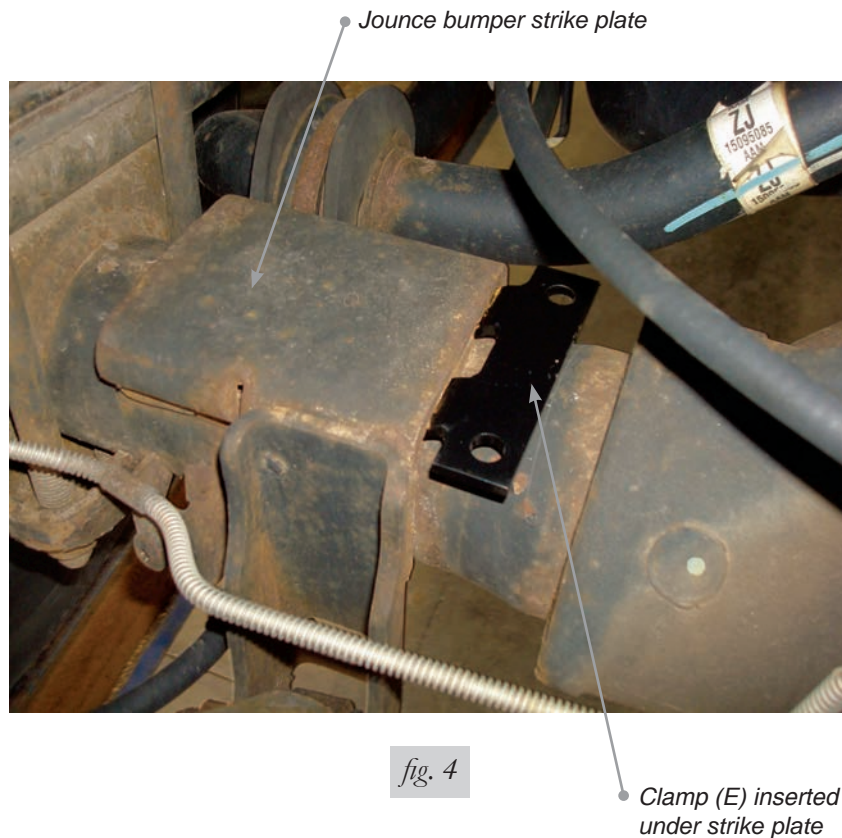

2. Set the driver side assembly in place over the axle. The “tabs” that are on the outside of the lower bracket will index under the jounce bumper strike plate (fig. 5).

NOTE

It may be necessary to pry the bracket into position.

Lower Bracket Tab inserted under jounce bumper strike plate that is welded to the axle.



fig. 5

3. While setting the lower bracket into position, insert the lower bracket carriage bolts into the holes in the clamp (E). Cap with two 3/8 flat washers (J) and nyloc nuts (P) and tighten both nuts evenly until tight (fig. 6).

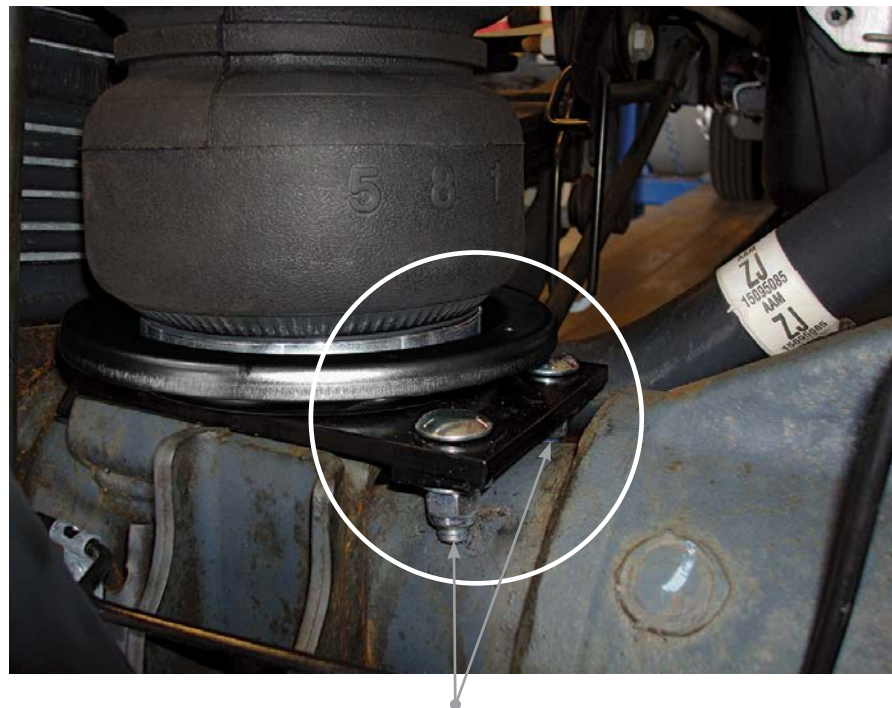

fig. 6

Carriage bolt from lower bracket through Clamp (E) and capped with Flat Washer (J) and Nyloc Nut (P). Tighten both nuts evenly until tight.

- The upper bracket will set under the bottom frame flange. Lift the axle up just far enough for the upper bracket to touch the frame.

NOTE

The upper brace also fits under the top flange of the frame (fig. 7).



fig. 7

- Using the existing holes that the jounce bumper was removed from, attach the upper bracket to the frame by using two 3/8 bolts (N) four flat washers (J) and nyloc nut (P).

NOTE

Set the nut inside, on the bracket while holding the washer onto the underside of the bolt. Push the bolt down into the nut, and then turn the bolt to get it to start. With the bellows mounting bolts still loose, it may be necessary push the bellows forward or back to gain clearance to start the nut (fig. 8).

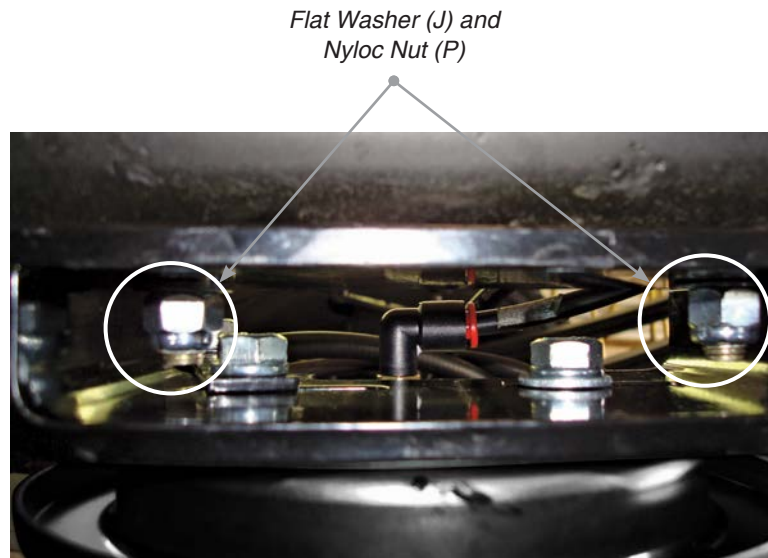

fig. 8

While holding the flat washer up on the bolt that is through the frame/bracket, set the nyloc nut in place on the bracket and slide it into position under the bolt. Push the bolt into the nyloc nut and turn the bolt to start it into the nut.

6. Align the bellows by moving the upper bracket inward or outward and by moving the bellows forward and back so that the bellows is perpendicular to both brackets. Then tighten the upper bracket mounting bolts to 31ftlbs.
7. Raise the suspension back up to stock ride height. Make sure bellows is still aligned. Push the emergency bracket (F), on the driver's side only, as far forward as possible and tighten the upper bellows mounting bolts securely. Do not over tighten.

SECURING THE EMERGENCY BRAKE CABLE

To keep the emergency brake cable from rubbing a hole in the side of the bellows, it will be necessary to secure it to the emergency brake cable mounting bracket.

1. Installing a clip (K) to the cable and attach the clip to the bracket using a 5/16 hex cap screw (L), two flat washers (O), and a nyloc nut (Q). Install the cable so it is on the bellows side of the mounting hardware (fig. 9).

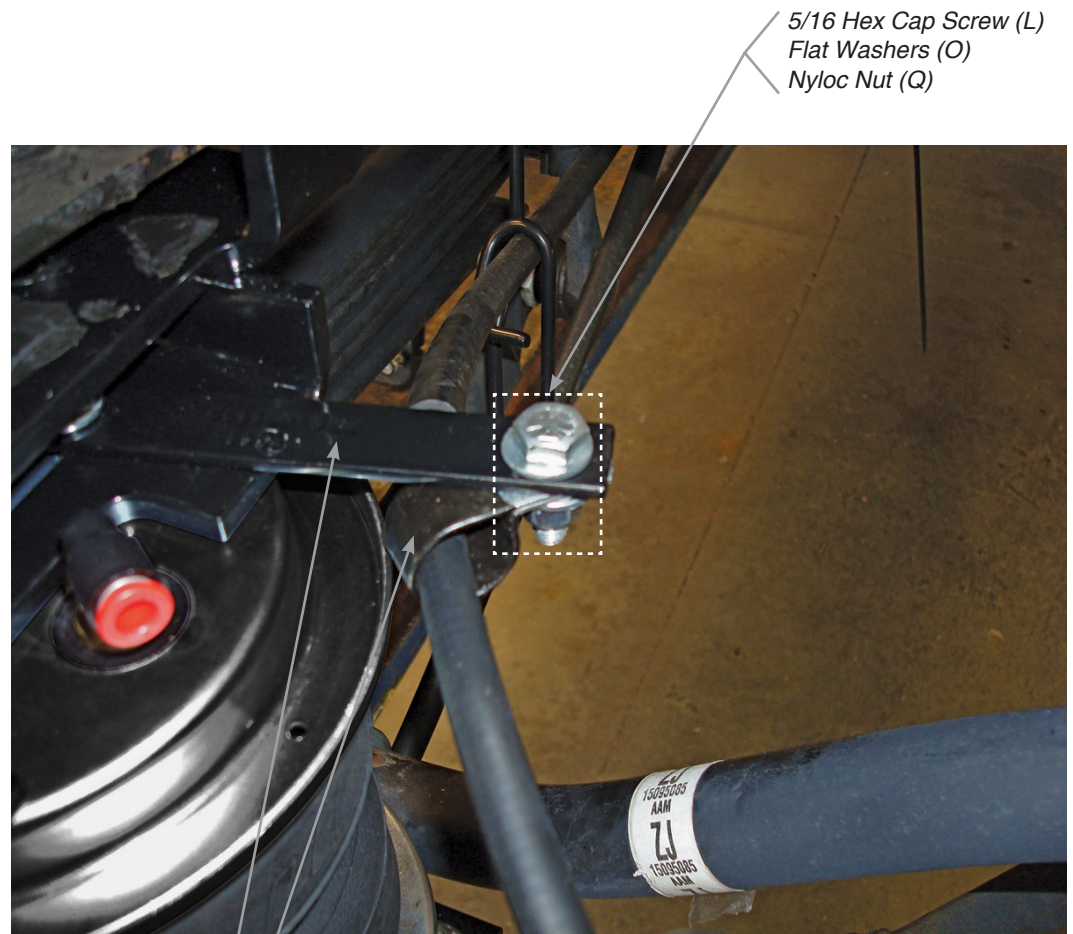

fig. 9

Emergency Brake Cable Bracket (F)

Clip (K)

Cable goes on the bellows side of the mounting hardware

INSTALLING THE AIR LINES

1. Choose a convenient location for mounting the inflation valves. Popular locations for the inflation valve are:
 - a. The wheel well flanges
 - b. The license plate recess in bumper
 - c. Under the gas cap access door
 - d. Through the license plate

NOTE

Whatever the chosen location, make sure there is enough clearance around the inflation valves for an air chuck.

2. Drill two 5/16" holes to install the inflation valves.
3. Cut the air line assembly in two equal lengths.

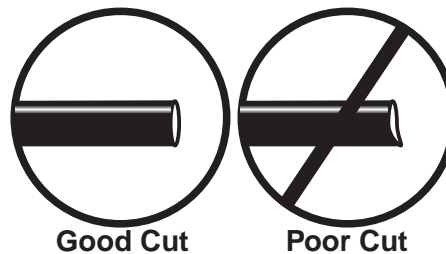

fig. 10

CAUTION

WHEN CUTTING OR TRIMMING THE AIR LINE, USE A HOSE CUTTER, A RAZOR BLADE, OR A SHARP KNIFE. A CLEAN, SQUARE CUT WILL ENSURE AGAINST LEAKS. DO NOT USE WIRE CUTTERS OR SCISSORS TO CUT THE AIR LINE. THESE TOOLS MAY FLATTEN OR CRIMP THE AIR LINE CAUSING IT TO LEAK AROUND THE O-RING SEAL INSIDE THE ELBOW FITTING (FIG. 10).

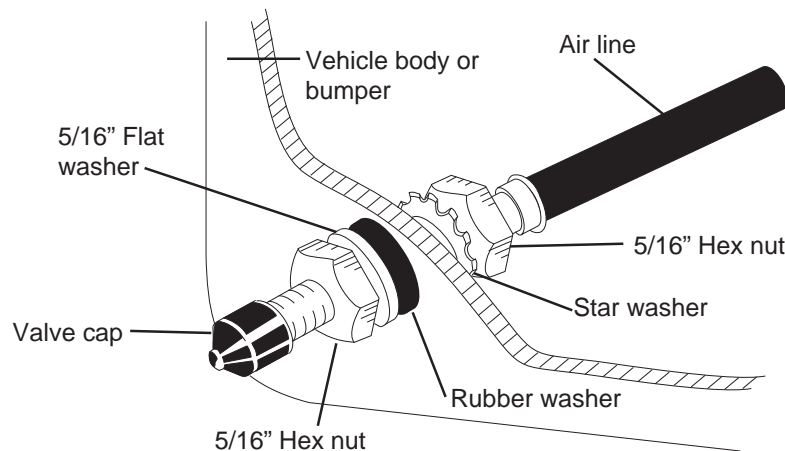

fig. 11

4. Place a 5/16" nut and star washer on the air valve. Leave enough of the inflation valve in front of the nut to extend through the hole and have room for the rubber washer, flat washer, and 5/16" nut and cap. There should be enough valve exposed after installation—approximately 1/2"—to easily apply a pressure gauge or an air chuck (fig. 11).
5. Push the inflation valve through the hole and use the rubber washer, flat washer, and another 5/16" nut to secure it in place. Tighten the nuts to secure the assembly.
6. Route the air line along the frame to the air fitting on the air spring (fig. 12). Keep AT LEAST 6" of clearance between the air line and heat sources, such as the exhaust pipes, muffler, or catalytic converter. Avoid sharp bends and edges. Use the plastic tie straps to secure the air line to fixed, non-moving points along the chassis. Be sure that the tie straps are tight, but do not pinch the air line. Leave at least 2" of slack to allow for any movement that might pull on the air line (fig. 12).

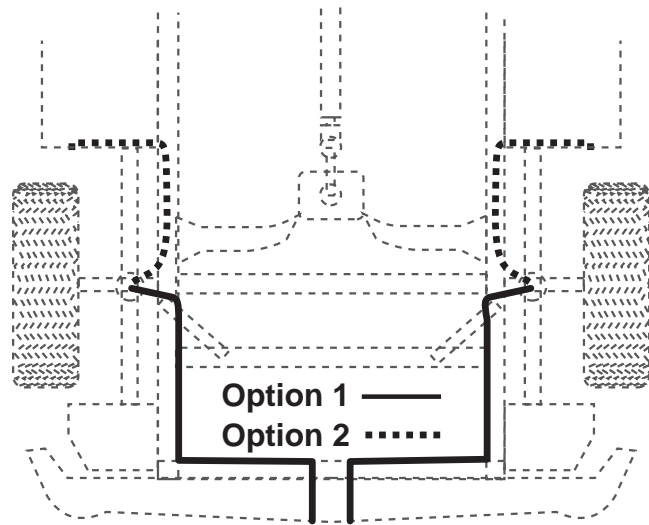

fig. 12

7. Cut off the air line, leaving approximately 12" of extra air line. A clean square cut will ensure against leaks. Insert the air line into the air fitting. This is a push-to-connect fitting. Simply push the air line into the 90° swivel fitting until it bottoms out (9/16" of air line should be in the fitting).
8. Install the minimum/maximum air pressure decal in a highly visible location. We suggest placing the decal on the driver-side window, just above the door handle.

INSTALLING THE HEAT SHIELD

1. Bend tabs to provide a 1/2" dead air space between exhaust pipe and heat shield (fig. 13).
2. Attach the heat shield to the exhaust pipe using the clamps. Bend the heat shield for maximum clearance to the air spring (fig. 13).

NOTE

If your model comes with an exhaust resonator near the installation location, you will need two 5.5" hose clamps to install the heat shield (fig. 13a).

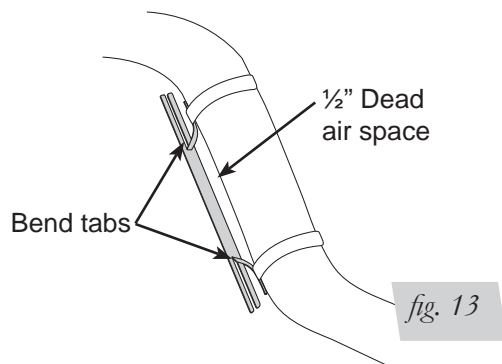

fig. 13

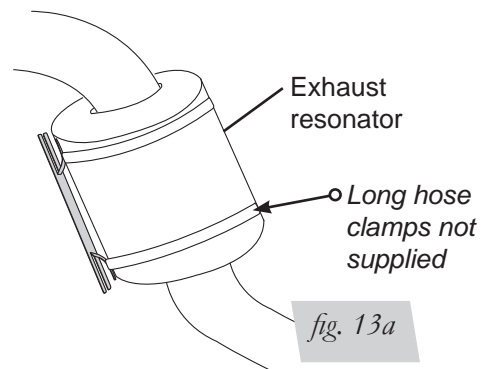

fig. 13a

CHECKING FOR LEAKS

1. Inflate the air spring to 30 PSI.
2. Spray all connections and the inflation valves with a solution of 1/5 liquid dish soap and 4/5 water. Spot leaks easily by looking for bubbles in the soapy water.
3. After the test, deflate the springs to the minimum pressure required to restore the system to normal ride height. Do not deflate to lower than 5 PSI.
4. Check the air pressure again after 24 hours. A 2 - 4 PSI loss after initial installation is normal. Retest for leaks if the loss is more than 5 lbs.

FIXING LEAKS

1. If there is a problem with the swivel fitting:
 - a. Check the air line connection by deflating the spring and removing the line by pulling the collar against the fitting and pulling firmly on the air line. Trim 1" off the end of the air line. Be sure the cut is clean and square (see fig. 10). Reinsert the air line into the push-to-connect fitting.
 - b. Check the threaded connection by tightening the swivel fitting another ½ turn. If it still leaks, deflate the air spring, remove the fitting, and re-coat the threads with thread sealant. Reinstall by hand tightening as much as possible and then use a wrench for an additional two turns.
2. If there is a problem with the inflation valve:
 - a. Check the valve core by tightening it with a valve core tool.
 - b. Check the air line by removing the air line from the barbed type fitting. Cut the air line off a few inches in front of the fitting and use a pair of pliers or vice grips to pull/twist the air line off of the fitting.

**CAUTION**

DO NOT CUT OFF THE AIR LINE COMPLETELY AS THIS WILL USUALLY NICK THE BARB AND RENDER THE FITTING USELESS.

Before Operating

INSTALLATION CHECKLIST (To be completed by installer)

- Clearance test — Inflate the air springs to 60 PSI and ensure there is at least ½” clearance around each bellow, away from anything that might rub against them. Be sure to check the tire, brake drum, frame, shock absorbers and brake cables.
- Leak test before road test — Inflate the air springs to 60 PSI, check all connections for leaks with a soapy water solution. See page 12 for tips on how to spot leaks. All leaks must be eliminated before the vehicle is road tested.
- Fastener test — Recheck all bolts for proper torque. Axle clamp bar carriage bolt lock nuts should be torqued to 16 ft/lbs. Re-torque after 100 miles.
- Road test — The vehicle should be road tested after the preceding tests. Inflate the air springs to 25 PSI (50 PSI if the vehicle is loaded). Drive the vehicle 10 miles and recheck for clearance, loose fasteners and air leaks.
- Operating instructions — If professionally installed, the installer should review the Product Use, Maintenance and Servicing section on page 14 with the owner. Be sure to provide the owner with all of the paperwork which came with the kit.

Technician’s Signature _____

Date _____

POST-INSTALLATION CHECKLIST

- Overnight leak down test — Recheck air pressure after the vehicle has been used for 24 hours. If the pressure has dropped more than 5 PSI, then there is a leak that must be fixed. Either fix the leak yourself or return to the installer for service.
- Air pressure requirements — Regardless of load, the air pressure should always be adjusted to maintain ride height at all times.
- Thirty day or 500 mile test — Recheck the air spring system after 30 days or 500 miles, whichever comes first. If any part shows signs of rubbing or abrasion, the source should be identified and moved, if possible. If it is not possible to relocate the cause of the abrasion, the air spring may need to be remounted. If professionally installed, the installer should be consulted. Check all fasteners for tightness.

Product Use, Maintenance and Servicing

Minimum Recommended Pressure	Maximum Air Pressure
5 PSI	100 PSI

MAINTENANCE GUIDELINES

NOTE

By following the steps below, vehicle owners will obtain the longest life and best results from their air springs.

1. Check the air pressure weekly.
2. Always maintain normal ride height. Never inflate beyond 100 PSI.
3. If you develop an air leak in the system, use a soapy water solution (1/5 liquid dish soap and 4/5 water) to check all air line connections and the inflation valve core before deflating and removing the air spring.

CAUTION

FOR YOUR SAFETY AND TO PREVENT POSSIBLE DAMAGE TO YOUR VEHICLE, DO NOT EXCEED MAXIMUM GROSS VEHICLE WEIGHT RATING (GVWR), AS INDICATED BY THE VEHICLE MANUFACTURER. ALTHOUGH YOUR AIR SPRINGS ARE RATED AT A MAXIMUM INFLATION PRESSURE OF 100 P.S.I., THE AIR PRESSURE ACTUALLY NEEDED IS DEPENDANT ON YOUR LOAD AND GVWR.

4. Loaded vehicles require at least 25 PSI or more. A “loaded vehicle” refers to a vehicle with a heavy bed load, a trailer, or both. As discussed above, never exceed GVWR, regardless of air spring, air pressure, or other load assist. The springs in this kit will support approximately 40 lbs. of load (combined on both springs) for each 1 PSI of pressure. The required air pressure will vary depending on the state of the original suspension. Operating the vehicle below the minimum air spring pressure will void the Air Lift warranty.
5. When increasing load, always adjust the air pressure to maintain the normal ride height. Increase or decrease pressure from the system as necessary to attain normal ride height for optimal ride and handling. Remember that loads carried behind the axle (including tongue loads) require more leveling force (pressure) than those carried directly over the axle.
6. Always add air to springs in small quantities, checking the pressure frequently.
7. Should it become necessary to raise the vehicle by the frame, make sure the system is at minimum pressure (5 PSI) to reduce the tension on the suspension/brake components. Use of on board leveling systems do not require deflation or disconnection.
8. Periodically check the air spring system fasteners for tightness. Also, check the air springs for any signs of rubbing. Realign if necessary.
9. On occasion, give the air springs a hard spray with a garden hose in order to remove mud, sand, gravel or other abrasive debris.

TROUBLESHOOTING GUIDE

1. Leak test the air line connections, the threaded connection into the air spring, and all fittings in the control system.
2. Inspect the air lines to be sure none are pinched. Tie straps may be too tight. Loosen or replace the strap and replace leaking components.
3. Inspect the air line for holes and cracks. Replace as needed.
4. Look for a kink or fold in the air line. Reroute as needed.

If the preceding steps do not solve the problem, it is possibly caused by a failed air spring — either a factory defect or an operating problem. Please call Air Lift at (800) 248-0892 for assistance.

FREQUENTLY ASKED QUESTIONS

Q. Will installing air springs increase the weight ratings of a vehicle?

No. Adding air springs will not change the weight ratings (GAWR, GCWR and/or GVWR) of a vehicle. Exceeding the GVWR is dangerous and voids the Air Lift warranty.

Q. Is it necessary to keep air in the air springs at all times and how much pressure will they need?

For LoadLifter 5000 Ultimate, the recommended minimum air pressure is 5 PSI, but it can safely be run at zero air pressure.

Q. Is it necessary to add a compressor system to the air springs?

No. Air pressure can be adjusted with any type of compressor as long as it can produce sufficient pressure to service the springs. Even a bicycle tire pump can be used, but it's a lot of work.

Q. How long should air springs last?

If the air springs are properly installed and maintained they can last indefinitely.

Q. Will raising the vehicle on a hoist for service work damage the air springs?

No. The vehicle can be lifted on a hoist for short-term service work such as tire rotation or oil changes. However, if the vehicle will be on the hoist for a prolonged period of time, support the axle with jack stands in order to take the tension off of the air springs.

TUNING THE AIR PRESSURE

Pressure determination comes down to three things — level vehicle, ride comfort, and stability.

1. Level vehicle

If the vehicle's headlights are shining into the trees or the vehicle is leaning to one side, then it is not level (fig. 2.1). Raise the air pressure to correct either of these problems and level the vehicle.

2. Ride comfort

If the vehicle has a rough or harsh ride it may be due to either too much pressure or not enough (fig. 2.2). Try different pressures to determine the best ride comfort.

3. Stability

Stability translates into safety and should be the priority, meaning the driver may need to sacrifice a perfectly level and comfortable ride. Stability issues include roll control, bounce, dive during braking and sponginess (fig. 2.3). Tuning out these problems usually requires an increase in pressure.



Bad headlight aim *fig. 2.1*



Rough ride *fig. 2.2*



Sway and body roll *fig. 2.3*

GUIDELINES FOR ADDING AIR

1. Start with the vehicle level or slightly above.
2. When in doubt, always add air.
3. If the front of the vehicle dives while braking, increase the pressure in the front air bags, if equipped.
4. If it is ever suspected that the air bags have bottomed out, increase the pressure (fig. 2.4).
5. Adjust the pressure up and down to find the best ride.
6. If the vehicle rocks and rolls, adjust the air pressure to reduce movement.
7. It may be necessary to maintain different pressures on each side of the vehicle. Loads such as water, fuel, and appliances will cause the vehicle to be heavier on one side (fig. 2.5). As much as a 50 PSI difference is not uncommon.



Bottoming out

fig. 2.4

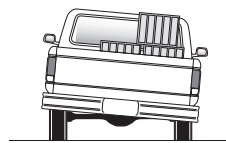

Unlevel

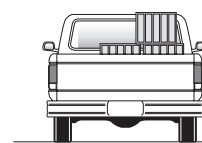

Level

fig. 2.5

Choosing the Right On-Board Air Compressor System

60 DAY NO QUESTIONS ASKED, MONEY-BACK GUARANTEE

TWO YEAR COMPRESSOR SYSTEM WARRANTY

Add an on-board air compressor system to inflate and deflate your air springs with the touch of a button — from inside or outside of the vehicle.

- For convenient, on-the-go control of your air springs, add an Air Lift on-board air compressor system.
- Air Lift on-board air compressor systems eliminate the search for gas stations that have a working compressor, saving you time, energy and money.
- All systems include a compressor, controller and all parts needed for easy installation.

1. Choose single or dual path inflation (see illustrations at right)

2. Choose wireless or analog control

- **Wireless:** Control your air springs from inside or outside the vehicle. Easiest installation - no wires to the cab.
- **Analog:** In-cab control of your air springs. Economically priced.

3. Choose heavy or standard duty compressor

- **Standard duty:** A standard duty compressor will work well for most customers who use their system on an intermittent basis.
- **Heavy duty:** For daily use, consider the heavy duty compressor - it inflates faster and more quietly than the standard compressor.

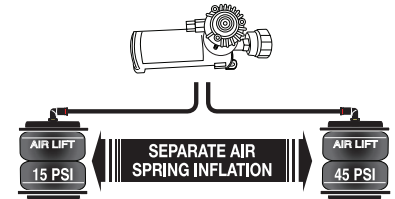

Dual path systems Air springs are controlled separately to allow for different air pressure from side-to-side. Perfect for uneven or top-heavy loads.

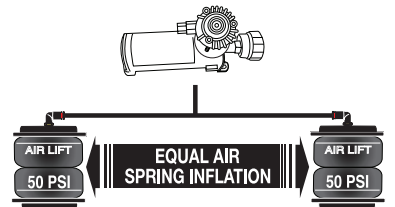

Single path systems Two springs will inflate at the same time. Good for loads that are evenly distributed from left-to-right or front-to-back.

WIRELESS

ANALOG

DUAL PATH

WirelessAIR™

OUR PREMIUM SYSTEM!

- Easy installation
- Includes heavy duty compressor



P/N 72000

LoadCONTROLLER™

Dual

Compact, economically priced control.



P/N Standard Duty Compressor 25850; P/N Heavy Duty Compressor 25854

SINGLE PATH

WirelessONE™

- Easy installation
- Includes standard duty compressor



P/N 25870

LoadCONTROLLER™

Single

Compact, economically priced control.



P/N Standard Duty Compressor 25852; P/N Heavy Duty Compressor 25856