

AIRLIFT 1000

BY
AIRLIFT

MN-285
(02706)
ECN2200

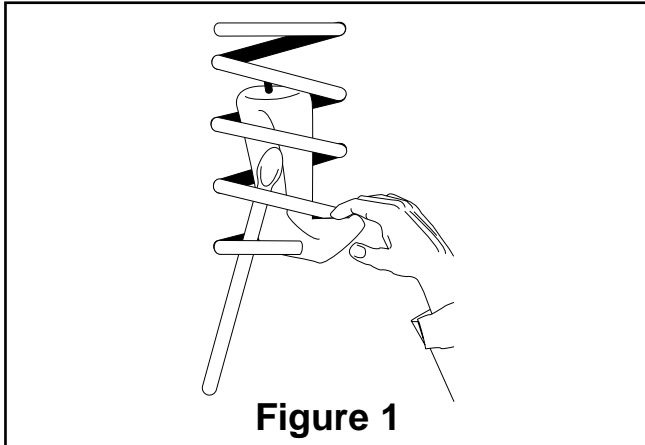

Figure 1

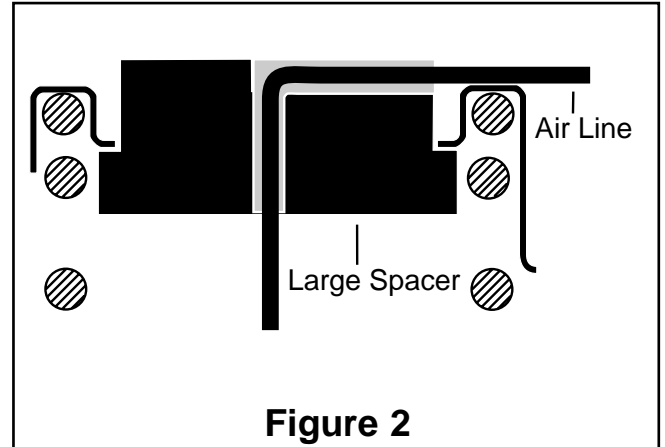

Figure 2

1. Jack up rear of vehicle or raise on hoist. Support frame with safety stands. Remove lower shock absorber attaching bolts.
2. Carefully lower axle or raise body of vehicle until suspension is fully extended. **CAUTION: Observe tension on brake line-Do Not Strain.** The coil springs must be removed from the upper spring seat for this installation:
 - a. Detach the shock absorbers at the lower shock mount.
 - b. Carefully lower the axle until the coil springs are free from the upper spring seat. **Do not strain brake lines.**
3. Insert the lower protector in the bottom of the coil spring (Figure 3). Position the holes of the protector over the bolt heads in the lower spring seat.
4. Insert the air cylinder into the coil with the valve stem at the top (Figure 1).
5. Cut the air line in equal lengths and slide on air line clamp over one end. Push the air line onto the stem of air cylinder, covering all the barbs. With pliers slide the air line clamp downward until it fully covers the barbed section (Figure 5).
6. Insert large spacer into the coil. Route the air line through the hole in the spacer and push spacer into the hole in the upper spring seat (Figure 2). Route airline horizontally through groove in the spacer. Repeat this process for the other side.
7. Carefully raise the axle to seat the coil springs in the upper spring seats.
9. Reconnect the shock absorbers.
10. Install the heat shield. Separate instructions are included with the heat shield.

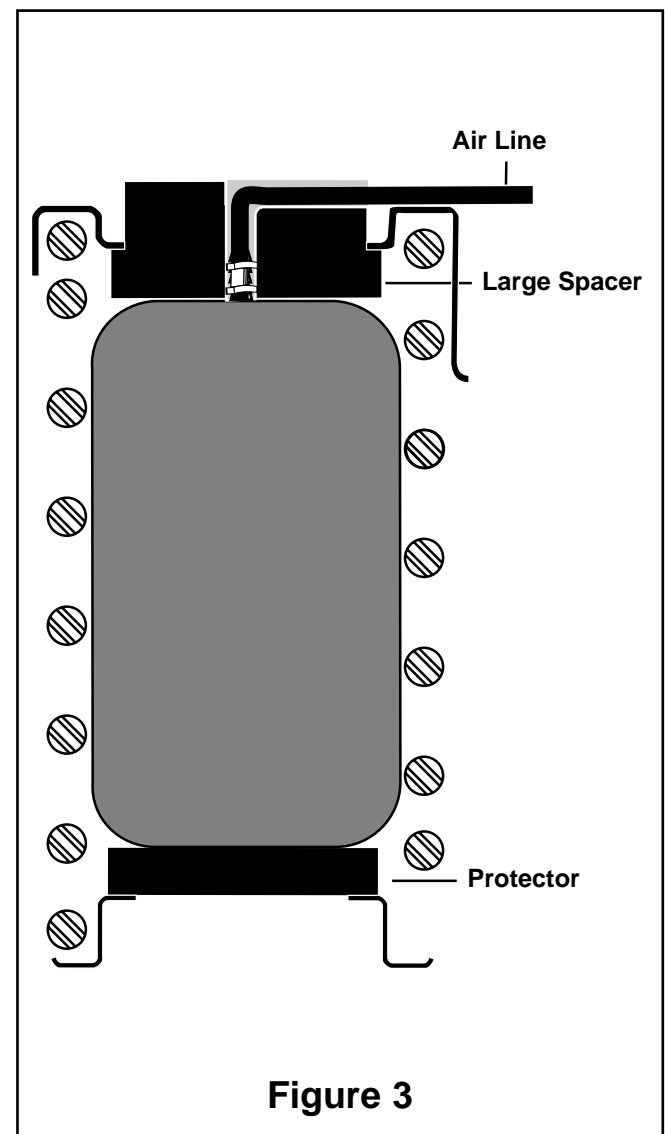
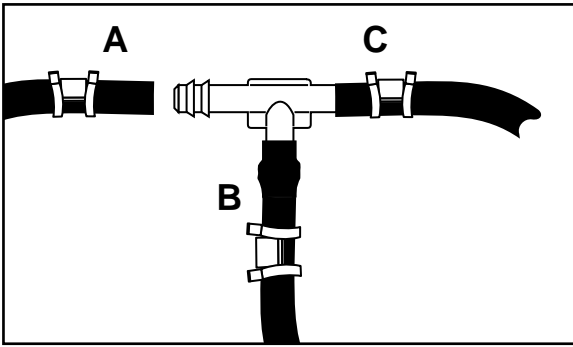

Figure 3



Use this procedure for all air line connections:
A. Slide air line clamp onto the air line
B. Push the air line over the barbed stem.
C. Compress the ears on the air line clamp with pliers and slide it forward to fully cover the barbed section.

Figure 4

DO NOT INFLATE AIR CYLINDERS BEFORE READING MAINTENANCE/OPERATION TIPS. SEE PAGE 4 FOR INFLATION PROCEDURES.

Tee air line installation recommended unless weight in vehicle varies from one side to the other and unequal pressures are needed to level the load. Dual air lines are used in this case.

TEE AIR LINE ROUTING

TO PREVENT AIR LINE FROM MELTING, KEEP IT AT LEAST EIGHT INCHES FROM EXHAUST SYSTEM.

- A. Locate desired tee location on the frame rail or cross member.
- B. Route along cross member from the upper spring seat to tee location. Attach with provided plastic straps.

CAUTION: LEAVE SUFFICIENT AIR LINE SLACK TO PREVENT ANY STRAIN ON FITTING DURING AXLE MOTIONS.

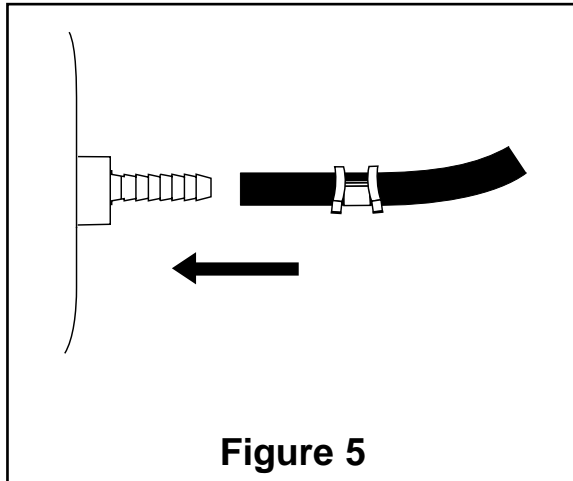

Figure 5

- C. Cut off excess air line and slide air line clamp onto the air line. Push the air line over one side of the tee until all the barbs are covered. Repeat procedure for other leg of tee.

- D. With pliers slide the air line clamp forward until it fully covers the barbed section. Repeat for the air line from the other air cylinder (Figure 4).

- E. Select a location for inflation valve in the gas cap well, the trunk, rear bumper, fender flange or behind the license plate, assuring that the valve will be protected and accessible with an air hose (Figure 6).

- F. Drill a 5/16" hole for inflation valve and mount as in illustration (Figure 8). Rubber washer is for outside weather seal.

- G. Push the remaining air line over the last fitting on tee and route along frame to desired inflation valve location (Figure 6). Attach with plastic straps or wire.

- H. Slide air line clamp over the air line. Push air line onto fitting covering all barbs, with pliers slide the air line clamp forward until it fully covers the barbed section (Figure 7).

- I. Raise axle or lower body until air cylinders lightly touch lower spring protector and upper spacer. **NOTE-Check to be sure the air line does not kink or become pinched between the spacer and cylinder or floor pan.**

- J. Continue with step 13.

DUAL AIR LINE ROUTING

TO PREVENT AIR LINE FROM MELTING, KEEP IT AT LEAST EIGHT INCHES FROM EXHAUST SYSTEM.

- A. Select a location for the inflation valves in the rocker panel flange, or rear bumper, assuring that each valve will be protected and accessible with an air hose (Figure 9).

- B. Drill 5/16" hole for inflation valves and mount as illustrated. Rubber washer is for outside weather seal (Figure 8).

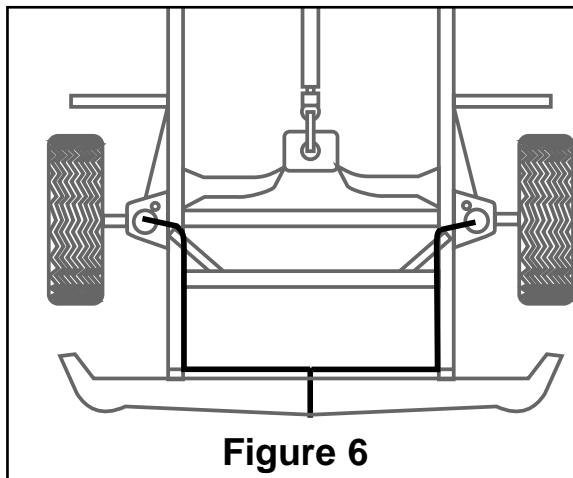
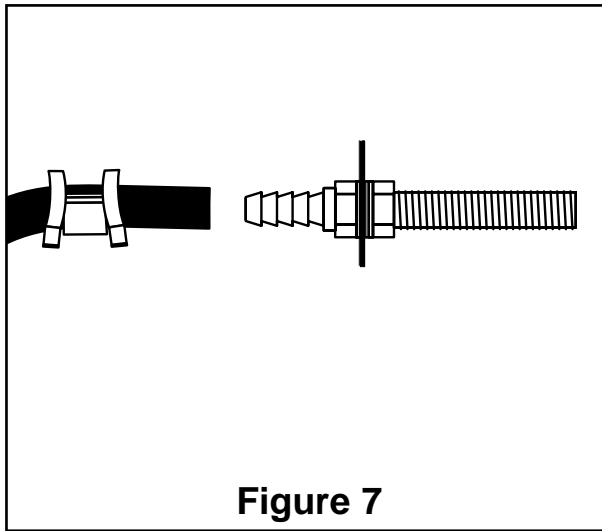

Figure 6



C. Route air line along control arm and frame to inflation valve location and cut off excess air line. Attach with plastic straps or wire.

CAUTION: LEAVE SUFFICIENT AIR LINE SLACK TO PREVENT ANY STRAIN ON VALVE STEM DURING NORMAL AXLE MOTIONS.

D. Slide air line clamp onto the air line and push the air line over the fitting, covering all the barbs. With pliers slide the air line clamp forward until it fully covers the barbed section.

E. Repeat process for the other side.

F. Raise axle or lower body until air cylinders lightly touch lower spring protector and upper spacer. **NOTE-Check to be sure the air line does not kink or become pinched between the spacer and cylinder or floor board.**

G. Continue with step 13.

DO NOT INFLATE AIR CYLINDERS BEFORE READING MAINTENANCE/OPERATION TIPS.

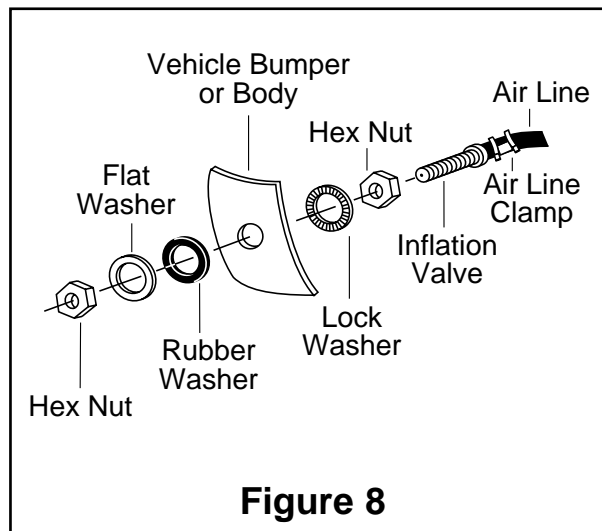

13. Inflate Air Springs to 35 p.s.i. Check for air leaks at all fittings and valve core with a soapy water solution.

14. Replace wheels, remove safety stands and carefully lower vehicle to ground.

15. Deflate Air Springs in 5 p.s.i. intervals to determine best ride and handing. Sufficient air pressure should be maintained to help prevent bottoming-out on large bumps, chuck holes, etc

16. Recheck air pressure after 24 hours. A 2-4 p.s.i. loss is normal after initial installation. If the pressure has dropped more than 5 p.s.i. re-test for leaks with a soapy water solution. Please read and follow the Maintenance and Operation Tips on page 4.

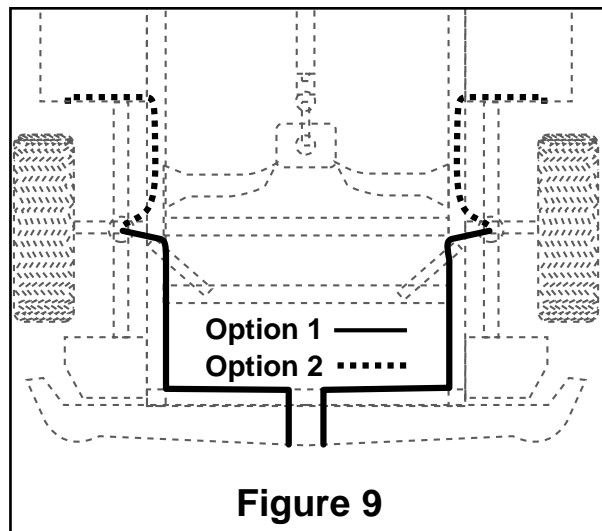



Product Use Information

Frequently asked questions

Q. Will installing air springs increase the weight ratings of a vehicle?

No. Adding air springs will not change the weight ratings (GAWR, GCWR and/or GVWR) of a vehicle. Exceeding the GVWR is dangerous and voids the Air Lift warranty.

Q. Is it necessary to keep air in the air springs at all time and how much pressure will they need?

The minimum air pressure should be maintained at all times. The minimum air pressure keeps the air spring in shape, ensuring that it will move throughout its travel without rubbing or wearing on itself.

Q. Is it necessary to add a compressor system to the air springs?

No. Air pressure can be adjusted with any type of compressor as long as it can produce sufficient pressure to service the springs. Even a bicycle tire pump can be used, but it's a lot of work.

Q. How long should air springs last?

If the air springs are properly installed and maintained they can last indefinitely.

Q. Will raising the vehicle on a hoist for service work damage the air springs?

No. The vehicle can be lifted on a hoist for short-term service work such as tire rotation or oil changes. However, if the vehicle will be on the hoist for a prolonged period of time, support the axle with jack stands in order to take the tension off of the air springs.

Tuning the air pressure

Pressure determination comes down to three things — level vehicle, ride comfort, and stability.

1. Level vehicle

If the vehicle's headlights are shining into the trees or the vehicle is leaning to one side, then it is not level (fig. 1). Raise the air pressure to correct either of these problems and level the vehicle.

2. Ride comfort

If the vehicle has a rough and harsh ride it may be due to either too much pressure or not enough (fig. 2). Try different pressures to determine the best ride comfort.

3. Stability

Stability translates into safety and should be the priority, meaning the driver may need to sacrifice a perfectly level and comfortable ride. Stability issues include roll control, bounce, dive during braking and sponginess (fig. 3). Tuning out these problems usually requires an increase in pressure.

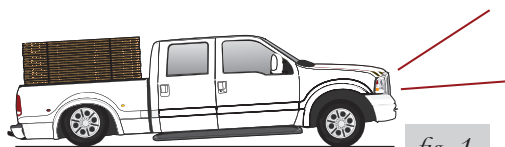

Bad headlight aim



Sway and body roll



Rough ride

Guidelines for adding air:

1. Start with the vehicle level or slightly above.
2. When in doubt, always add air.
3. For motorhomes, start with 50-100 PSI in the rear because it can be safely assumed that it is heavily loaded.
4. If the front of the vehicle dives while braking, increase the pressure in the front air bags, if equipped.
5. If it is ever suspected that the air bags have bottomed out, increase the pressure (fig. 4).
6. Adjust the pressure up and down to find the best ride.
7. If the vehicle rocks and rolls, adjust the air pressure to reduce movement.
8. It may be necessary to maintain different pressures on each side of the vehicle. Loads such as water, fuel, and appliances will cause the vehicle to be heavier on one side (fig. 5). As much as a 50 PSI difference is not uncommon.

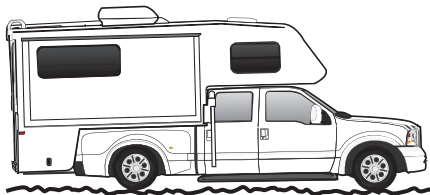

Bottoming out

fig. 4

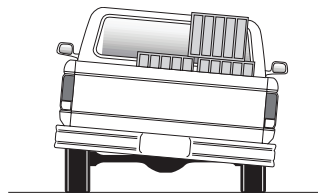

Unlevel

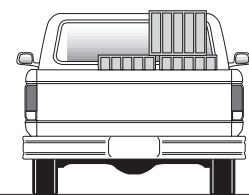

Level

fig. 5