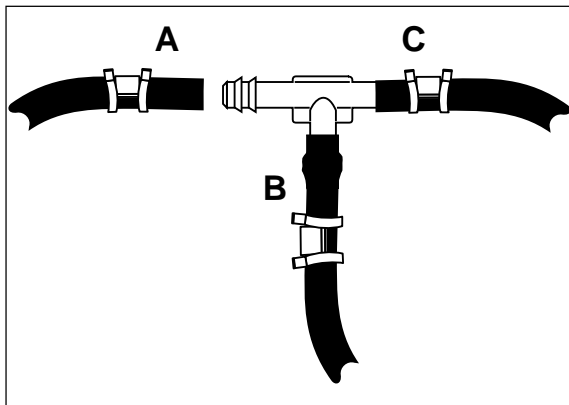

Figure 1



Use this procedure for all line connections:

- A. Slide air line clamp onto the air line
- B. Push the air line over the barbed stem.
- C. Compress the ears on the air line clamp with pliers and slide it forward to fully cover the barbed section.

Figure 2

I. Preparing the Vehicle

1. Jack up rear of vehicle or raise on hoist. Support frame with safety stands.
2. Mark the top of the coil springs and coil spring mount with a marker. This will help index the coil spring so it can be put back into the same location it was removed from.
3. The lower shock mounts and panhard rod will have to be disconnected in order to remove the coil springs. Lower the axle or raise the body of the vehicle until the coil spring can be removed.

CAUTION: Observe the tension on the brake-line. Do not strain.

4. Remove the coil springs and enlarge the small hole in the bottom spring seat to 3/4" for hose and valve stem clearance.
5. Insert the non-stem end of the cylinder into the bottom of the coil and push the cylinder to the top of the coil. Install the coil spring back into the mounts indexing them using the previously made marks.
6. Re-attach the panhard rod and shock mounts (Figure 1).

Tighten the mounting hardware securely.

NOTE: Before raising the axle, attach the air lines.

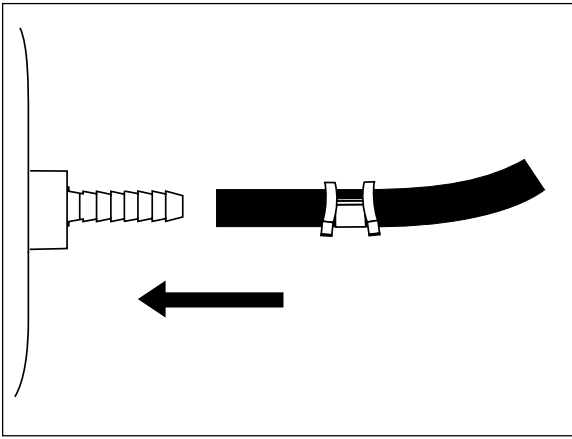

Figure 3

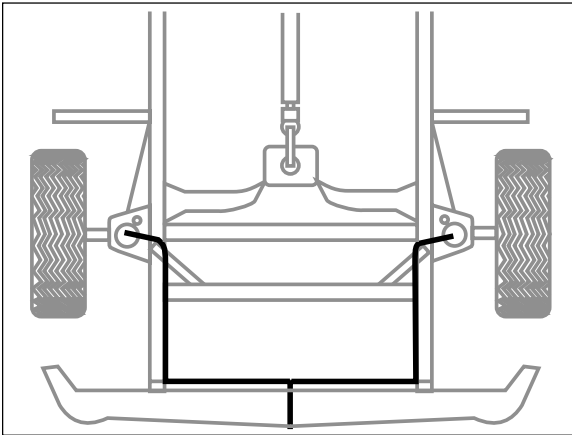

Figure 4

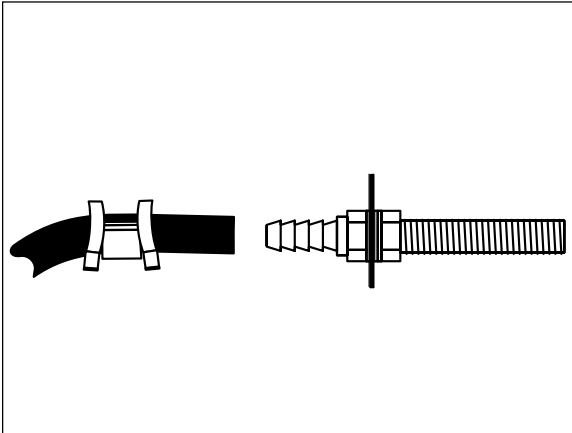

Figure 5

II. Tee Air Line Routing

Tee air line installation is recommended unless the weight in the vehicle varies from one side to the other and unequal pressures are needed to level the load. Dual air lines are used in this case.

TO PREVENT AIR LINE FROM MELTING, KEEP IT AT LEAST EIGHT INCHES FROM EXHAUST SYSTEM.

1. Locate desired tee location on the frame rail or cross member.
2. Determine and cut adequate length of air line to reach from tee to left and right side on air cylinders.

CAUTION: LEAVE SUFFICIENT AIR LINE SLACK TO PREVENT ANY STRAIN ON FITTING DURING AXLE MOTIONS.

3. Slide air line clamp onto the air line.
4. Push the air line over one side of the tee until all the barbs are covered. Repeat procedure for other leg of tee (Figure 2).
5. With pliers slide the air line clamp forward until it fully covers the barbed section. Repeat for other leg of tee (Figure 2).
6. Route along cross member and either lower control arm or upper spring seat to air cylinder.
7. Insert air line through spring seat.
8. Push the air line onto the stem, covering all the barbs (Figure 3).
9. With pliers slide the air line clamp upward until it fully covers the barbed section.
10. Push the remaining air line over the last fitting on tee and route along frame to desired inflation valve location (Figure 4). Attach with plastic straps or wire.

11. Select a location for inflation valve in the gas cap well, the truck, rear bumper, fender flange or behind the license plate, insuring that the valve will be protected and accessible with an air hose.

12. Drill a 5/16" hole for inflation valve and mount as in illustration (Figure 6). Rubber washer is for outside weather seal.

13. Slide air line clamp over the air line. Push air line onto fitting covering all barbs, with pliers slide the air line clamp forward until it fully covers the barbed section (Figure 5).

14. Raise axle or lower body until air cylinders lightly touch upper spring seat and lower spacers.

15. Check TAILPIPE clearance and insure that it is at least 2-3 inches from air cylinder. If necessary, loosen clamps and rotate or move to obtain additional clearance.

If heat shield is provided, install it. Attach shock absorbers if removed earlier in the installation.

DO NOT INFLATE AIR CYLINDERS BEFORE READING INFLATION PROCEDURES.

16. Continue with inflation procedures in step IV.

II. Dual Air Line Routing

TO PREVENT AIR LINE FROM MELTING, KEEP IT AT LEAST EIGHT INCHES FROM EXHAUST SYSTEM.

1. Select a location for the inflation valves in the rocker panel flange, or rear bumper, assuring that each valve will be protected and accessible with an air hose (Figure 7).
2. Determine and cut adequate length of air line to reach from valve location to left side air cylinder.

CAUTION: LEAVE SUFFICIENT AIR LINE SLACK TO PREVENT ANY STRAIN ON VALVE STEM DURING NORMAL AXLE MOTIONS.

3. Insert the air line through the spring sea.
4. Slide air line clamp onto the cut air line.
5. Push the air line onto the stem, covering all the barbed section (Figure 3).
6. With pliers slide the air line clamp forward until it fully covers barbed section (Figure 3).
7. Repeat process for right side.
8. Drill 5/16" hole for inflating valves and mount as illustrated. Rubber washer is for outside weather seal (Figure 6).

9. Route air line along control arm and frame to inflation valve location and cut off excess.
10. Slide a clamp onto the air line and push the air line over the fitting, covering all the barbs.
11. With pliers slide the air line clamp forward until it fully covers the barbed section.
12. Raise axle or lower body until air cylinders lightly touch upper spring seat and lower spacers.

13. Check TAILPIPE clearance and insure that it is at least 2-3 inches from air cylinders, If necessary, loosen clamps and rotate or move to obtain additional clearance. If heat shields are supplied, install them.

Attach shock absorbers if removed earlier in the installation.

DO NOT INFLATE AIR CYLINDERS BEFORE READING INFLATION PROCEDURES.

14. Continue with inflation procedures step IV.

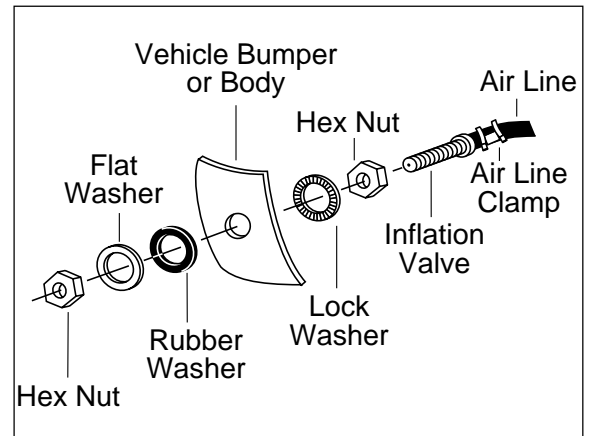

Figure 6

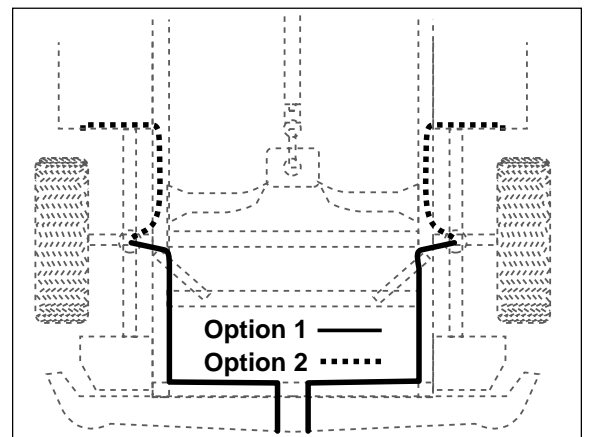

Figure 7

IV. Inflation Procedures

INFLATION PROCEDURES:

- 1. Inflate your air springs to 30 p.s.i. before adding the payload. After vehicle is loaded, adjust your air pressure to level the vehicle and for ride comfort.*
- 2. When you are carrying a payload it will be helpful to increase the tire inflation pressure in proportion to any over load condition. We recommend a 2 p.s.i. increase above normal (not to exceed tire manufacturers maximum) for each 100 lbs. additional load on the axle.*

Maintenance and Operations

MINIMUM AIR PRESSURE	MAXIMUM AIR PRESSURE
5 psi	35 psi

By following these steps, vehicle owners should obtain the longest life and best results from their air springs.

Maintenance Tips:

1. Check the air pressure in the air springs weekly.
2. Always maintain at least the 5 p.s.i. air pressure to prevent chafing or coil pinch.
3. If you develop a leak in the system, use a soapy/water solution to check all air line connections and the valve core before removing the cylinder.

Operating Tips:

1. Inflate your air springs to 35 p.s.i. before adding the payload. This will allow the air cylinder to properly mesh with the coil spring. After vehicle is loaded, adjust your air pressure (down) to level the vehicle and for ride comfort.
2. When you are carrying a payload it will be helpful to increase the tire inflation pressure in proportion to any overload condition. We recommend a 2 p.s.i. increase above normal (not to exceed tire manufacturers maximum) for each 100 lbs. additional load on the axle.

CAUTION: *Do not exceed the vehicle manufacturers maximum gross vehicle weight rating.*

CAUTION: *Failure to maintain minimum pressure will void the warranty.*



Product Use Information

Frequently asked questions

Q. Will installing air springs increase the weight ratings of a vehicle?

No. Adding air springs will not change the weight ratings (GAWR, GCWR and/or GVWR) of a vehicle. Exceeding the GVWR is dangerous and voids the Air Lift warranty.

Q. Is it necessary to keep air in the air springs at all time and how much pressure will they need?

The minimum air pressure should be maintained at all times. The minimum air pressure keeps the air spring in shape, ensuring that it will move throughout its travel without rubbing or wearing on itself.

Q. Is it necessary to add a compressor system to the air springs?

No. Air pressure can be adjusted with any type of compressor as long as it can produce sufficient pressure to service the springs. Even a bicycle tire pump can be used, but it's a lot of work.

Q. How long should air springs last?

If the air springs are properly installed and maintained they can last indefinitely.

Q. Will raising the vehicle on a hoist for service work damage the air springs?

No. The vehicle can be lifted on a hoist for short-term service work such as tire rotation or oil changes. However, if the vehicle will be on the hoist for a prolonged period of time, support the axle with jack stands in order to take the tension off of the air springs.

Tuning the air pressure

Pressure determination comes down to three things — level vehicle, ride comfort, and stability.

1. Level vehicle

If the vehicle's headlights are shining into the trees or the vehicle is leaning to one side, then it is not level (fig. 1). Raise the air pressure to correct either of these problems and level the vehicle.

2. Ride comfort

If the vehicle has a rough and harsh ride it may be due to either too much pressure or not enough (fig. 2). Try different pressures to determine the best ride comfort.

3. Stability

Stability translates into safety and should be the priority, meaning the driver may need to sacrifice a perfectly level and comfortable ride. Stability issues include roll control, bounce, dive during braking and sponginess (fig. 3). Tuning out these problems usually requires an increase in pressure.

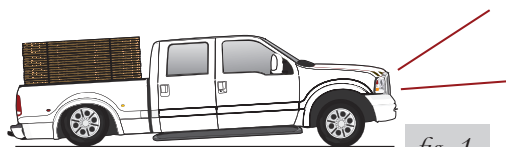

Bad headlight aim

fig. 1



Sway and body roll

fig. 2

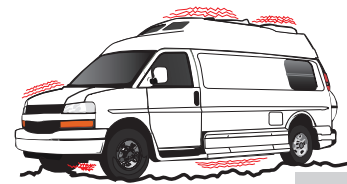

Rough ride

fig. 3

Guidelines for adding air:

1. Start with the vehicle level or slightly above.
2. When in doubt, always add air.
3. For motorhomes, start with 50-100 PSI in the rear because it can be safely assumed that it is heavily loaded.
4. If the front of the vehicle dives while braking, increase the pressure in the front air bags, if equipped.
5. If it is ever suspected that the air bags have bottomed out, increase the pressure (fig. 4).
6. Adjust the pressure up and down to find the best ride.
7. If the vehicle rocks and rolls, adjust the air pressure to reduce movement.
8. It may be necessary to maintain different pressures on each side of the vehicle. Loads such as water, fuel, and appliances will cause the vehicle to be heavier on one side (fig. 5). As much as a 50 PSI difference is not uncommon.

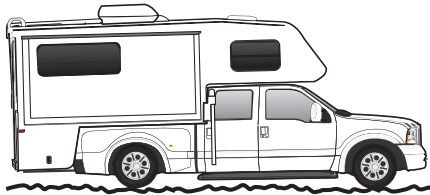

Bottoming out

fig. 4

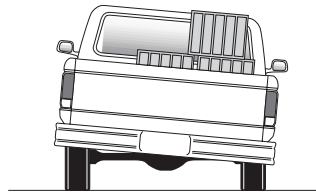

Unlevel

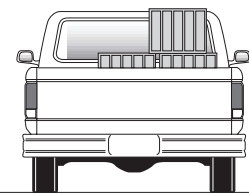

Level

fig. 5