

## Kit Numbers 60799 & 60702

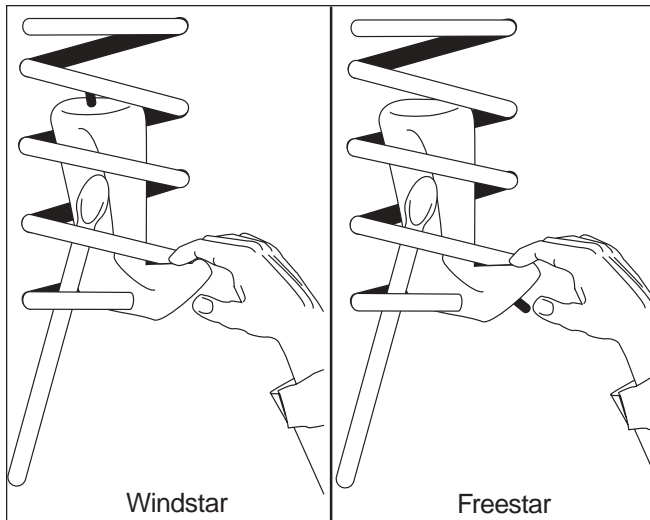

Figure 1

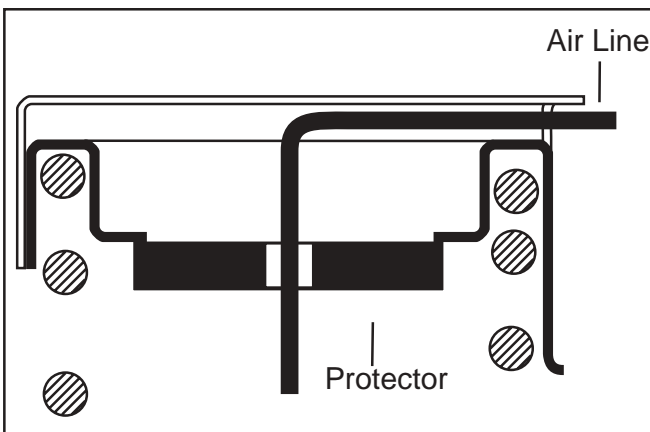

Figure 2

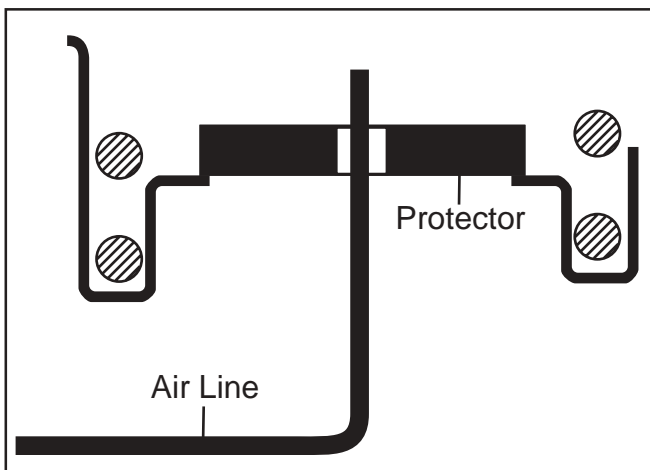

Figure 3

1. Lower or raise the body of the vehicle until the suspension is fully extended. Support the frame with jack stands.
2. Air cylinders are shipped in the "as molded" shape. For ease of installation, remove the plastic cap from the barbed stem on the end of the cylinder. Push on the air cylinder to evacuate as much air as possible. The air bag may be rolled up toward the valve stem. Replace the cap on the stem to maintain the flattened shape.

### 3. **For Ford Windstars:**

Insert the flattened air cylinder into the lowest opening with the stem at the top. Push the cylinder up within the coil by hand or with a blunt instrument such as a spoon-type tire iron (Figure 1).

### **For Ford Freestars:**

Insert the flattened air cylinder into the lowest opening with the stem at the base of the cylinder. Push the cylinder up within the coil by hand or with a blunt instrument such as a spoon-type tire iron (Figure 1).

4. When the cylinder is completely within the coil, remove the cap and allow the cylinder to assume its "as molded" shape.
5. **For Ford Windstars:**

Install the protector in the upper spring seat as shown in Figure 2.

### **For Ford Freestars:**

Install the protector in the lower spring seat as shown in Figure 3.

6. Install the air line as detailed on pages 2 and 3.
7. Inflate the cylinders to 35 lbs. air pressure. Test for air leaks by applying a liquid soap solution to all valve cores, fittings, and connections.
8. Lower the vehicle to the ground and adjust the air pressure until the vehicle is at the desired ride height. Read the Maintenance/Operation section for proper care of your air cylinders.
9. Recheck air pressure after 24 hours. A 2-4 p.s.i. loss after initial installation is normal. If pressure has dropped more than 5 p.s.i. retest for leaks with a soapy water solution.

**DO NOT INFLATE AIR CYLINDERS BEFORE READING THE MAINTENANCE/OPERATION SECTION ON THE LAST PAGE.**

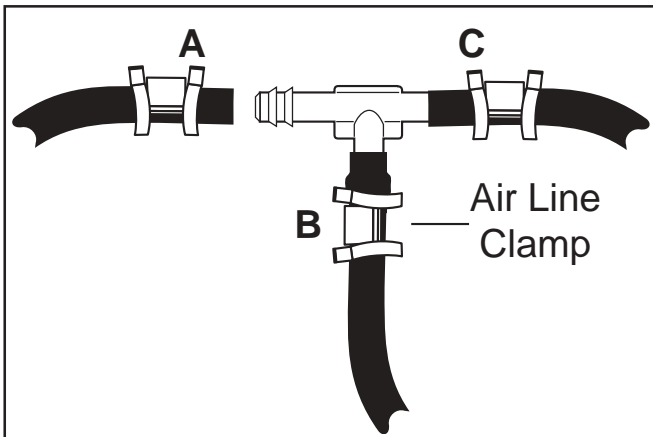

Use this procedure for all line connections:

- A. Slide air line clamp onto the air line
- B. Push the air line over the barbed stem.
- C. Compress the ears on the air line clamp with pliers and slide it forward to fully cover the barbed section.

Figure 4

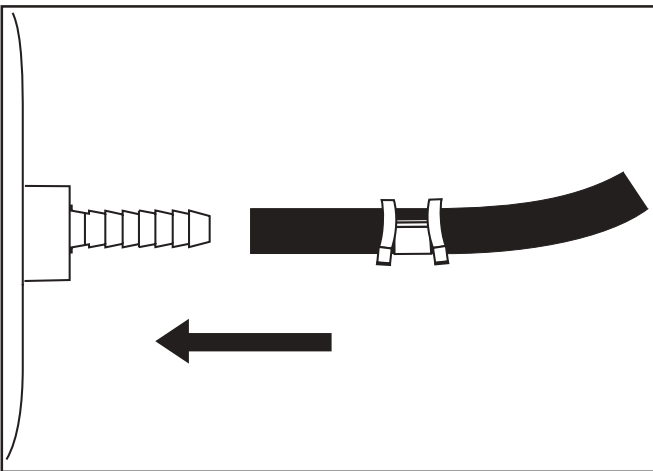

Figure 5

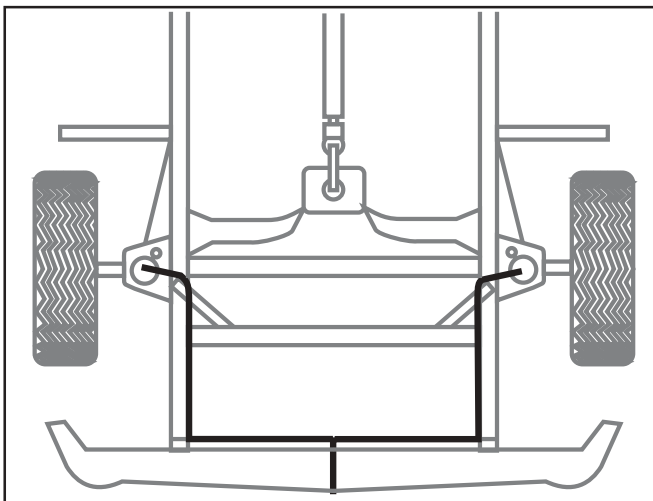

Figure 6

## Air Line Instructions

**CAUTION: LEAVE SUFFICIENT AIR LINE SLACK TO PREVENT ANY STRAIN ON FITTINGS DURING AXLE MOTIONS.**

**TO PREVENT AIR LINE FROM MELTING, KEEP IT AT LEAST TWELVE INCHES FROM THE EXHAUST SYSTEM.**

*Note: "T" air line installation is recommended unless weight in vehicle varies from one side to the other and unequal pressures are needed to level the load. Dual air lines are used in this case.*

1. Locate desired tee location on the frame rail or cross member.
2. Determine and cut adequate length of air line to reach from tee to left and right side on air cylinders.

**CAUTION: LEAVE SUFFICIENT AIR LINE SLACK TO PREVENT ANY STRAIN ON FITTING DURING AXLE MOTIONS.**

*To prevent air line from melting, keep it at least twelve inches from the exhaust system.*

3. Slide air line clamp onto the air line.
4. Push the air line over one side of the tee until all the barbs are covered. Repeat procedure for other leg of tee (Figure 4).
5. With pliers, slide the air line clamp forward until it fully covers the barbed section. Repeat for other leg of tee (Figure 4).
6. Route air line along cross member and upper spring seat to left and right air cylinder.
7. Insert air line through spring seat protector and slide on the air line clamp (Figure 5).
8. Push the air line onto the barbed cylinder stem, covering all the barbs (Figure 5).
9. With pliers, slide the air line clamp upward until it fully covers the barbed section.
10. Push the remaining air line over the last fitting on tee and route along frame to desired inflation valve location (Figure 6). Attach with plastic straps or wire.
11. Select a location for inflation valve in the gas cap well, the trunk, rear bumper, fender flange or behind the license plate. Insure that the valve will be protected and accessible with an air hose.

12. Drill a 5/16" hole for inflation valve and mount as illustrated in Figure 8. The rubber washer is for outside weather seal.
13. Slide air line clamp over the air line. Push air line onto fitting covering all barbs. With pliers slide the air line clamp forward until it fully covers the barbed section (Figure 4).
14. Continue with step 7 on page 1.

## II. Dual Air Line Routing

*NOTE: To prevent air line from melting, keep it at least eight inches from exhaust system.*

1. Select a location for the inflation valves in the gas cap well, the trunk, rear bumper, fender flange or behind the license plate. Insure that each valve will be protected and accessible with an air line.
2. Determine and cut an adequate length of air line to reach from the valve location to the left side air cylinder.

*NOTE: Do not cut the air line longer that 90".*

*CAUTION: LEAVE SUFFICIENT AIR LINE SLACK TO PREVENT ANY STRAIN ON VALVE STEM DURING NORMAL AXLE MOTIONS.*

3. Insert the air line through the spring seat protector and slide on the air line clamp (Figure 4).
4. Push the air line onto the barbed cylinder stem, covering all the barbs (Figure 5).
6. With pliers, slide the air line clamp forward until it fully covers the barbed section.
7. Route the air line along the frame or under the fender panel to the desired inflation valve location (Figure 9). Attach the air line to the chassis with plastic straps or wire.
8. Drill 5/16" hole for inflating valves and mount as illustrated. The rubber washer is for outside weather seal (Figure 8).
9. Slide air clamp over the air line. Push the air line over the fitting, covering all the barbs.
11. With pliers slide the air line clamp forward until it fully covers the barbed section.

12. Repeat the process for the right side.

14. Continue with step 7 on page 1.

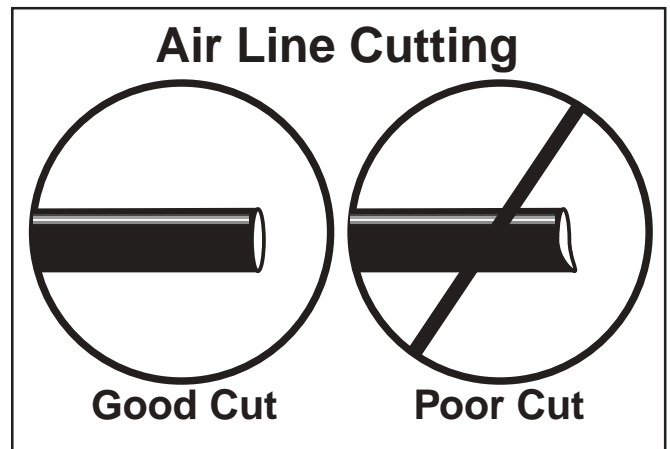

Figure 7

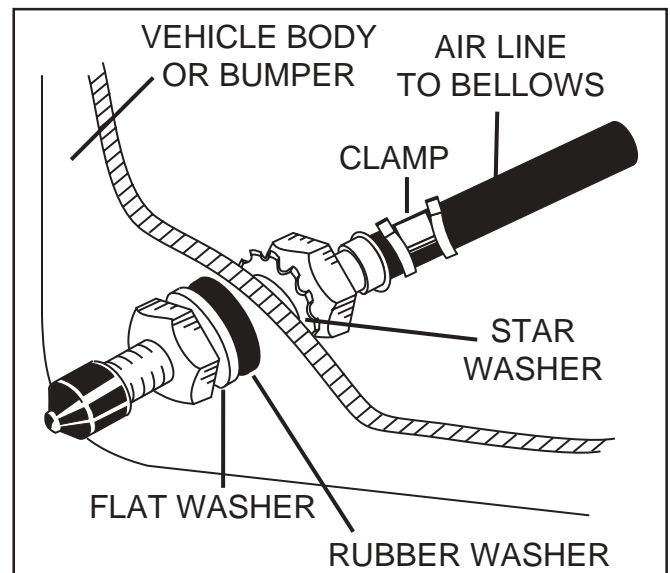

Figure 8

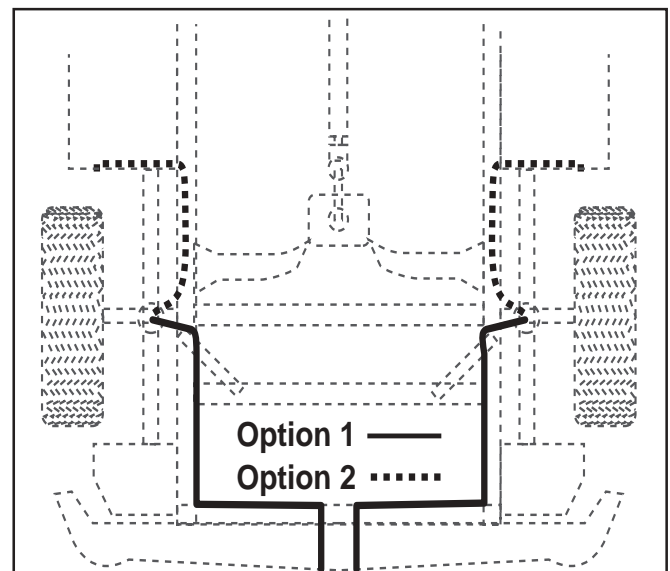

Figure 9

## Maintenance and Operations

MINIMUM AIR PRESSURE	MAXIMUM AIR PRESSURE
5 psi	35 psi

*By following these steps, vehicle owners should obtain the longest life and best results from their air springs.*

### Maintenance Tips:

1. Check the air pressure in the air springs weekly.
2. Always maintain at least the 5 p.s.i. air pressure to prevent chafing or coil pinch.
3. If you develop a leak in the system, use a soapy/water solution to check all air line connections and the valve core before removing the cylinder.

### Operating Tips:

1. Inflate your air springs to 35 p.s.i. before adding the payload. This will allow the air cylinder to properly mesh with the coil spring. After vehicle is loaded, adjust your air pressure (down) to level the vehicle and for ride comfort.
2. When you are carrying a payload it will be helpful to increase the tire inflation pressure in proportion to any overload condition. We recommend a 2 p.s.i. increase above normal (not to exceed tire manufacturers maximum) for each 100 lbs. additional load on the axle.

*CAUTION: Do not exceed the vehicle manufacturers maximum gross vehicle weight rating.*

*CAUTION: Failure to maintain minimum pressure will void the warranty.*



# Product Use Information

## Frequently asked questions

**Q. Will installing air springs increase the weight ratings of a vehicle?**

No. Adding air springs will not change the weight ratings (GAWR, GCWR and/or GVWR) of a vehicle. Exceeding the GVWR is dangerous and voids the Air Lift warranty.

**Q. Is it necessary to keep air in the air springs at all time and how much pressure will they need?**

The minimum air pressure should be maintained at all times. The minimum air pressure keeps the air spring in shape, ensuring that it will move throughout its travel without rubbing or wearing on itself.

**Q. Is it necessary to add a compressor system to the air springs?**

No. Air pressure can be adjusted with any type of compressor as long as it can produce sufficient pressure to service the springs. Even a bicycle tire pump can be used, but it's a lot of work.

**Q. How long should air springs last?**

If the air springs are properly installed and maintained they can last indefinitely.

**Q. Will raising the vehicle on a hoist for service work damage the air springs?**

No. The vehicle can be lifted on a hoist for short-term service work such as tire rotation or oil changes. However, if the vehicle will be on the hoist for a prolonged period of time, support the axle with jack stands in order to take the tension off of the air springs.

## Tuning the air pressure

Pressure determination comes down to three things — level vehicle, ride comfort, and stability.

**1. Level vehicle**

If the vehicle's headlights are shining into the trees or the vehicle is leaning to one side, then it is not level (fig. 1). Raise the air pressure to correct either of these problems and level the vehicle.

**2. Ride comfort**

If the vehicle has a rough and harsh ride it may be due to either too much pressure or not enough (fig. 2). Try different pressures to determine the best ride comfort.

**3. Stability**

Stability translates into safety and should be the priority, meaning the driver may need to sacrifice a perfectly level and comfortable ride. Stability issues include roll control, bounce, dive during braking and sponginess (fig. 3). Tuning out these problems usually requires an increase in pressure.

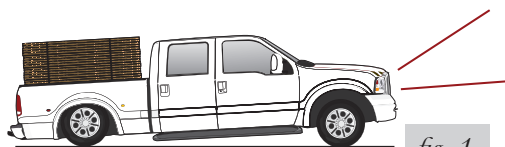

Bad headlight aim



Sway and body roll



Rough ride

### Guidelines for adding air:

1. Start with the vehicle level or slightly above.
2. When in doubt, always add air.
3. For motorhomes, start with 50-100 PSI in the rear because it can be safely assumed that it is heavily loaded.
4. If the front of the vehicle dives while braking, increase the pressure in the front air bags, if equipped.
5. If it is ever suspected that the air bags have bottomed out, increase the pressure (fig. 4).
6. Adjust the pressure up and down to find the best ride.
7. If the vehicle rocks and rolls, adjust the air pressure to reduce movement.
8. It may be necessary to maintain different pressures on each side of the vehicle. Loads such as water, fuel, and appliances will cause the vehicle to be heavier on one side (fig. 5). As much as a 50 PSI difference is not uncommon.

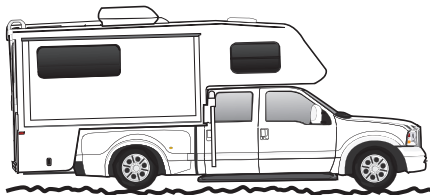

Bottoming out

*fig. 4*

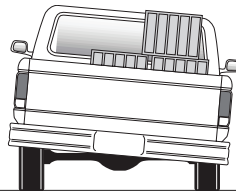

Unlevel

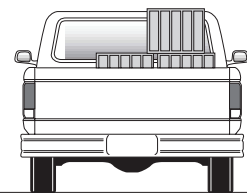

Level

*fig. 5*