

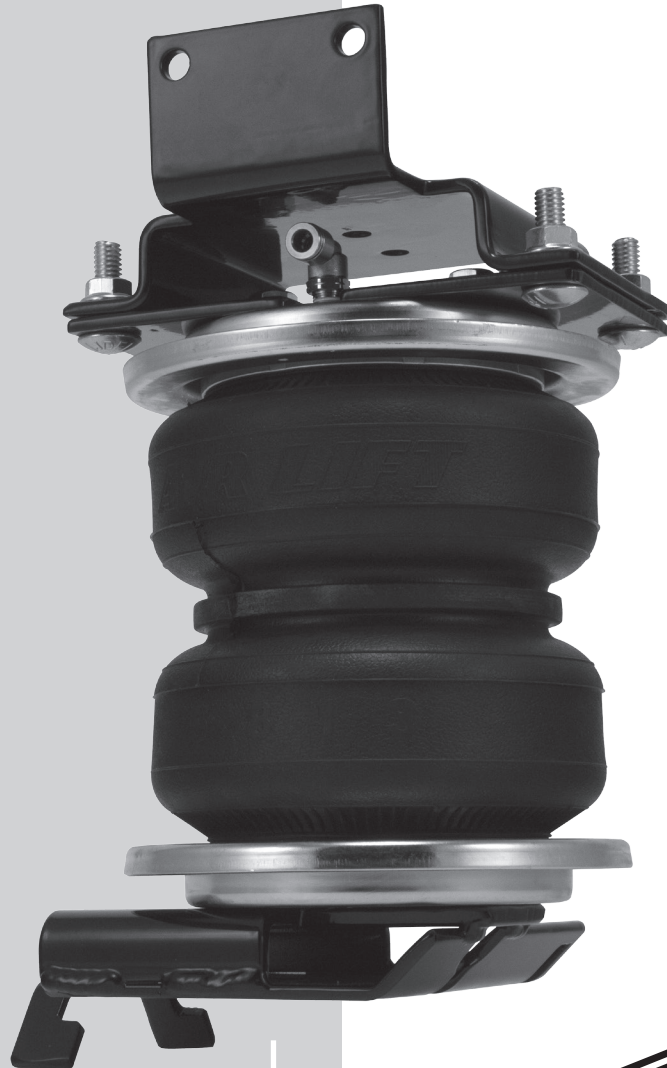
# LoadLIFTER™ 5000

by AIR LIFT®

# Kit 57365

**Dodge Ram 1500**

**2 & 4-Wheel Drive**



## INSTALLATION GUIDE

For maximum effectiveness and safety, please read these instructions completely before proceeding with installation.

*Failure to read these instructions can result in an incorrect installation.*

# TABLE OF CONTENTS

<b>Introduction</b> .....	<b>2</b>
Important Safety Notice .....	2
Notation Explanation .....	2
<b>Installation Diagram</b> .....	<b>3</b>
Hardware List .....	4
Tools List .....	4
<b>Installing the LoadLifter 5000 System</b> .....	<b>4</b>
Getting Started .....	4
Assembling the Air Springs .....	9
Installing the Assemblies .....	11
Installing the Air Lines .....	14
Installing the Heat Shield .....	16
Checking for Leaks .....	17
Fixing Leaks .....	17
Photos of Finished Assemblies .....	18
<b>Before Operating</b> .....	<b>19</b>
Installation Checklist .....	19
Post-Installation Checklist .....	19
<b>Product Use, Maintenance and Servicing</b> .....	<b>20</b>
Minimum and Maximum Pressure .....	20
Maintenance Guidelines .....	20
Troubleshooting Guide .....	20
Frequently Asked Questions .....	21
Tuning the Air Pressure .....	21
Guidelines for Adding Air .....	22
<b>Choosing the Right On-Board Air Compressor System</b> .....	<b>23</b>
<b>Limited Warranty and Return Policy</b> .....	<b>24</b>
<b>Replacement Information</b> .....	<b>25</b>
<b>Contact Information</b> .....	<b>25</b>

# Introduction

The purpose of this publication is to assist with the installation, maintenance and troubleshooting of the LoadLifter 5000 air spring kit. LoadLifter 5000 utilizes sturdy, reinforced, commercial-grade single- or double-bellows (depending on the kit). The bellows are manufactured like a tire with layers of rubber and cords that control growth. LoadLifter 5000 kits are recommended for most 3/4 and 1 ton pickups and SUVs with leaf springs, and provide up to 5,000 pounds of load-leveling support with air adjustability from 5-100 PSI. The kits are used in motor home rear applications and various front applications where leaf springs are used.

It is important to read and understand the entire installation guide before beginning installation or performing any maintenance, service or repair. The information here includes a hardware list, tool list, step-by-step installation information, maintenance guidelines and operating tips.

## IMPORTANT SAFETY NOTICE

The installation of this kit does not alter the Gross Vehicle Weight Rating (GVWR) or payload of the vehicle. Check your vehicle's owner's manual and do not exceed the maximum load listed for your vehicle.

**Gross Vehicle Weight Rating:** The maximum allowable weight of the fully loaded vehicle (including passengers and cargo). This number — along with other weight limits, as well as tire, rim size and inflation pressure data — is shown on the vehicle's Safety Compliance Certification Label.

**Payload:** The combined, maximum allowable weight of cargo and passengers that the truck is designed to carry. Payload is GVWR minus the Base Curb Weight.

## NOTATION EXPLANATION

Hazard notations appear in various locations in this publication. Information which is highlighted by one of these notations must be observed to help minimize risk of personal injury or possible improper installation which may render the vehicle unsafe. Notes are used to help emphasize areas of procedural importance and provide helpful suggestions. The following definitions explain the use of these notations as they appear throughout this guide.

INDICATES IMMEDIATE HAZARDS WHICH WILL RESULT IN SEVERE PERSONAL INJURY OR DEATH.



INDICATES HAZARDS OR UNSAFE PRACTICES WHICH COULD RESULT IN SEVERE PERSONAL INJURY OR DEATH.



INDICATES HAZARDS OR UNSAFE PRACTICES WHICH COULD RESULT IN DAMAGE TO THE MACHINE OR MINOR PERSONAL INJURY.

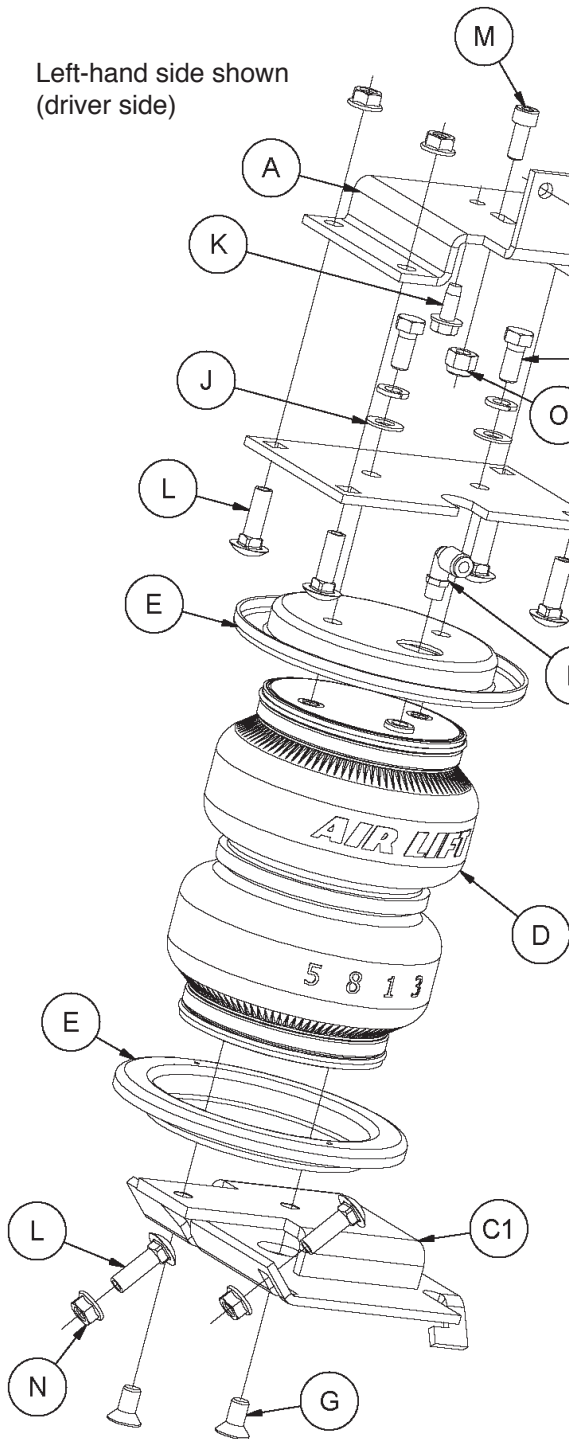


## NOTE

*Indicates a procedure, practice or hint which is important to highlight.*

# Installation Diagram

Left-hand side shown  
(driver side)



Right-hand side shown  
(passenger side)

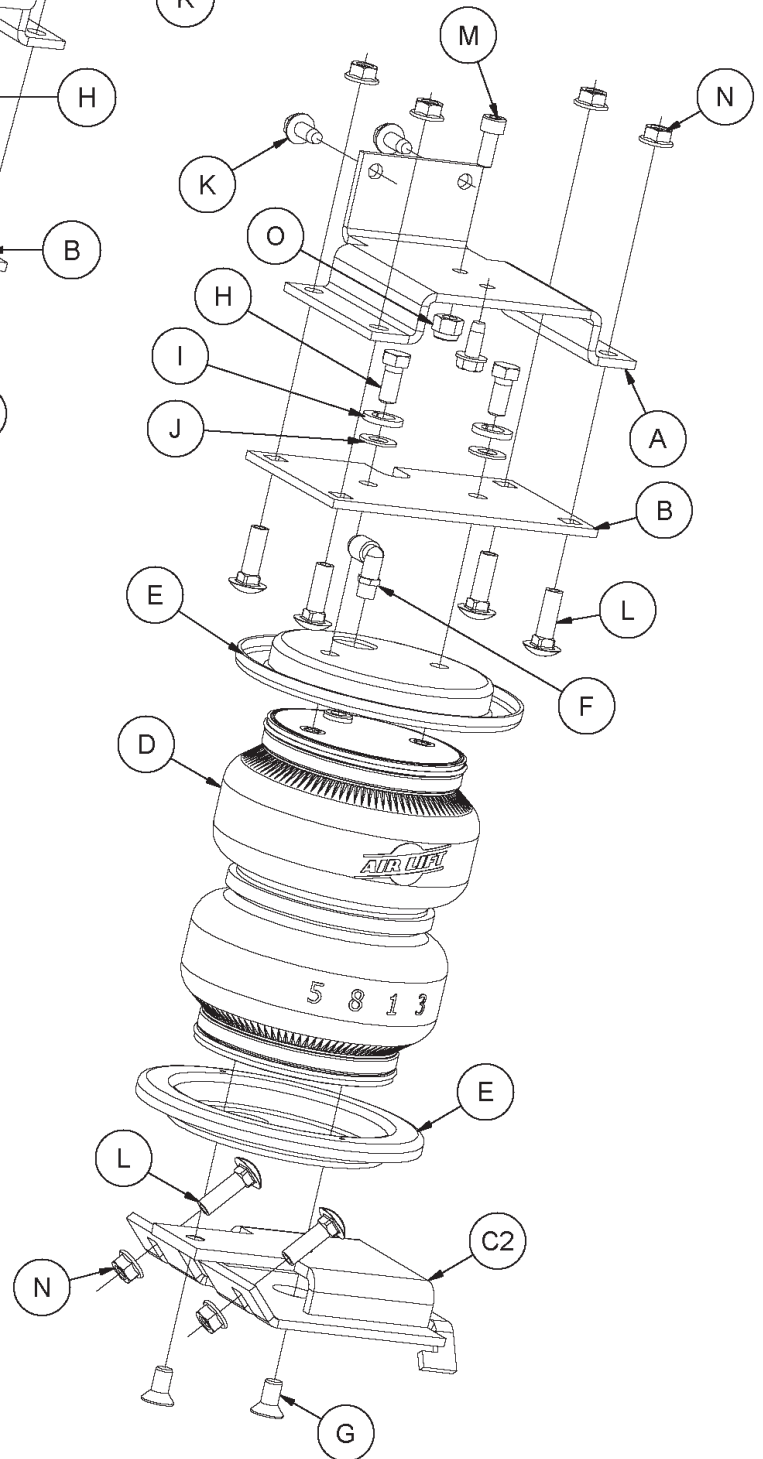


fig. 1

**NOTE: PROFESSIONAL MECHANICAL SKILLS ARE NECESSARY IN ORDER TO COMPLETE THE INSTALLATION OF THIS KIT.**

## HARDWARE LIST

Item	Part #	Description.....Qty	Item	Part #	Description.....Qty
A	07061	Frame bracket.....2	M	17495	M8-1.25 x 20 socket head screw .....2
B	07150	Air spring bracket.....2	N	18422	3/8"-16 serrated lock nut.....12
C1	03017	L.H. lower bracket.....1	O	18522	M8-1.25 nylon nut.....2
C2	03112	R.H. lower bracket.....1	AA*	20086	Air line assembly.....1
D	58437	Air spring.....2	BB*	10466	Tie strap.....6
E	11951	Roll plate.....4	CC*	21230	Valve cap.....2
F	21837	90° swivel fitting.....2	DD*	18501	5/16" flat washer.....2
G	17215	3/8"-24 x 3/4" flat head screw.....4	EE*	21234	Rubber washer.....2
H	17203	3/8"-24 x 7/8" hex head bolt.....4	FF*	18411	Star washer.....2
I	18427	3/8" lock washer.....4	GG*	21233	5/16" hex nut.....4
J	18444	3/8" flat washer.....4			
K	17102	5/16"-18 x 3/4" self-tapping screw.....6			
L	17361	3/8"-16 x 1.25" Carriage Bolt.....12			

\*Not shown in fig. 1.

## TOOLS LIST

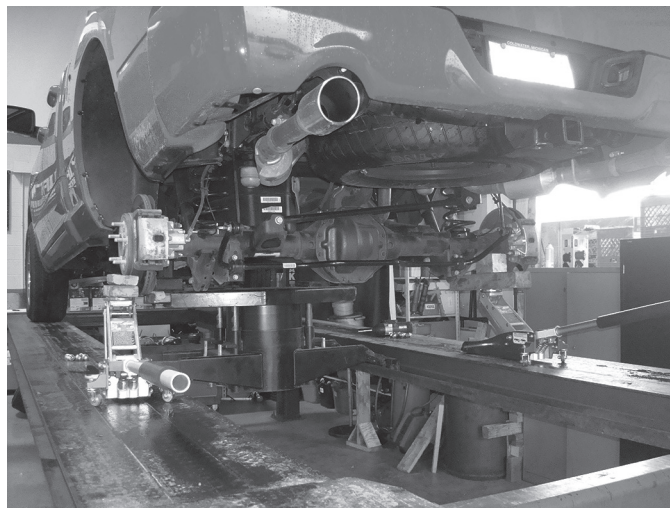
Description..... Qty	Description..... Qty
Hoist or floor jacks..... 1	7/32 allen wrench (socket if available)..... 1
Safety stands..... 2	1/4" and 5/16" drill bits (very sharp)..... 1
Safety glasses..... 1	Heavy duty drill..... 1
4" grinder or metal cutting tool..... 1	Hose cutter, razor blade, or sharp knife..... 1
Torque wrench..... 1	Air compressor or compressed air source..... 1
Standard open-end combo wrenches..... 1	Spray bottle with dish soap/water solution..... 1
Ratchet..... 1	Black paint or undercoating..... 1
Metric and standard sockets..... 1	

# Installing the LoadLifter 5000 System

## GETTING STARTED

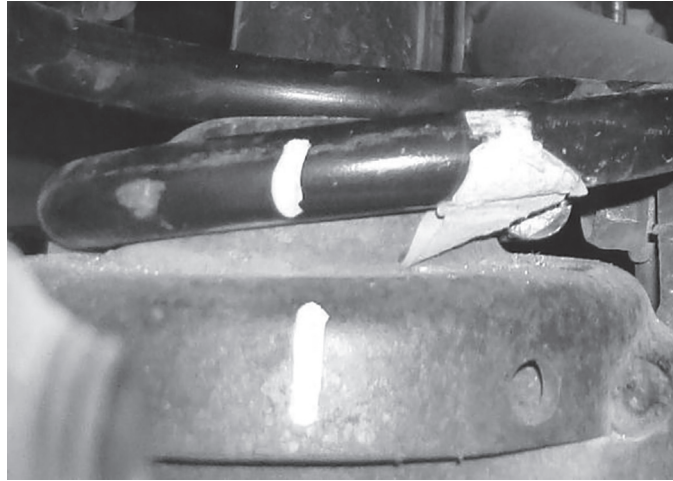
In order to install the upper frame brackets (A), it will be necessary to remove the coil springs as follows:

1. Lift the vehicle up and support the frame with jack stands. Leave enough room to drop the axle down low enough to remove the coil springs (Fig. 2). Remove the rear wheels.



*fig. 2*

2. Mark the bottom of the right-hand and left-hand coil springs and lower spring seat mounts with chalk or a paint marker to make sure the spring is put back the same way it is removed (Fig. 3).



*fig. 3*

3. Remove both lower shock bolts and slowly lower the axle until the springs can be removed.

## NOTE

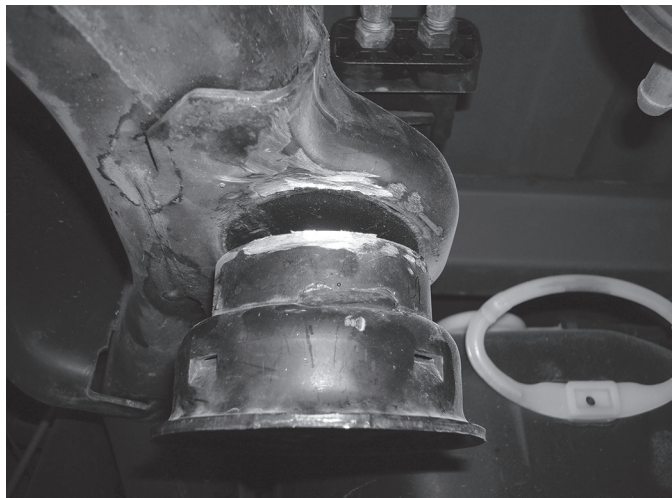
*Lower the axle carefully and avoid putting stress on the flexible brake lines.*

4. Remove both jounce bumpers from both sides (Fig. 4).



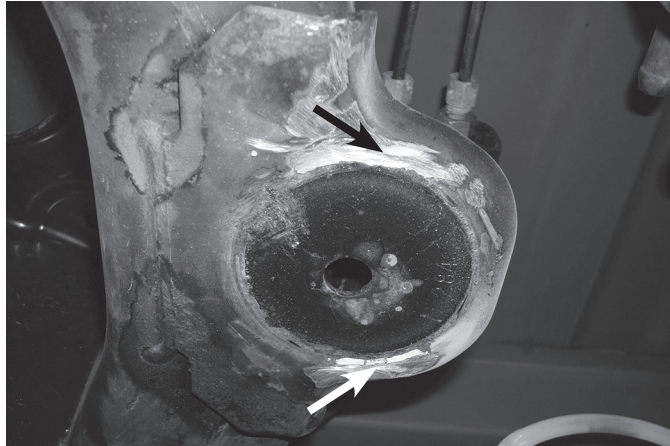
*fig. 4*

5. Grind the welds off the jounce bumper cups that attach them to the jounce bumper frame bracket (Fig. 5). Remove and discard from both sides of the vehicle.

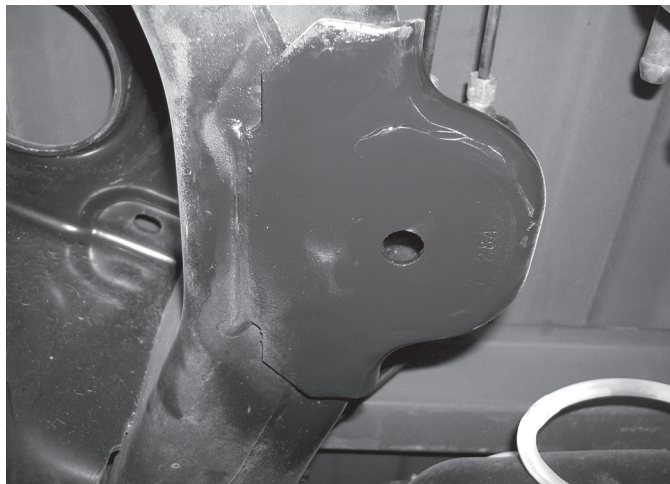


*fig. 5*

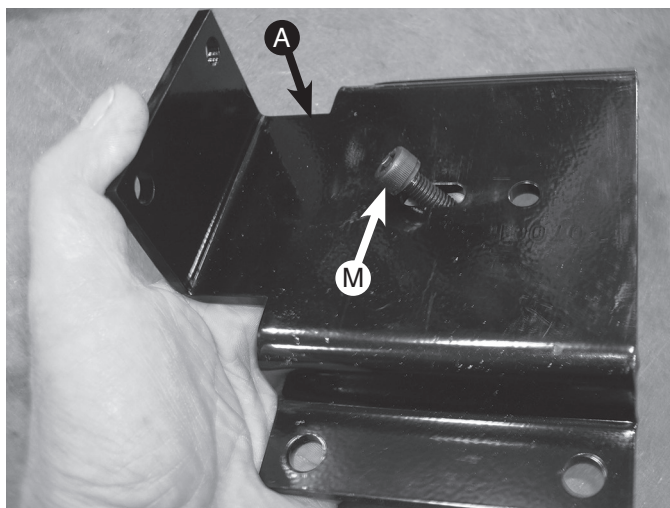
6. Grind the welds removed, down flush to the frame with the grinder. (Fig. 6).

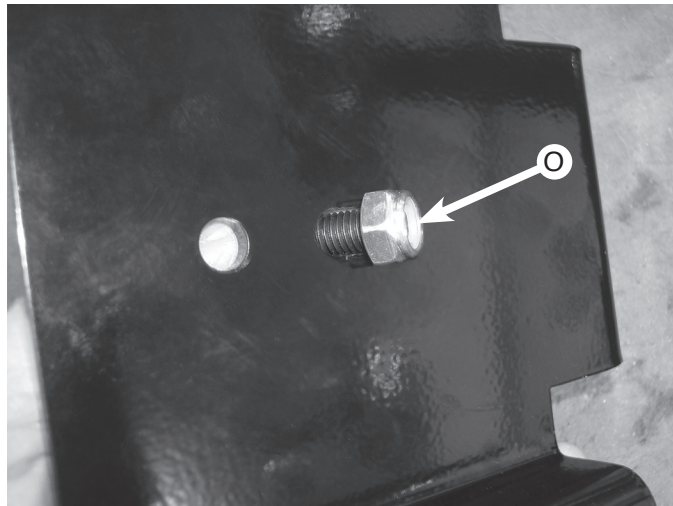
*fig. 6*

7. Spray the frame with black paint or undercoating to cover the bare surface, from grinding the welds flush previously (Fig. 7). Repeat for both sides.

*fig. 7*

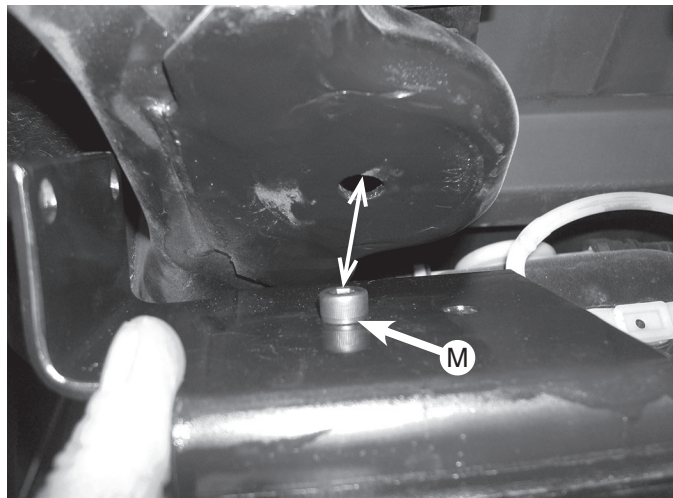
8. Install the socket head M8 bolt (M) into the frame bracket (A) slot closest to the flange on the bracket (Fig. 8). Note: The head points in the same direction as the flange on the bracket. Cap with the nylon lock nut (O) as shown (Fig. 9).

*fig. 8*



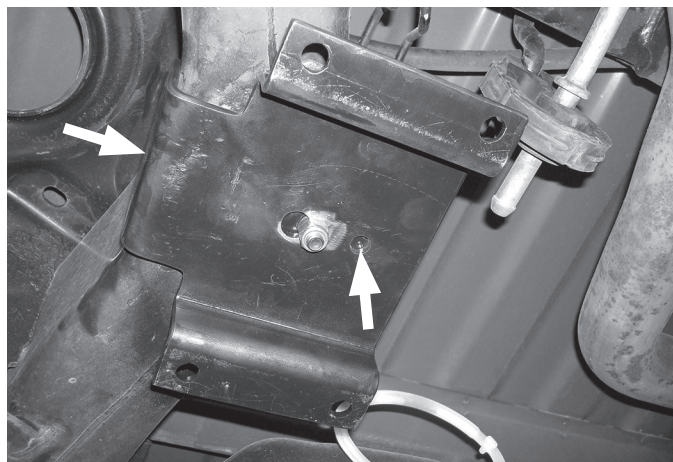
*fig. 9*

9. Only tighten the bolt to where it can still slide in the slot.
10. Set the frame bracket (with the socket head bolt in it), on the frame, with the flange pointing up. Insert the socket head bolt into the existing hole in the frame that was under the stock jounce bumper (Fig. 10).



*fig. 10*

11. The bracket should sit flush to the bottom of the frame. If there is any leftover weld holding the bracket off the frame, remove and grind down so the bracket is flush.
12. With the socket head bolt in the hole, push the flange against the side of the frame (Fig. 11) and mark the existing hole under the frame with a paint marker (Fig. 12).



*fig. 11*

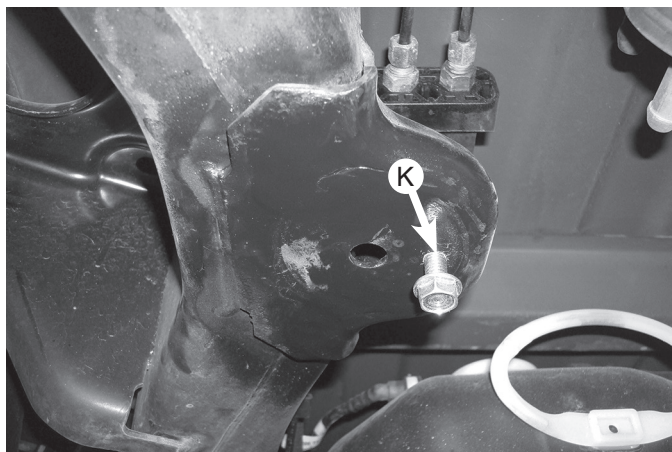


**TECHNICAL NOTE**

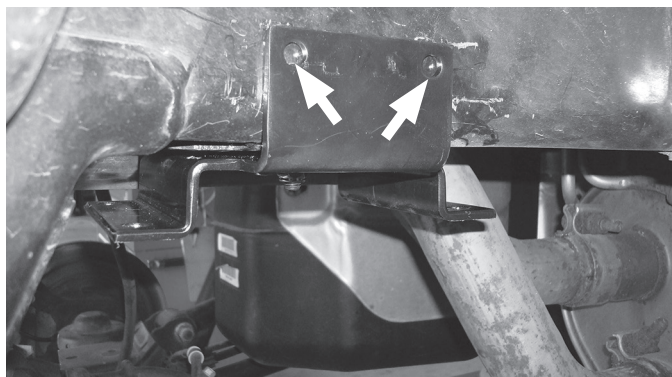
*If possible, with the bracket in position, use a 21/64 (or closest) centering punch to fit into the hole and center-punch the frame for an exact center of the hole.*

*fig. 12*

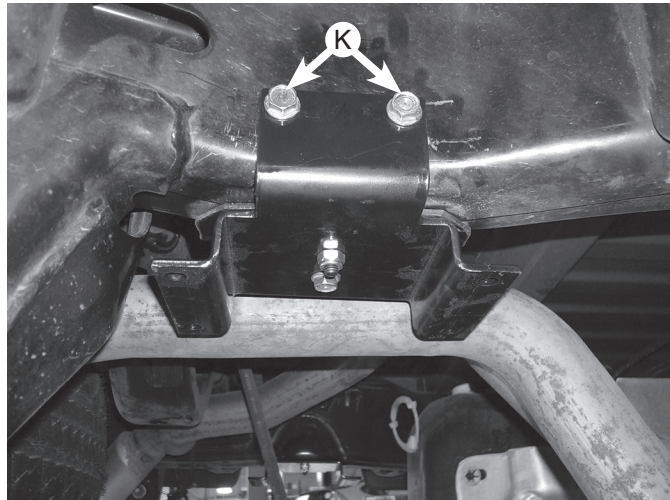
13. Center-punch the frame and drill a 1/4" hole (Fig. 13). Start a 5/16" self-tapping screw (K) into the hole, making sure it is straight, and tighten it enough to form the threads needed to set the screw (Fig. 13). Remove the screw once threads are formed. Repeat for both sides.

*fig. 13*

14. Set the bracket back in place on the frame and bolt into position using the self-tapping screw previously set into the frame. Tighten the screw making sure the washer head portion of the screw is flat to the bracket, and torque to 15 lb.-ft.
15. Make sure the bracket is flat to the bottom on the frame, center punch and drill through the frame with a 1/4" bit using the holes in the side of the flange as a guide (Fig. 14).

*fig. 14*

16. Install two more self-tapping screws (K) in the side, making sure the flat head portion of the bolt is flush to the bracket, and torque to 15 lb.-ft. (Fig. 15). Repeat for the other side.



Driver-side bracket shown mounted in place and ready for the air spring assembly.

fig. 15

17. Once the frame brackets have been installed on both sides, the stock suspension can be put back together.
18. Set the coil springs back into position using the index marks from the previous step and raise the axle back up making sure the spring indexes into the top and bottom spring seats correctly.
19. Install the wheels back on the axle and lower the vehicle back down so the wheels rest on the ground. Torque the lug nuts to the manufacturers torque specs.
20. Install the lower shock bolts back onto the axle and torque to 135Nm (100 lb.-ft.).

## ASSEMBLING THE AIR SPRINGS

1. Set a roll plate (E) onto the air spring (D).

### NOTE

*The radius (rounded) edge of the roll plate (E) will be towards the air spring, so that the air spring is seated inside both roll plates.*

2. Install the swivel fitting (F) into the top of the air spring finger-tight plus one-and-a-half turns (Fig. 16). Repeat for both air springs.

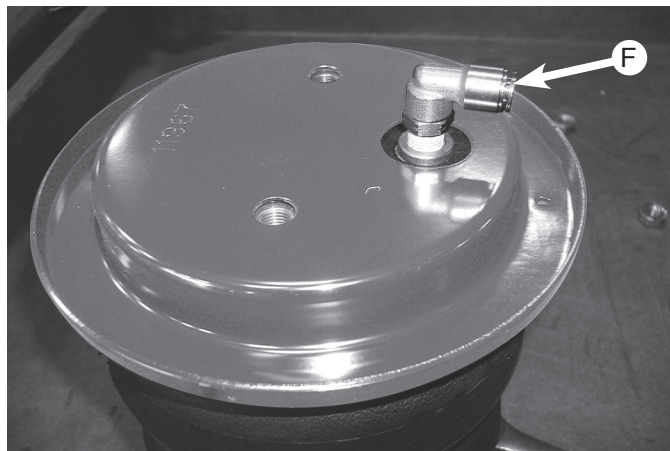
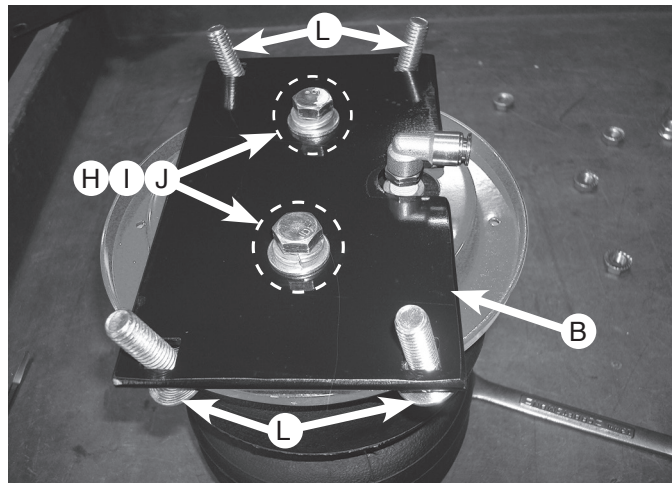
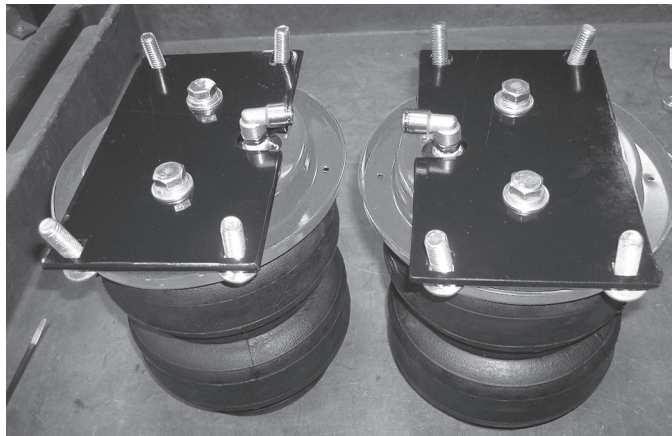


fig. 16

3. Insert four carriage bolts (L) into the upper air spring bracket (B) and set the upper bracket onto the air spring assembly (Fig. 17).
4. Attach the upper air spring bracket using two 3/8" hex head bolts (H), two lock washers (I) and two flat washers (J). Torque to no more than 20 lb.-ft. Repeat for the opposite side. Both upper assemblies shown in Figure 18.


*fig. 17*

*fig. 18*

5. Flip the air spring assemblies upside down and set a roll plate (E) over the air spring (same as in step one).
6. Position the air spring assemblies so that the fittings are outboard and away from each other (Fig. 19).


*fig. 19*
**NOTE**

*The finished assemblies will be left and right-hand specific, and the fittings that are on the top of the air springs should be facing the outside (tire side) of the vehicle once into position.*

7. Set the left-hand lower bracket (C1) onto the left side assembly (your left-hand facing both assemblies) and attach with two 3/8" flat head screws (G). Torque to no more than 20 lb.-ft. (Fig. 19). Attach the right-hand lower bracket (C2) onto the right-side assembly (your right-hand facing both assemblies). Attach with two 3/8" flat head screws (G). Torque to no more than 20 lb.-ft. (Fig. 20).

Left side assembly (driver side) using Lower Bracket (C1).

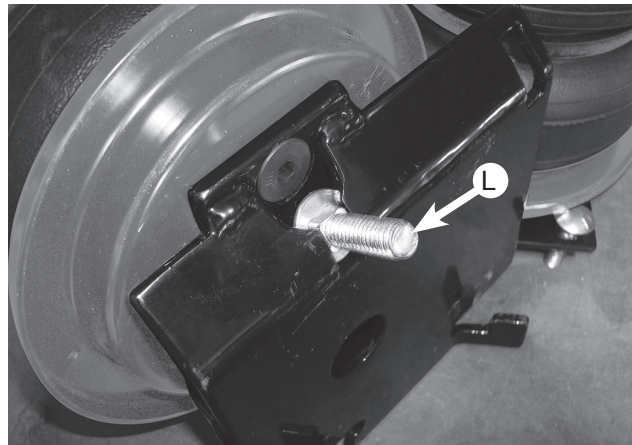


Right-side assembly (passenger side) using lower bracket (C2).

*fig. 20*

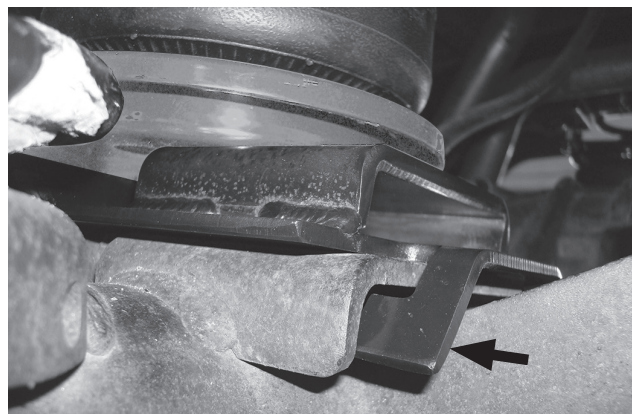
### INSTALLING THE ASSEMBLIES

1. Index a 3/8" carriage bolt (L) into the opening on the front of the driver side assembly as shown (Fig. 21).

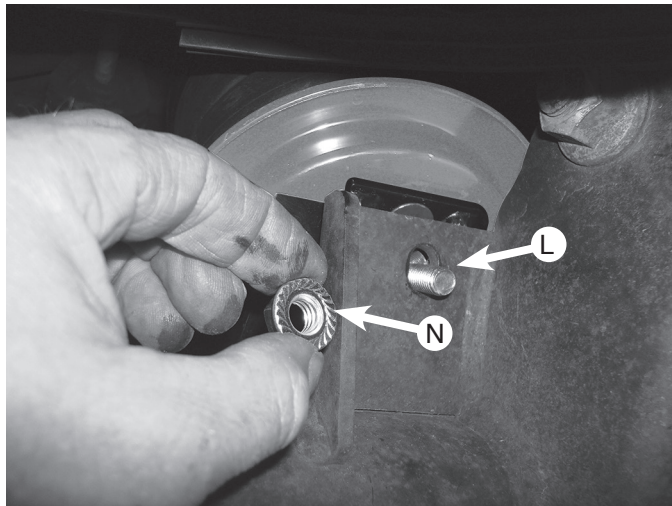


*fig. 21*

2. Drop the axle again to gain clearance to put the two assemblies into position on the axle.
3. Set the driver side assembly into position with the carriage bolt still in the slot (previously installed). Set into place on the axle making sure the back of the bracket is "hooked" below the jounce bumper strike plate. Push the assembly forward while lining up the carriage bolt with the existing hole in the front of the lower jounce bumper strike plate (Figs. 22 and 23). Cap the carriage bolt with a 3/8" serrated lock nut (N), but leave loose at this time.



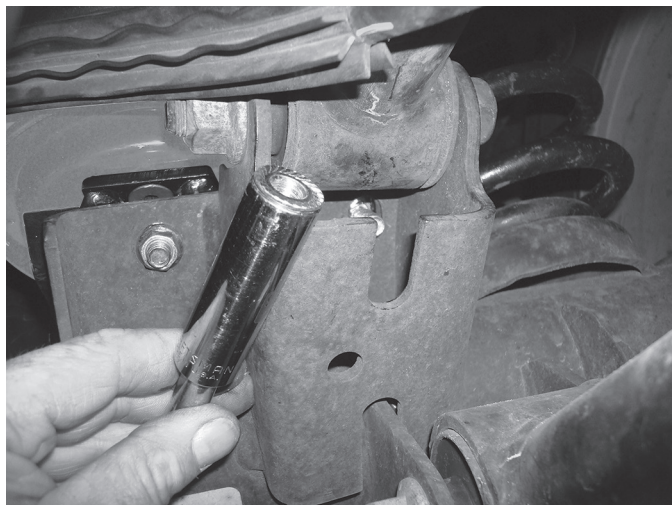
*fig. 22*

*fig. 23*

4. Insert another 3/8" carriage bolt (L) through the remaining hole in the front side of the bracket (Fig. 24).

*fig. 24*

5. It will be necessary to use a socket with an extension to reach the inside threads on the carriage bolt previously set into position (Fig. 25). It may be helpful to pull the carriage bolt out slightly so that it can be angled enough to get started on the thread.



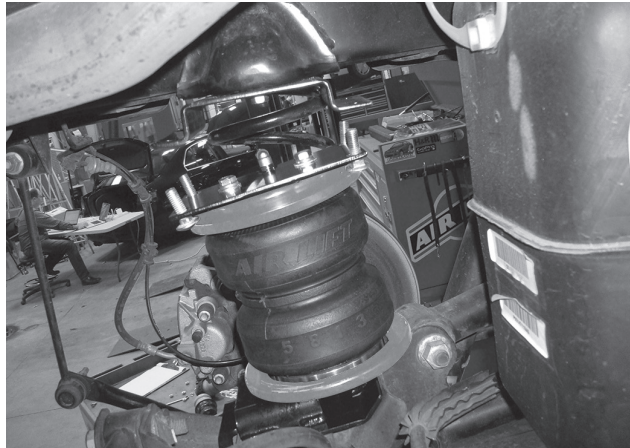
Use the slot in the lower control arm mount for the extension to fit through while threading the nut on the bolt.

*fig. 25*

6. Set the right hand unit assembly into position in the same way indexing the lower bracket with the tabs under the jounce bumper strike plate and, with the exception of using the slot for the carriage bolt in the lower bracket, install the carriage bolts in the same manner. Torque both sides of the lower bracket hardware evenly to 31 lb.-ft. making sure the tabs are still indexed under the jounce bumper strike plate. Figures 26 and 27 show the assemblies bolted into position.

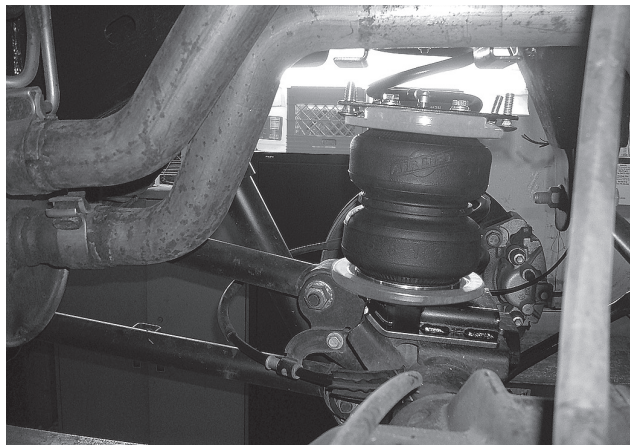
**NOTE**

*Fittings should be on the outside (tire side) of the assemblies.*



Left-hand assembly shown.

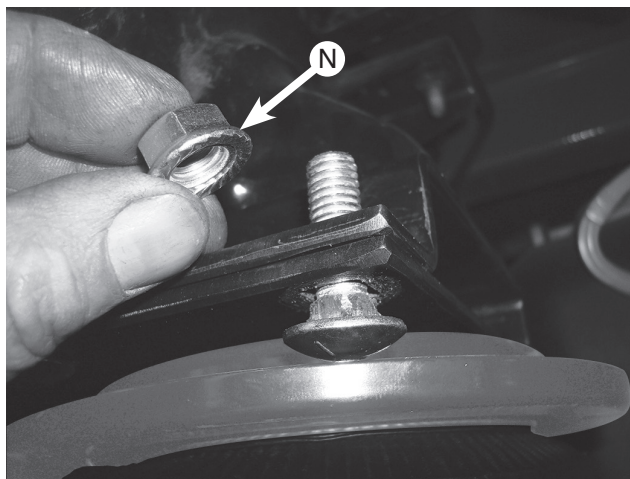
*fig. 26*



Right-hand assembly shown.

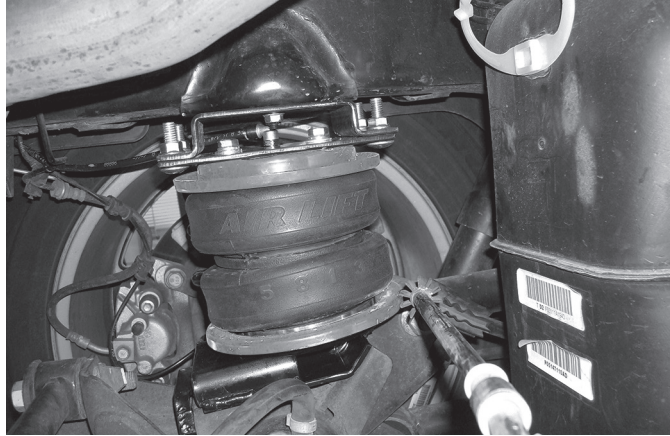
*fig. 27*

7. Raise the axle back up while aligning the air spring mounting plate's carriage bolts, with the frame mounting bracket holes. Cap all carriage bolts, once in position, with 3/8" serrated lock nuts (N) and torque all the installed nuts to 31 lb.-ft. (Fig. 28).



*fig. 28*

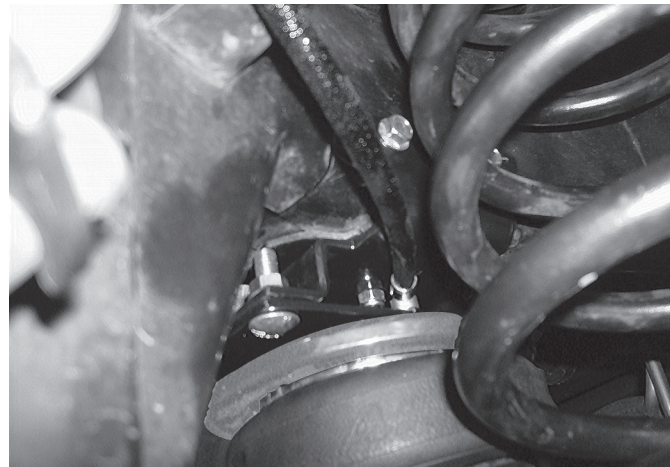
8. Left-side shown with the assembly bolted up to the frame bracket (Fig. 29).



*fig. 29*

## INSTALLING THE AIR LINES

1. On the passenger side only, place the provided thermal sleeve (HH) on the air line near the exhaust.
2. Remove the air line heat shield sleeve in the hose heat shield kit and install on the right side (passenger side) air line where it attaches to the fitting on the upper bracket (Fig. 30).



Insert the air line into the heat shield before attaching to the right-side (passenger) air spring fitting.

*fig. 30*

3. Choose a convenient location for mounting the inflation valves. Popular locations for the inflation valve are:
  - a. The wheel well flanges.
  - b. License plate recess in bumper.
  - c. Under the gas cap access door.
  - d. Through license plate itself.

### NOTE

*What ever the chosen location is, make sure there is enough clearance around the inflation valves for an air chuck.*

4. Drill a 5/16" hole to install the inflation valves.
5. Cut the air line assembly (AA) in two equal lengths.

### CAUTION

WHEN CUTTING OR TRIMMING THE AIR LINE, USE A HOSE CUTTER, A RAZOR BLADE OR A SHARP KNIFE. A CLEAN, SQUARE CUT WILL ENSURE THAT THE LINE WILL NOT LEAK. DO NOT USE WIRE CUTTERS OR SCISSORS TO CUT THE AIR LINE. THESE TOOLS MAY FLATTEN OR CRIMP THE AIR LINE, CAUSING IT TO LEAK AROUND THE O-RING SEAL INSIDE THE ELBOW FITTING (FIG. 31)

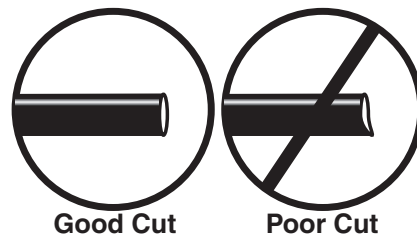


fig. 31

- Place a 5/16" hex nut (GG) and a star washer (FF) on the air valve. Leave enough of the inflation valve in front of the nut to extend through the hole and have room for the rubber washer (EE), flat washer (DD), and 5/16" hex nut (GG) and valve cap (CC). There should be enough valve exposed after installation - approximately 1/2" - to easily apply a pressure gauge or an air chuck (Fig. 32).
- Push the inflation valve through the hole and use the rubber washer (EE), flat washer (DD), and another 5/16" hex nut (GG). Tighten the nuts to secure the assembly in place (Fig. 32).

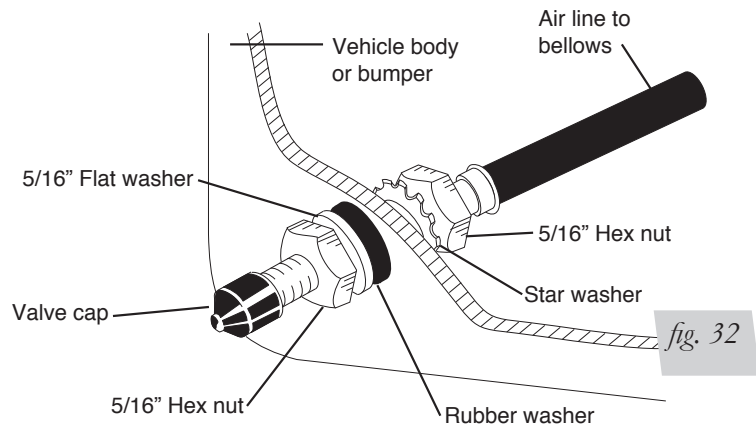


fig. 32

- Route the air line along the frame to the air fitting on the air spring (Fig. 33). Keep AT LEAST 6" of clearance between the air line and heat sources, such as the exhaust pipes, muffler, or catalytic converter. Avoid sharp bends and edges. Use the plastic tie straps (BB) to secure the air line to fixed, non-moving points along the chassis. Be sure that the tie straps are tight, but do not pinch the air line. Leave at least 2" of slack to allow for any movement that might pull on the air line.

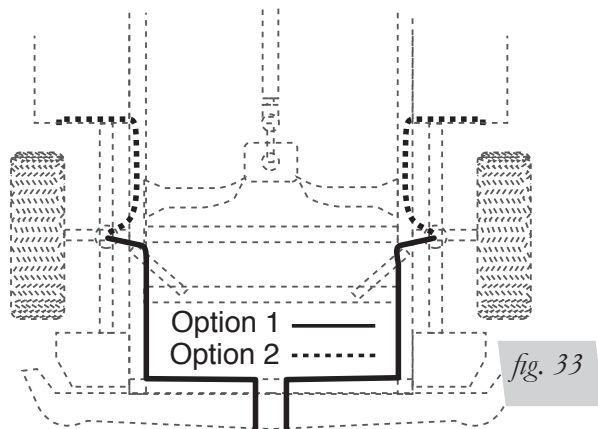


fig. 33

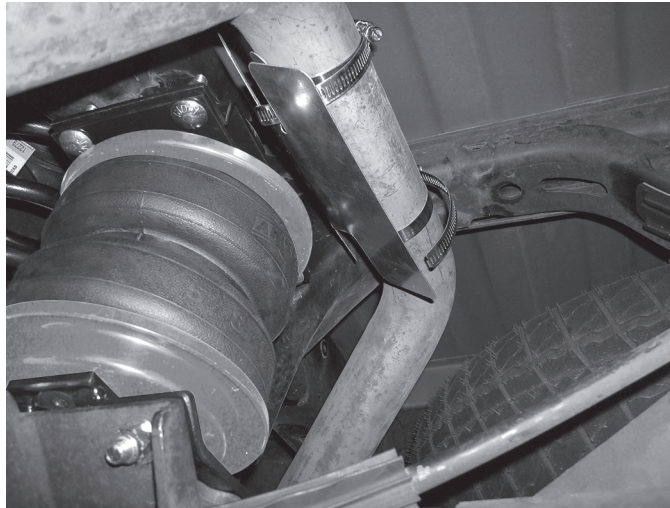
- Cut off air line, leaving approximately 12" of extra air line. A clean square cut will ensure that the line will not leak (see Fig. 31). Insert the air line into the air fitting. This is a push-to-connect fitting. Simply push the air line into the 90° swivel fitting until it bottoms out (9/16" of air line should be in the fitting).



## INSTALLING THE HEAT SHIELD

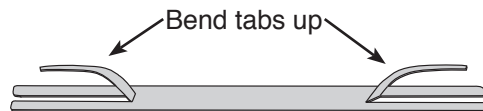
**NOTE**

*Finished photo of heat shield installed on right-side (passenger) exhaust (Fig. 34).*



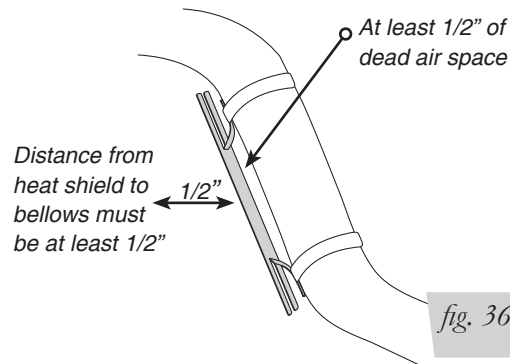
*fig. 34*

1. Bend the tabs on the heat shield to provide a 1/2" dead air space between exhaust pipe and heat shield (Fig. 35).



*fig. 35*

2. Attach the heat shield to the exhaust pipe using the clamps (Fig. 36). Bend the heat shield for maximum clearance to the air spring.



*fig. 36*

## CHECKING FOR LEAKS

1. Inflate the air spring to 30 PSI and spray all connections and the inflation valves with a solution of 1/5 liquid dish soap and 4/5 water to check for leaks. Spot leaks easily by looking for bubbles in the soapy water.
2. After the test, deflate the springs to the minimum pressure required to restore the normal ride height, no less than 5 PSI.
3. Check the air pressure again after 24 hours. A 2-4 PSI loss after initial installation is normal. Retest for leaks if the loss is more than 5 lbs.

## FIXING LEAKS

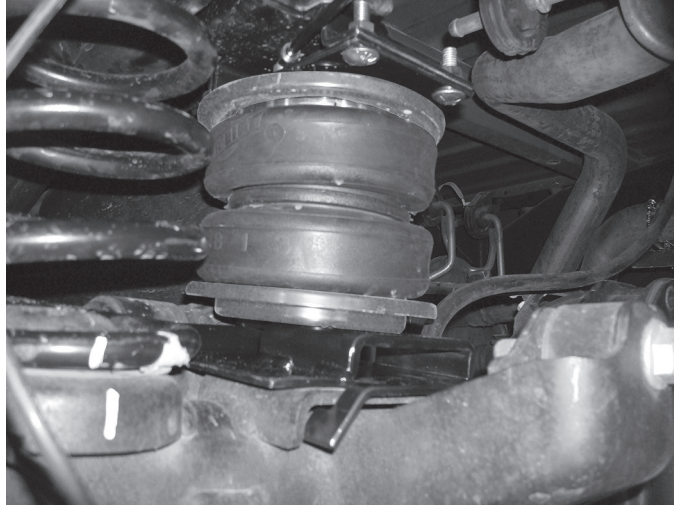
1. If there is a problem with the swivel fitting:
  - a. Check the air line connection by deflating the spring and removing the line by pulling the collar against the fitting and pulling firmly on the air line. Trim 1" off the end of the air line. Be sure the cut is clean and square (see Fig. 31). Reinsert the air line into the push-to-connect fitting.
  - b. Check the threaded connection by tightening the swivel fitting another 1/2 turn. If it still leaks, deflate the air spring, remove the fitting, and re-coat the threads with thread sealant. Reinstall by hand tightening as much as possible, then use a wrench for an additional two turns.
2. If there is a problem with the inflation valve, then:
  - a. Check the valve core by tightening it with a valve core tool.
  - b. Check the air line connection by removing the air line from the barbed type fitting.



**DO NOT CUT THE AIR LINE COMPLETELY OFF AS THIS WILL NICK THE BARB AND RENDER THE FITTING USELESS.**

## PHOTOS OF FINISHED ASSEMBLIES

1. Back view of left-side (driver) assembly (Fig. 37).



*fig. 37*

2. Back view of right-side (passenger) assembly (Fig. 38).



*fig. 38*

# Before Operating

## INSTALLATION CHECKLIST (To be completed by installer)

- Clearance test — Inflate the air springs to 60 PSI and ensure there is at least 1/2" clearance around each bellow, away from anything that might rub against them. Be sure to check the tire, brake drum, frame, shock absorbers and brake cables.
- Leak test before road test — Inflate the air springs to 60 PSI, check all connections for leaks with a soapy water solution. See the *Checking for Leaks* section for tips on how to spot leaks. All leaks must be eliminated before the vehicle is road tested.
- Heat test — Be sure there is sufficient clearance from any heat sources — at least 6" for air springs and air lines. If a heat shield was included in the kit, install it. If there is no heat shield, but one is required, call (800) 248-0892.
- Fastener test — Recheck all bolts for proper torque. Re-torque after 100 miles.
- Road test — The vehicle should be road tested after the preceding tests. Inflate the air springs to 25 PSI (50 PSI if the vehicle is loaded). Drive the vehicle 10 miles and recheck for clearance, loose fasteners and air leaks.
- Operating instructions — If professionally installed, the installer should review the *Product Use, Maintenance and Servicing* section with the owner. Be sure to provide the owner with all of the paperwork which came with the kit.

**Technician's Signature** \_\_\_\_\_

**Date** \_\_\_\_\_

## POST-INSTALLATION CHECKLIST

- Overnight leak down test — Recheck air pressure after the vehicle has been used for 24 hours. If the pressure has dropped more than 5 PSI, then there is a leak that must be fixed. Either fix the leak yourself or return to the installer for service.
- Air pressure requirements — Regardless of load, the air pressure should always be adjusted to maintain ride height at all times.
- Thirty day or 500 mile test — Recheck the air spring system after 30 days or 500 miles, whichever comes first. If any part shows signs of rubbing or abrasion, the source should be identified and moved, if possible. If it is not possible to relocate the cause of the abrasion, the air spring may need to be remounted. If professionally installed, the installer should be consulted. Check all fasteners for tightness.

# Product Use, Maintenance and Servicing

Minimum Recommended Pressure	Maximum Air Pressure
5 PSI	100 PSI

## MAINTENANCE GUIDELINES

### NOTE

*By following the steps below, vehicle owners will obtain the longest life and best results from their air springs.*

1. Check the air pressure weekly.
2. Always maintain normal ride height. Never inflate beyond 100 PSI.
3. If you develop an air leak in the system, use a soapy water solution (1/5 liquid dish soap and 4/5 water) to check all air line connections and the inflation valve core before deflating and removing the air spring.



### CAUTION

FOR YOUR SAFETY AND TO PREVENT POSSIBLE DAMAGE TO YOUR VEHICLE, DO NOT EXCEED MAXIMUM GROSS VEHICLE WEIGHT RATING (GVWR), AS INDICATED BY THE VEHICLE MANUFACTURER. ALTHOUGH YOUR AIR SPRINGS ARE RATED AT A MAXIMUM INFLATION PRESSURE OF 100 P.S.I., THE AIR PRESSURE ACTUALLY NEEDED IS DEPENDANT ON YOUR LOAD AND GVWR.

4. Loaded vehicles require at least 25 PSI or more. A “loaded vehicle” refers to a vehicle with a heavy bed load, a trailer, or both. As discussed above, never exceed GVWR, regardless of air spring, air pressure, or other load assist. The springs in this kit will support approximately 40 lbs. of load (combined on both springs) for each 1 PSI of pressure. The required air pressure will vary depending on the state of the original suspension. Operating the vehicle below the minimum air spring pressure will void the Air Lift warranty.
5. When increasing load, always adjust the air pressure to maintain the normal ride height. Increase or decrease pressure from the system as necessary to attain normal ride height for optimal ride and handling. Remember that loads carried behind the axle (including tongue loads) require more leveling force (pressure) than those carried directly over the axle.
6. Always add air to springs in small quantities, checking the pressure frequently.
7. Should it become necessary to raise the vehicle by the frame, make sure the system is at minimum pressure (5 PSI) to reduce the tension on the suspension/brake components. Use of on board leveling systems do not require deflation or disconnection.
8. Periodically check the air spring system fasteners for tightness. Also, check the air springs for any signs of rubbing. Realign if necessary.
9. On occasion, give the air springs a hard spray with a garden hose in order to remove mud, sand, gravel or other abrasive debris.

## TROUBLESHOOTING GUIDE

1. Leak test the air line connections, the threaded connection into the air spring, and all fittings in the control system.
2. Inspect the air lines to be sure none are pinched. Tie straps may be too tight. Loosen or replace the strap and replace leaking components.
3. Inspect the air line for holes and cracks. Replace as needed.
4. Look for a kink or fold in the air line. Reroute as needed.

## FREQUENTLY ASKED QUESTIONS

### Q. Will installing air springs increase the weight ratings of a vehicle?

No. Adding air springs will not change the weight ratings (GAWR, GCWR and/or GVWR) of a vehicle. Exceeding the GVWR is dangerous and voids the Air Lift warranty.

### Q. Is it necessary to keep air in the air springs at all times and how much pressure will they need?

For LoadLifter 5000 Ultimate, the recommended minimum air pressure is 5 PSI, but it can safely be run at zero air pressure.

### Q. Is it necessary to add a compressor system to the air springs?

No. Air pressure can be adjusted with any type of compressor as long as it can produce sufficient pressure to service the springs. Even a bicycle tire pump can be used, but it's a lot of work.

### Q. How long should air springs last?

If the air springs are properly installed and maintained they can last indefinitely.

### Q. Will raising the vehicle on a hoist for service work damage the air springs?

No. The vehicle can be lifted on a hoist for short-term service work such as tire rotation or oil changes. However, if the vehicle will be on the hoist for a prolonged period of time, support the axle with jack stands in order to take the tension off of the air springs.

## TUNING THE AIR PRESSURE

Pressure determination comes down to three things — level vehicle, ride comfort, and stability.

### 1. Level vehicle

If the vehicle's headlights are shining into the trees or the vehicle is leaning to one side, then it is not level (Fig. 2.1). Raise the air pressure to correct either of these problems and level the vehicle.

### 2. Ride comfort

If the vehicle has a rough or harsh ride it may be due to either too much pressure or not enough (Fig. 2.2). Try different pressures to determine the best ride comfort.

### 3. Stability

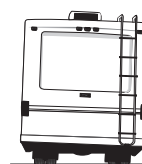
Stability translates into safety and should be the priority, meaning the driver may need to sacrifice a perfectly level and comfortable ride. Stability issues include roll control, bounce, dive during braking and sponginess (Fig. 2.3). Tuning out these problems usually requires an increase in pressure.



Bad headlight aim *fig. 2.1*



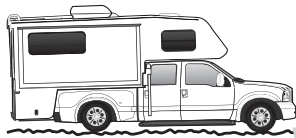
Rough ride *fig. 2.2*



Sway and body roll *fig. 2.3*

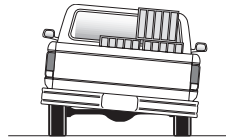
## GUIDELINES FOR ADDING AIR

1. Start with the vehicle level or slightly above.
2. When in doubt, always add air.
3. If the front of the vehicle dives while braking, increase the pressure in the front air bags, if equipped.
4. If it is ever suspected that the air bags have bottomed out, increase the pressure (Fig. 2.4).
5. Adjust the pressure up and down to find the best ride.
6. If the vehicle rocks and rolls, adjust the air pressure to reduce movement.
7. It may be necessary to maintain different pressures on each side of the vehicle. Loads such as water, fuel, and appliances will cause the vehicle to be heavier on one side (Fig. 2.5). As much as a 50 PSI difference is not uncommon.

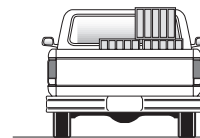


Bottoming out

*fig. 2.4*



Unlevel



Level

*fig. 2.5*

# Choosing the Right On-Board Air Compressor System

**60 DAY** NO QUESTIONS ASKED, MONEY-BACK GUARANTEE

**TWO-YEAR** COMPRESSOR SYSTEM WARRANTY

Add an on-board air compressor system to inflate and deflate your air springs automatically or with the touch of a button — from inside or outside of the vehicle.

- For convenient, on-the-go control of your air springs, add an Air Lift on-board air compressor system.
- Air Lift on-board air compressor systems eliminate the search for gas stations that have a working compressor, saving you time, energy and money.
- All systems include a compressor, controller and all parts needed for easy installation.

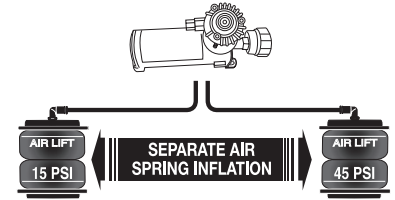
**1. Choose single or dual path inflation (see illustrations at right)**

**2. Choose wireless, analog control or automatic**

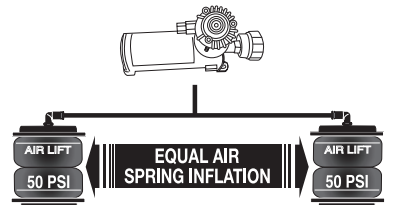
- **Wireless:** Control your air springs from inside or outside the vehicle. Easiest installation — no wires to the cab.
- **Analog:** In-cab control of your air springs. Economically priced.
- **Automatic:** Self-leveling system, keeps the vehicle level no matter what.

**3. Choose heavy or standard duty compressor**

- **Standard duty:** A standard duty compressor will work well for most customers who use their system on an intermittent basis.
- **Heavy duty:** For daily use, consider the heavy-duty compressor — it inflates faster and more quietly than the standard compressor.



**Dual path systems** Air springs are controlled separately to allow for different air pressure from side-to-side. Perfect for uneven or top-heavy loads.



**Single path systems** Two springs will inflate at the same time. Good for loads that are evenly distributed from left-to-right or front-to-back.

WIRELESS

ANALOG

AUTOMATIC

DUAL PATH

**WirelessAIR™**

OUR PREMIUM SYSTEM!

- Easy installation
- Includes heavy-duty compressor



P/N 72000

SINGLE PATH

**WirelessONE™**

- Easy installation
- Includes standard-duty compressor



P/N 25870

**LoadCONTROLLER™**

**Dual**

Compact, economically priced control.



P/N Standard Duty Compressor 25850; P/N Heavy Duty Compressor 25854

**LoadCONTROLLER™**

**Single**

Compact, economically priced control.



P/N Standard Duty Compressor 25852; P/N Heavy Duty Compressor 25856

**SmartAIR™ II**

- Easy installation
- Automatic self-leveling system
- No in-cab controls required



Single Path P/N 25490, Dual Path P/N 25491