

# LoadLIFTER™ 5000

by AIR LIFT®

## Kit 57233



## INSTALLATION GUIDE

For maximum effectiveness and safety, please read these instructions completely before proceeding with installation.

*Failure to read these instructions can result in an incorrect installation.*



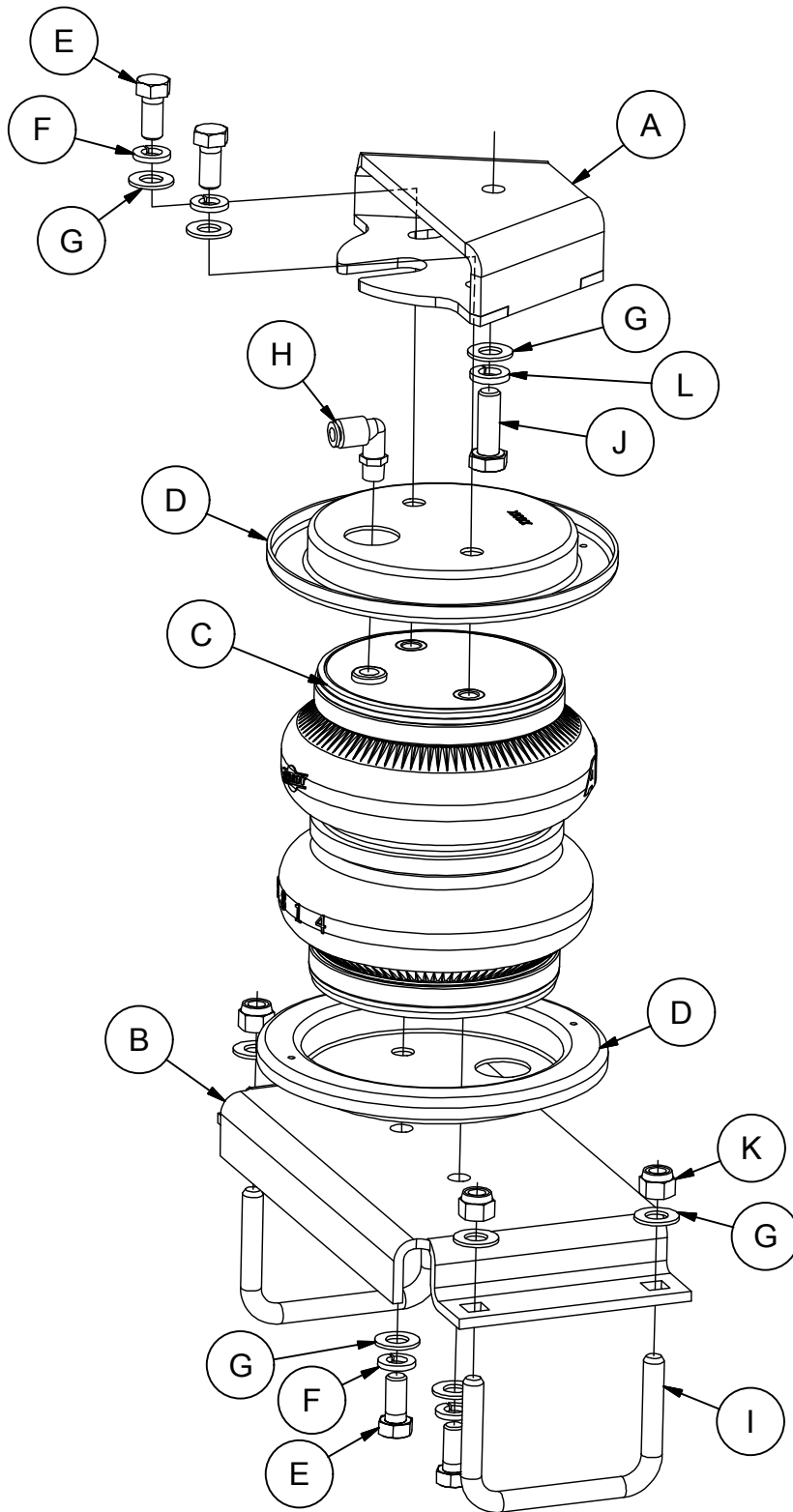
# TABLE OF CONTENTS



<b>A. Installation Diagram</b> . . . . .	<b>2</b>
<b>B. Hardware List and Tools List</b> . . . . .	<b>3</b>
Hardware List . . . . .	3
Tools List . . . . .	3
<b>C. Introduction</b> . . . . .	<b>4</b>
Important Safety Notice . . . . .	4
Notation Explanation . . . . .	4
<b>D. Installing the LoadLifter Ultimate 5000 System</b> . . . . .	<b>5</b>
Getting Started . . . . .	5
Assembling the Air Springs . . . . .	6
Installing the Assemblies . . . . .	7
<b>E. Installing the Air Lines</b> . . . . .	<b>9</b>
Tips for Installing Air Lines . . . . .	11
Installing the Heat Shield . . . . .	11
<b>F. Finished Installation Photos</b> . . . . .	<b>12</b>
<b>G. Before Operating</b> . . . . .	<b>13</b>
Checking for Leaks . . . . .	13
Fixing Leaks . . . . .	13
Installation Checklist . . . . .	14
Post-Installation Checklist . . . . .	14
<b>H. Product Use, Maintenance and Servicing</b> . . . . .	<b>15</b>
Minimum and Maximum Pressure . . . . .	15
Maintenance Guidelines . . . . .	15
Tuning the Air Pressure . . . . .	16
Guidelines for Adding Air . . . . .	16
<b>I. Frequently Asked Questions</b> . . . . .	<b>17</b>
<b>Limited Warranty and Returns Policy</b> . . . . .	<b>20</b>
<b>Replacement Part Information</b> . . . . .	<b>21</b>
<b>Contact Information</b> . . . . .	<b>21</b>



# A. Installation Diagram



*fig. A.1*

# B. Hardware and Tools Lists

## HARDWARE LIST

Item	Part #	Description	Qty
A	07909	Upper bracket .....	2
B	03910	Lower bracket .....	2
C	58439	Air spring .....	2
D	11951	Roll plate .....	4
E	17203	3/8"-24 x 7/8" Hex cap screw.....	8
F	18427	3/8" Lock washer .....	8
G	18444	3/8" Flat washer.....	18
H	21837	90° Swivel elbow fitting.....	2
I	10594	U-bolt.....	4
J	17160	M10 X 1.25 X 30 hex cap screw .....	2
K	18435	3/8"-16 Nylon lock nut .....	8
L	18540	M10 lock washer.....	2
M	20086	Hose assembly .....	1
N	10466	Zip ties .....	6
O	18501	5/16" Flat washer.....	2
P	18411	5/16" Star washer .....	2
Q	21230	Valve cap.....	2
R	21233	5/16" Hex nut.....	4
S	21234	Rubber washer.....	2

## TOOLS LIST

Description	Qty
Metric & STD open-box end wrenches .....	set
Ratchet with metric and STD sockets.....	set
Drill and 5/16" drill bit.....	1
Torque wrench.....	1
Hose cutter, razor blade or sharp knife .....	1
Hoist or floor jack .....	1
Safety stands.....	2
Safety glasses .....	1
Air compressor or compressed air source .....	1
Spray bottle with dish soap/water solution.....	1

**\* NOTE:** The pictures in this manual show the LoadLifter 5000 Ultimate kit installation. Visually, the only difference is Ultimate kits have black roll plates and standard LoadLifter 5000 kits have silver roll plates.



LoadLifter 5000 Ultimate black roll plate



LoadLifter 5000 silver roll plate

## C. Introduction

The purpose of this publication is to assist with the installation, maintenance and troubleshooting of the LoadLifter 5000 air spring kit. LoadLifter 5000 utilizes sturdy, reinforced, commercial grade single or double, depending on the kit, convolute bellows. The bellows are manufactured like a tire with layers of rubber and cords that control growth. LoadLifter 5000 Ultimate kits are recommended for most 3/4- and 1-ton pickups and SUVs with leaf springs and provide up to 5,000 pounds of load leveling support with air adjustability from 5-100 PSI. The kits are also used in motor home rear kits and some motor home fronts where leaf spring are used.

It is important to read and understand the entire installation guide before beginning installation or performing any maintenance, service or repair. The information here includes a hardware list, tool list, step-by-step installation information, maintenance guidelines and operating tips.

Air Lift Company reserves the right to make changes and improvements to its products and publications at any time.

### IMPORTANT SAFETY NOTICE

The installation of this kit does not alter the gross vehicle weight rating (GVWR) or payload of the vehicle. Check your vehicle's owner's manual and do not exceed the maximum load listed for your vehicle.

**Gross vehicle weight rating:** The maximum allowable weight of the fully loaded vehicle (including passengers and cargo). This number — along with other weight limits, as well as tire, rim size and inflation pressure data — is shown on the vehicle's Safety Compliance Certification Label.

**Payload:** The combined, maximum allowable weight of cargo and passengers that the truck is designed to carry. Payload is GVWR minus the base curb weight.

### NOTATION EXPLANATION

Hazard notations appear in various locations in this publication. Information which is highlighted by one of these notations must be observed to help minimize risk of personal injury or possible improper installation which may render the vehicle unsafe. Notes are used to help emphasize areas of procedural importance and provide helpful suggestions. The following definitions explain the use of these notations as they appear throughout this guide.



**DANGER**

INDICATES IMMEDIATE HAZARDS WHICH WILL RESULT IN SEVERE PERSONAL INJURY OR DEATH.



**WARNING**

INDICATES HAZARDS OR UNSAFE PRACTICES WHICH COULD RESULT IN SEVERE PERSONAL INJURY OR DEATH.



**CAUTION**

INDICATES HAZARDS OR UNSAFE PRACTICES WHICH COULD RESULT IN DAMAGE TO THE MACHINE OR MINOR PERSONAL INJURY.

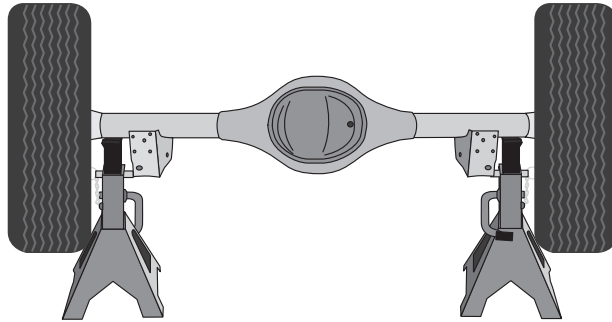
### NOTE

*Indicates a procedure, practice or hint which is important to highlight.*

## C. Installing the LoadLifter 5000 System

### GETTING STARTED

1. Raise the vehicle and support it in a way, using jack stands or equivalent, that the axle can be safely dropped away from the frame. This will need to be done in order for the air spring assembly to be put into position between the axle and frame (Figs. D.1 & D.2). Figure D.2 shows the frame being supported with the vehicle on a drive-on hoist.



*fig. D.1*



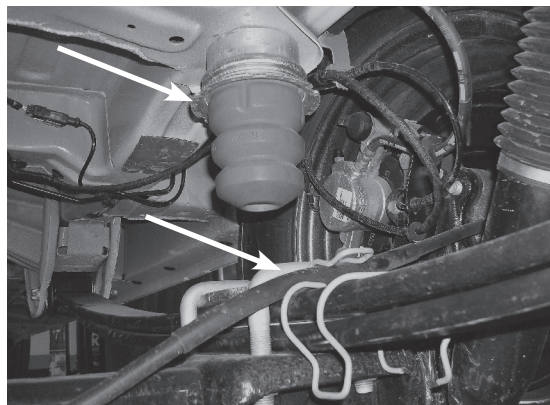
*fig. D.2*

2. Remove the jounce bumper assembly from the frame using a large spanner wrench (Fig. D.3).

#### NOTE

*Use a chisel and hammer to rotate the jounce bumper if a spanner wrench is not available. A large monkey wrench would also work.*

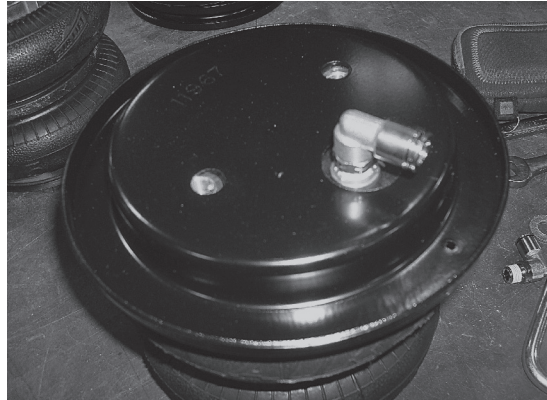
3. Remove the rear spring clips that hold the emergency brake cables onto the spring, rear of the axle (Fig. D.3).



*fig. D.3*

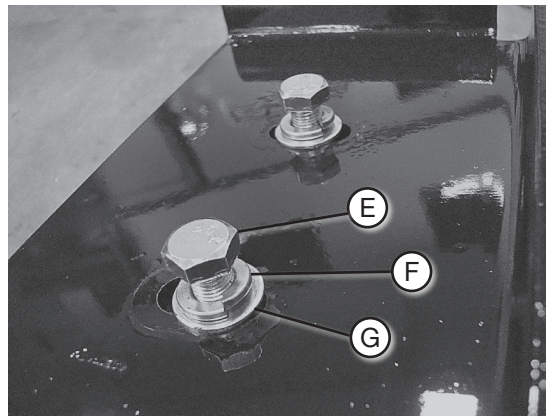
## ASSEMBLING THE AIR SPRING

1. Set a roll plate (D) on top of the air spring (C). The radiused, or rounded, edge of the roll plate will be toward the air spring so that it is seated inside the roll plate (Fig. D.4). Install the 90° swivel fitting (H) into the top of the air spring, finger tight plus 1 1/2 turns.



*fig. D.4*

2. Flip the assembly over and set a roll plate (D) on the bottom of the air spring. Install the lower bracket onto the assembly, making sure the flange of the lower bracket is on the fitting side of the air spring assembly. Attach the lower bracket with two 3/8"-24 x 7/8" hex cap screws (E), 3/8" lock washers (F) and 3/8" flat washers (G) (Fig. D.5). Torque the mounting hardware to no more than 20 lb.-ft. (27 Nm).



*fig. D.5*

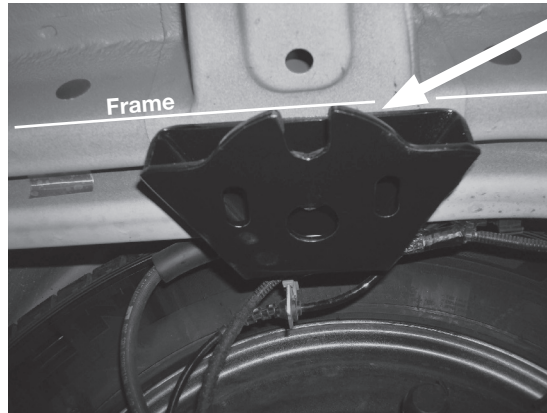
3. Figure D.6 shows both assemblies.



*fig. D.6*

## INSTALLING THE ASSEMBLIES

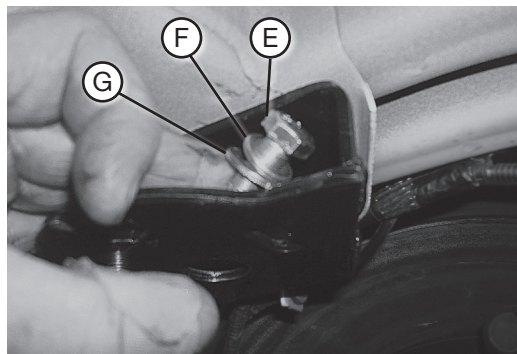
1. Install the upper bracket (A) onto the frame, using the mounting location where the jounce bumper was previously removed, with the M10-1.25 x 30 hex cap screw (J), M10 lock washer (L) and 3/8" flat washer (G) (Fig. 7). Align the bracket so that it is parallel to the frame then torque the hardware to 36 lb.-ft. (50 Nm) (Fig. D.7).



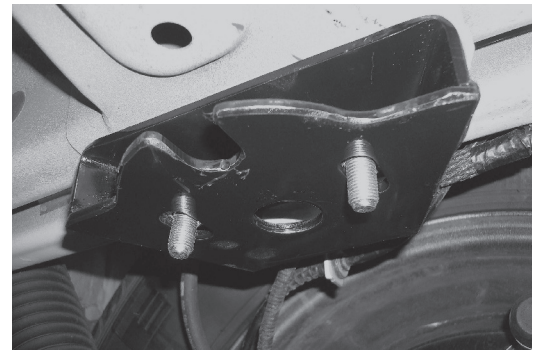
Bracket must be parallel with the frame before tightening.

*fig. D.7*

2. Insert two 3/8"-24 x 7/8" hex head cap screws (E) with two 3/8" lock washers (F) and two 3/8" flat washers (G) into the slots in the upper bracket so they face down (Figs. D.8 & D.9).

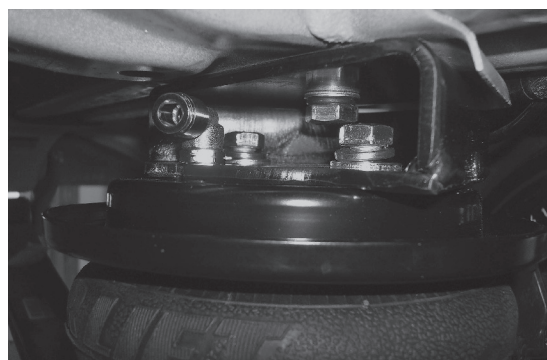


*fig. D.8*



*fig. D.9*

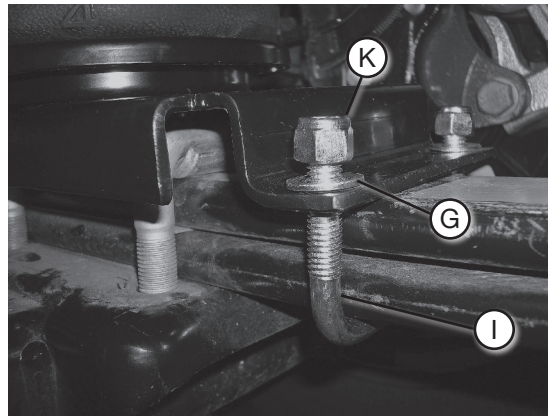
3. Set the assembly onto the leaf springs with the fitting facing inboard. Raise the axle up so that the top of the air spring assembly is just below the upper bracket. Thread the upper hardware through the roll plate and into the upper spring mount, then tighten to finger tight only at this time (Fig. D.10).



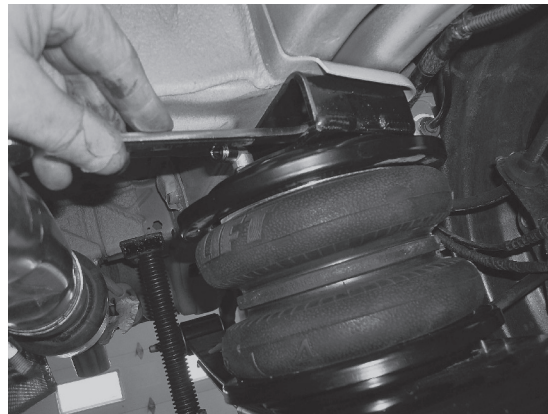
*fig. D.10*



4. Attach the lower bracket to the leaf springs by inserting two U-bolts (I) around the leaf springs and through the lower bracket. Cap with 3/8" flat washers (G) and 3/8" nylon lock nuts (K) (Fig. D.11). Push the assembly back or forward to align the air spring perpendicular to the upper mounting and torque the U-bolt hardware to 16 lb.-ft. (22 Nm).

*fig. D.11*

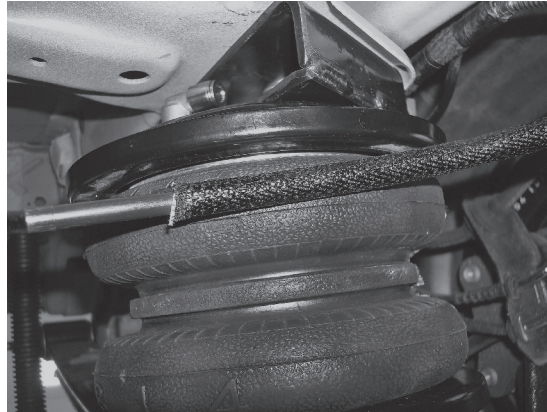
5. Push the top of the air spring assembly in and out to align the air spring perpendicular to the lower bracket, then torque the upper mounting to no more than 20 lb.-ft. (27 Nm) (Fig. D.12).

*fig. D.12*

## E. Installing the Air Lines

This section explains how to set up the air spring kit to be controlled with Schrader valves and a separate compressed air source. An on-board air compressor system allows for hassle-free control of the air springs.

1. On the driver's side hose installation, insert the hose into the hose heat shield, leaving two inches of hose past the shield at this point (Fig. E.1). Once the hose is routed and the valve is installed, trim to length, leaving a little slack, and insert the hose into the fitting at the top of the air spring assembly on the driver side. Once inserted, push the hose heat shield up to the fitting, making sure to completely cover the hose.



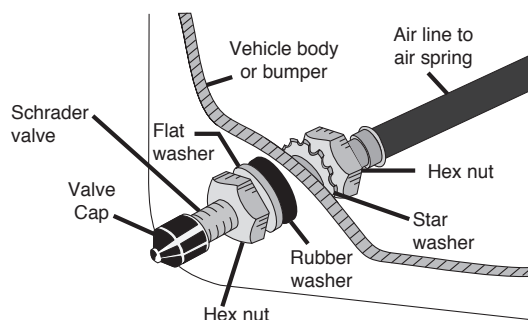
*fig. E.1*

2. Choose a convenient location for mounting the inflation valves. Popular locations for the inflation valve are:
  - a. The wheel well flanges
  - b. The license plate recess in bumper
  - c. Under the gas cap access door
  - d. Through the license plate

### NOTE

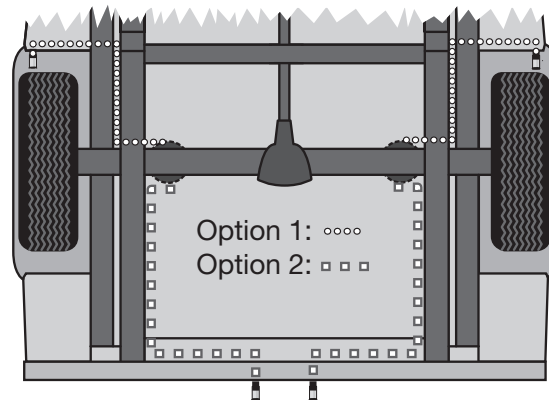
*Whatever the chosen location, make sure there is enough clearance around the inflation valves for an air chuck.*

3. Drill 5/16" holes to install the inflation valves.
4. If installing dual air lines, cut the air line assembly in two equal lengths.
5. Place a 5/16" nut and star washer on the air valve. Leave enough of the inflation valve in front of the nut to extend through the hole and have room for the rubber washer, flat washer, and 5/16" nut and cap. There should be enough valve exposed after installation – approximately 1/2" – to easily apply a pressure gauge or an air chuck (Fig. E.2).



*fig. E.2*

6. Push the inflation valve through the hole and use the rubber washer, flat washer, and another 5/16" nut to secure it in place. Tighten the nuts to secure the assembly.
7. Route the air line along the frame to the fitting on the air spring (Fig. E.3). Keep AT LEAST 6" of clearance between the air line and the exhaust system. Avoid sharp bends and edges. Use plastic tie straps to secure the air line to fixed points along the chassis. Be sure that the tie straps are tight, but do not pinch the air line. Leave at least 2" of slack to allow for any movement that might pull on the air line.

*fig. E.3*

8. Cut off the air line, leaving approximately 12" of extra air line. A clean square cut will prevent leaks. Insert the air line into the air fitting. This is a push-to-connect fitting. Simply push the air line into the 90° swivel fitting until it bottoms out (9/16" of air line should be in the fitting).

### TIPS FOR INSTALLING AIR LINES

When cutting air lines, use a sharp knife or a hose cutter and make clean, square cuts (Fig. E.4). Do not use scissors or wire cutters because these tools may deform the air line, causing it to leak around fittings. Do not cut the lines at an angle.

Do not bend the 1/4" hose at a radius of less than 1" or bend the 3/8" hose at a radius of less than 1 1/2". Do not put side load pressure on fitting. The hose should be straight beyond the fitting for 1" before bending.

Inspect hose for scratches that run lengthwise on hose prior to installation.

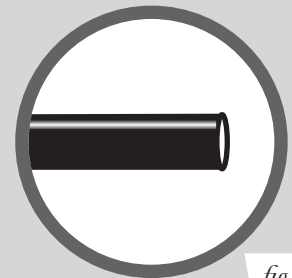


fig. E.4



### INSTALLING THE HEAT SHIELD

1. Bend tabs to provide a dead air space between exhaust pipe and heat shield (Fig. E.5). Attach the heat shield to the exhaust pipe using the clamps. Bend the heat shield for maximum clearance to the air spring. Figure E.6 shows the heat shield installed.

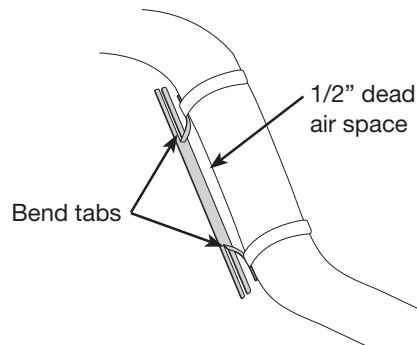


fig. E.5

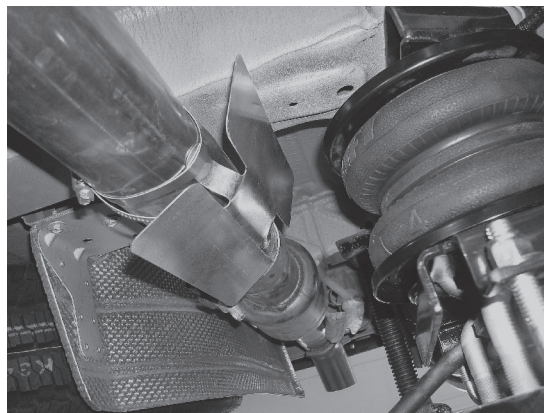
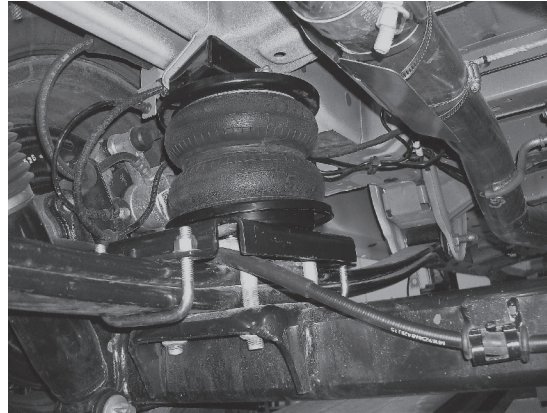


fig. E.6

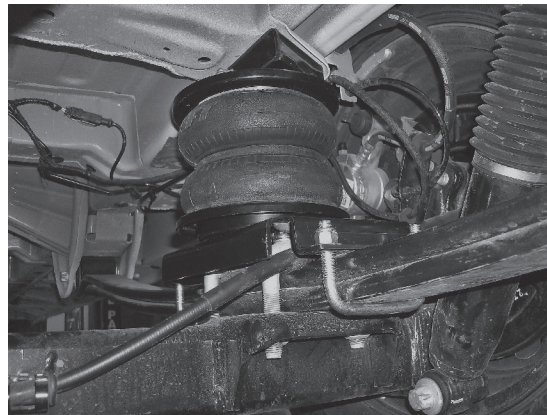
## F. Finished Installation Photos

1. The following images show the finished installation of both sides (Figs. F.1, F.2 & F.3).



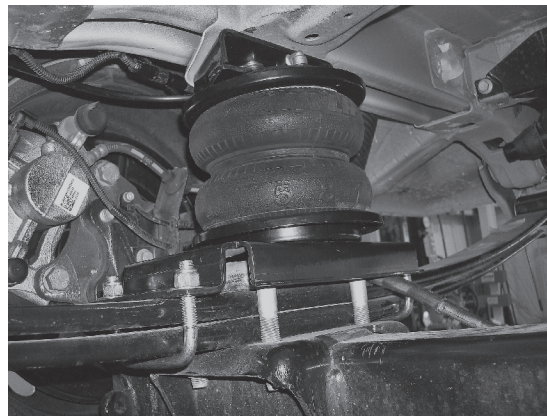
Rear view of the driver's side (left) installation.

*fig. F.1*



Rear view of the passenger's side installation.

*fig. F.2*



Front view of the passenger's side installation.

*fig. F.3*

## G. Before Operating

### CHECKING FOR LEAKS

1. Inflate the air spring to 30 PSI.
2. Spray all connections and the inflation valves with a solution of 1/5 liquid dish soap and 4/5 water. Spot leaks easily by looking for bubbles in the soapy water.
3. After the test, deflate the springs to the minimum pressure required to restore the system to normal ride height. Do not deflate to lower than 5 PSI.
4. Check the air pressure again after 24 hours. A 2-4 PSI loss after initial installation is normal. Retest for leaks if the loss is more than 5 PSI.

### FIXING LEAKS

1. If there is a problem with the swivel fitting:
  - a. Check the air line connection by deflating the spring and removing the line by pulling the collar against the fitting and pulling firmly on the air line. Trim 1" off the end of the air line. Be sure the cut is clean and square (Fig. E.4). Reinsert the air line into the push-to-connect fitting.
  - b. Check the threaded connection by tightening the swivel fitting another half turn. If it still leaks, deflate the air spring, remove the fitting, and re-coat the threads with thread sealant. Reinstall by hand tightening as much as possible and then use a wrench for an additional two turns.
2. If there is a problem with the inflation valve:
  - a. Check the valve core by tightening it with a valve core tool.
  - b. Check the air line by removing the air line from the barbed type fitting. Cut the air line off a few inches in front of the fitting and use a pair of pliers or vice grips to pull/twist the air line off of the fitting.



#### **CAUTION**

DO NOT CUT OFF THE AIR LINE COMPLETELY AS THIS WILL USUALLY NICK THE BARB AND RENDER THE FITTING USELESS.

## INSTALLATION CHECKLIST

- Clearance test** — Inflate the air springs to 75-90 PSI and make sure there is at least 1/2" clearance from anything that might rub against each sleeve. Be sure to check the tire, brakes, frame, shock absorbers and brake cables.
  
- Leak test before road test** — Inflate the air springs to 75-90 PSI and check all connections for leaks. All leaks must be eliminated before the vehicle is road tested.
  
- Heat test** — Be sure there is sufficient clearance from heat sources, at least 6" for air springs and air lines. If a heat shield was included in the kit, install it.
  
- Fastener test** — Recheck all bolts for proper torque.
  
- Road test** — The vehicle should be road tested after the preceding tests. Inflate the springs to recommended driving pressures. Drive the vehicle 10 miles and recheck for clearance, loose fasteners and air leaks.
  
- Operating instructions** — If professionally installed, the installer should review the operating instructions with the owner. Be sure to provide the owner with all of the paperwork that came with the kit.

## POST-INSTALLATION CHECKLIST

- Overnight leak down test** — Recheck air pressure after the vehicle has been used for 24 hours. If the pressure has dropped more than 5 PSI, then there is a leak that must be fixed. Either fix the leak yourself or return to the installer for service.
  
- Air pressure requirements** — It is important to understand the air pressure requirements of the air spring system. Regardless of load, the air pressure should always be adjusted to maintain adequate ride height at all times while driving.
  
- Thirty-day or 500-mile test** — Recheck the air spring system after 30 days or 500 miles, whichever comes first. If any part shows signs of rubbing or abrasion, the source should be identified and moved, if possible. If it is not possible to relocate the cause of the abrasion, the air spring may need to be remounted. If professionally installed, the installer should be consulted. Check all fasteners for tightness.

# H. Product Use, Maintenance and Servicing

Minimum Recommended Pressure	Maximum Air Pressure
5 PSI	100 PSI

## MAINTENANCE GUIDELINES

**NOTE**

*By following the steps below, vehicle owners will obtain the longest life and best results from their air springs.*



**CAUTION**

1. Check air pressure weekly.
  2. Always maintain normal ride height. Never inflate beyond 100 PSI.
  3. If you develop an air leak in the system, use a soapy water solution (1/5 liquid dish soap and 4/5 water) to check all air line connections and the inflation valve core before deflating and removing the air spring.
- FOR SAFETY AND TO PREVENT POSSIBLE DAMAGE TO THE VEHICLE, DO NOT EXCEED MAXIMUM GROSS VEHICLE WEIGHT RATING (GVWR), AS INDICATED BY THE VEHICLE MANUFACTURER. ALTHOUGH THE AIR SPRINGS ARE RATED AT A MAXIMUM INFLATION PRESSURE OF 100 PSI, THE AIR PRESSURE ACTUALLY NEEDED IS DEPENDENT ON LOAD AND GVWR.
4. Loaded vehicles require at least 25 PSI. A “loaded vehicle” refers to a vehicle with a heavy bed load, a trailer or both. Never exceed GVWR, regardless of air spring, air pressure or other load assist. The springs in this kit will support approximately 40 pounds of load (combined on both springs) for each 1 PSI of pressure. The required air pressure will vary depending on the state of the original suspension. Operating the vehicle below the minimum air spring pressure will void the Air Lift warranty.
  5. When increasing load, always adjust air pressure to maintain normal ride height. Increase or decrease pressure from the system as necessary to attain normal ride height for optimal ride and handling. Remember that loads carried behind the axle (including tongue loads) require more leveling force (pressure) than those carried directly over the axle.
  6. Always add air to springs in small quantities, checking the pressure frequently.
  7. Should it become necessary to raise the vehicle by the frame, make sure the system is at minimum pressure (5 PSI) to reduce the tension on the suspension/ brake components. Use of on-board leveling systems do not require deflation or disconnection.
  8. Periodically check the air spring system fasteners for tightness. Also, check the air springs for any signs of rubbing. Realign if necessary.
  9. On occasion, give the air springs a hard spray with a garden hose to remove mud, sand, gravel or other debris.



## TUNING THE AIR PRESSURE

Pressure determination comes down to three things — level vehicle, ride comfort and stability.

### 1. Level vehicle

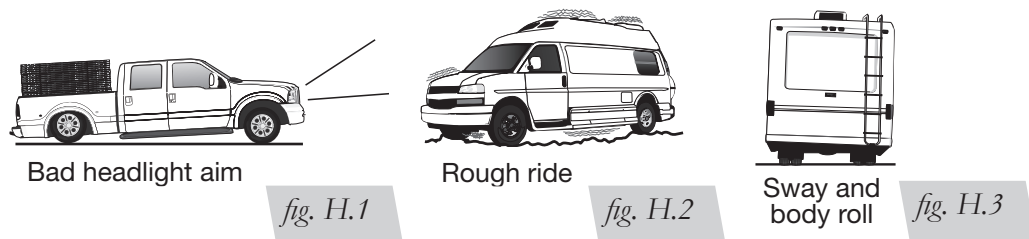
If the vehicle's headlights are shining into the trees or the vehicle is leaning to one side, then it is not level (Fig. H.1). Raise the air pressure to correct either of these problems and level the vehicle.

### 2. Ride comfort

If the vehicle has a rough or harsh ride it may be due to either too much pressure or not enough (Fig. H.2). Try different pressures to determine the best ride comfort.

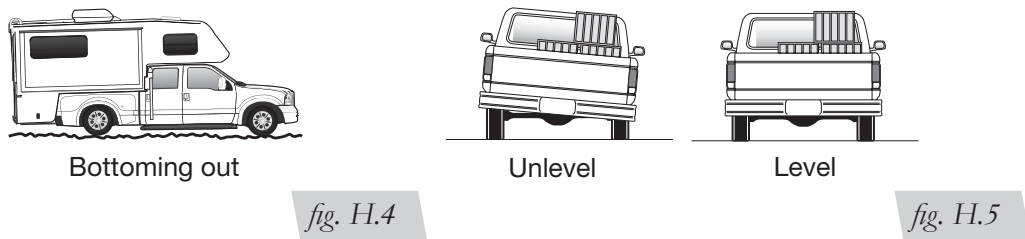
### 3. Stability

Stability translates into safety and should be the priority, meaning the driver may need to sacrifice a perfectly level and comfortable ride. Stability issues include roll control, bounce, dive during braking and sponginess (Fig. H.3). Tuning out these problems usually requires an increase in pressure.



## GUIDELINES FOR ADDING AIR

1. Start with the vehicle level or slightly above.
2. When in doubt, always add air.
3. If the front of the vehicle dives while braking, increase the pressure in the front air bags, if equipped.
4. If it is ever suspected that the air bags have bottomed out, increase the pressure. (Fig. H.4)
5. Adjust the pressure up and down to find the best ride.
6. If the vehicle rocks and rolls, adjust the air pressure to reduce movement.
7. It may be necessary to maintain different pressures on each side of the vehicle. Loads such as water, fuel, and appliances will cause the vehicle to be heavier on one side (Fig. H.5). As much as a 50 PSI difference is not uncommon.



# I. Frequently Asked Questions

**Q. The system won't maintain pressure overnight. What could be wrong?**

One of the air lines may be improperly installed or a line may have a hole or crack. Start by leak testing the air line connections. If no leaks are found, look for leaks in the rest of the air lines. Follow the steps in "Fixing Leaks."

**Q. One of the corners won't rise.**

Look for a kink or fold in the air line going to that air spring. Replace any line that has been kinked.

**Q. Will installing air springs increase the weight ratings of a vehicle?**

No. Adding air springs will not change the weight ratings (GAWR, GCWR and/or GVWR) of a vehicle. Exceeding the GVWR is dangerous and voids the Air Lift warranty.

**Q. Is it necessary to keep air in the air springs at all times and how much pressure will they need?**

For LoadLifter 5000 Ultimate, the recommended minimum air pressure is 5 PSI, but it can safely be run at zero air pressure.

**Q. Is it necessary to add a compressor system to the air springs?**

No. Air pressure can be adjusted with any type of compressor as long as it can produce sufficient pressure to service the springs. Even a bicycle tire pump can be used, but it's a lot of work.

**Q. How long should air springs last?**

If the air springs are properly installed and maintained they can last indefinitely.

**Q. Will raising the vehicle on a hoist for service work damage the air springs?**

No. The vehicle can be lifted on a hoist for short-term service work such as tire rotation or oil changes. However, if the vehicle will be on the hoist for a prolonged period of time, support the axle with jack stands in order to take the tension off of the air springs.



# Limited Warranty and Return Policy

## WHAT THIS WARRANTY COVERS

Air Lift Company provides a warranty to the original purchaser of its Load Support Products, for the periods of time listed below, by product line, from the date of original purchase, that the products will be free from defects in workmanship and materials when used on cars and trucks as specified by Air Lift Company and under normal operating conditions, subject to the requirements and exclusions set forth below.

## WHAT THIS WARRANTY DOES NOT COVER

The warranty does not apply to products that have been improperly applied, improperly installed, or which have not been maintained in accordance with installation instructions furnished with all products. This warranty does not apply and is void if damage or failure is caused by: accident, abuse, misuse (including but not limited to racing or off-road activities or commercial use), abnormal use, faulty installation, liquid contact, fire, earthquake or other external cause; operating the product outside Air Lift Company’s instructions, specifications or guidelines; or service, alteration, maintenance or repairs performed by anyone other than Air Lift Company to the product from its purchased condition. This warranty also does not apply to: consumable parts, such as batteries; cosmetic damage, including but not limited to scratches or dents; defects caused by normal wear and tear or otherwise due to the normal aging of the product, or if any serial or identification number has been removed or defaced from the product. Air Lift Company reserves the right to change the design of any product without assuming any obligation to modify any product previously manufactured.

## LIMITATION OF LIABILITY

To the extent permitted by law, this warranty and the remedies set forth herein are exclusive and in lieu of all other warranties, remedies and conditions, whether oral, written, statutory, express or implied. AIR LIFT COMPANY DISCLAIMS ALL STATUTORY AND IMPLIED WARRANTIES, INCLUDING WITHOUT LIMITATION, WARRANTIES OF MERCHANTABILITY AND FITNESS FOR A PARTICULAR PURPOSE AND WARRANTIES AGAINST HIDDEN OR LATENT DEFECTS TO THE EXTENT PERMITTED BY LAW. To the extent such warranties cannot be disclaimed, such implied warranties shall apply only for the warranty period specified above. Please note that some states do not allow limitation on how long an implied warranty (or condition) lasts. So the above limitation may not apply to you.

Except as provided in this warranty and to the extent permitted by law, Air Lift Company shall not be liable for any direct, special, incidental or consequential damages resulting from any breach of warranty or condition, or arising in connection with the sale, use or repair of air lift products, or under any other legal theory, including but not limited to loss of use, loss of revenue, loss of actual or anticipated profits, loss of the use of money, loss of business, loss of opportunity, loss of goodwill, and loss of reputation. Air Lift Company’s maximum liability shall not in any case exceed the purchase price paid by you for the Air Lift product. Please note that some states do not allow the exclusion or limitation of incidental or consequential damages, so the above limitation or exclusion may not apply to you.

## HOW TO GET SERVICE

If a defect in workmanship or materials causes your Air Lift product to become inoperable within the warranty period, before returning any defective product. The consumer shall be responsible for removing (labor charges) the defective product from the vehicle and returning it, shipping costs prepaid, to Air Lift Company for verification. You must prove to the satisfaction of Air Lift Company the date of original purchase of your Air Lift product. You must also enclose the RMA number and a return address. A minimum shipping and handling charge will apply to all warranty claims. You must also pack the product to minimize the risk of it being damaged in transit. If we receive a product in damaged condition as the result of shipping, we will notify you and you must seek a claim with the shipper.

## WHAT AIR LIFT COMPANY WILL DO

If you submit a valid claim to Air Lift Company during the warranty period, Air Lift Company will, at its option, repair your Air Lift product or furnish you with a new or rebuilt product. Air Lift Company will not reimburse you for repairs or replacement parts provided by other parties. Your repaired or replacement Air Lift product will be returned to you (subject to payment of the required warranty claim shipping and handling charge) and it will be covered under the warranty for the balance of the warranty period, if any. When a product or part is replaced, any replacement item becomes your property and the replaced item becomes property of Air Lift Company. You are responsible for installation/reinstallation (labor charges) of the product.

## HOW THE LAW RELATES TO THIS WARRANTY

This warranty gives you specific legal rights and you may also have other rights which vary from state to state. By this warranty, Air Lift Company does not limit or exclude your rights except as allowed by law. To fully understand your rights, you should consult the laws of your state.

## SPECIFIC LOAD SUPPORT WARRANTY PERIODS BY PRODUCT LINE

LoadLifter 5000™ Ultimate .....	Lifetime Limited	WirelessAIR™ .....	2 Year Limited
LoadLifter 5000™ .....	Lifetime Limited	WirelessONE™ .....	2 Year Limited
RideControl™ .....	Lifetime Limited	LoadController™ Single and Dual.....	2 Year Limited
Air Lift 1000™ .....	Lifetime Limited	LoadController™ I and II .....	2 Year Limited
AirCell™ .....	Lifetime Limited	SmartAir™ II .....	2 Year Limited
SlamAir™ .....	Lifetime Limited	Other Accessories.....	2 Year Limited

---

## Replacement Part Information

If replacement parts are needed, contact the local dealer or call Air Lift customer service. Most parts are immediately available and can be shipped the same day. **Contact Air**

**Lift Company customer service first if:**

- Parts are missing from the kit.
- Need technical assistance on installation or operation.
- Broken or defective parts in the kit.
- Wrong parts in the kit.
- Have a warranty claim or question.

**Contact the retailer where the kit was purchased:**

- If it is necessary to return or exchange the kit for any reason.
- If there is a problem with shipping if shipped from the retailer.
- If there is a problem with the price.