

# LoadLIFTER™ 5000

by AIR LIFT®

# Kit 57213 Ford Transit



## INSTALLATION GUIDE

For maximum effectiveness and safety, please read these instructions completely before proceeding with installation.

*Failure to read these instructions can result in an incorrect installation.*

# TABLE OF CONTENTS

|  |           |
|--|-----------|
| <b>Introduction</b> .....  | <b>2</b>  |
| Important Safety Notice .....  | 2         |
| Notation Explanation .....   | 2         |
| <b>Installation Diagram</b> .....  | <b>3</b>  |
| Hardware List .....  | 4         |
| Tools List .....   | 4         |
| <b>Installing the LoadLifter 5000 System</b> .....                             | <b>5</b>  |
| Getting Started .....  | 5         |
| Assembling the Air Springs .....   | 7         |
| Installing the Air Spring Assemblies .....                                     | 9         |
| ABS Line Adjustment on Left (Driver) Side .....                                | 11        |
| Installing the Air Lines .....   | 12        |
| Installing the Heat Shield .....   | 14        |
| Checking for Leaks .....   | 15        |
| Fixing Leaks .....   | 15        |
| Photos of Finished Assemblies .....  | 16        |
| <b>Before Operating</b> .....  | <b>17</b> |
| Installation Checklist .....   | 17        |
| Post-Installation Checklist .....  | 17        |
| <b>Product Use, Maintenance and Servicing</b> .....                            | <b>18</b> |
| Minimum and Maximum Pressure .....   | 18        |
| Maintenance Guidelines .....   | 18        |
| Troubleshooting Guide .....  | 18        |
| Frequently Asked Questions .....   | 19        |
| Tuning the Air Pressure .....  | 19        |
| Guidelines for Adding Air .....  | 20        |
| <b>Choosing the Right On-Board <a href="#">Air Compressor System</a></b> ..... | <b>21</b> |
| <b>Warranty and Returns Policy</b> .....                                       | <b>22</b> |
| <b>Replacement Information</b> .....   | <b>23</b> |
| <b>Contact Information</b> .....   | <b>23</b> |

# Introduction

The purpose of this publication is to assist with the installation, maintenance and troubleshooting of the LoadLifter 5000 air spring kit. LoadLifter 5000 utilizes sturdy, reinforced, commercial-grade single- or double-bellows (depending on the kit). The bellows are manufactured like a tire with layers of rubber and cords that control growth. LoadLifter 5000 kits are recommended for most 3/4 and 1 ton pickups and SUVs with leaf springs, and provide up to 5,000 pounds of load-leveling support with air adjustability from 5-100 PSI. The kits are also used in motor home rear kits and some motor home fronts where leaf spring are used.

It is important to read and understand the entire installation guide before beginning installation or performing any maintenance, service or repair. The information here includes a hardware list, tool list, step-by-step installation information, maintenance guidelines and operating tips.

## IMPORTANT SAFETY NOTICE

The installation of this kit does not alter the Gross Vehicle Weight Rating (GVWR) or payload of the vehicle. Check your vehicle's owner's manual and do not exceed the maximum load listed for your vehicle.

**Gross Vehicle Weight Rating:** The maximum allowable weight of the fully loaded vehicle (including passengers and cargo). This number — along with other weight limits, as well as tire, rim size and inflation pressure data — is shown on the vehicle's Safety Compliance Certification Label.

**Payload:** The combined, maximum allowable weight of cargo and passengers that the truck is designed to carry. Payload is GVWR minus the Base Curb Weight.

## NOTATION EXPLANATION

Hazard notations appear in various locations in this publication. Information which is highlighted by one of these notations must be observed to help minimize risk of personal injury or possible improper installation which may render the vehicle unsafe. Notes are used to help emphasize areas of procedural importance and provide helpful suggestions. The following definitions explain the use of these notations as they appear throughout this guide.

INDICATES IMMEDIATE HAZARDS WHICH WILL RESULT IN SEVERE PERSONAL INJURY OR DEATH.

 **DANGER**

INDICATES HAZARDS OR UNSAFE PRACTICES WHICH COULD RESULT IN SEVERE PERSONAL INJURY OR DEATH.

 **WARNING**

INDICATES HAZARDS OR UNSAFE PRACTICES WHICH COULD RESULT IN DAMAGE TO THE MACHINE OR MINOR PERSONAL INJURY.

 **CAUTION**

## NOTE

*Indicates a procedure, practice or hint which is important to highlight.*

# Installation Diagram

The P-clamp shown here is in the right (passenger) side position on the upper bracket.

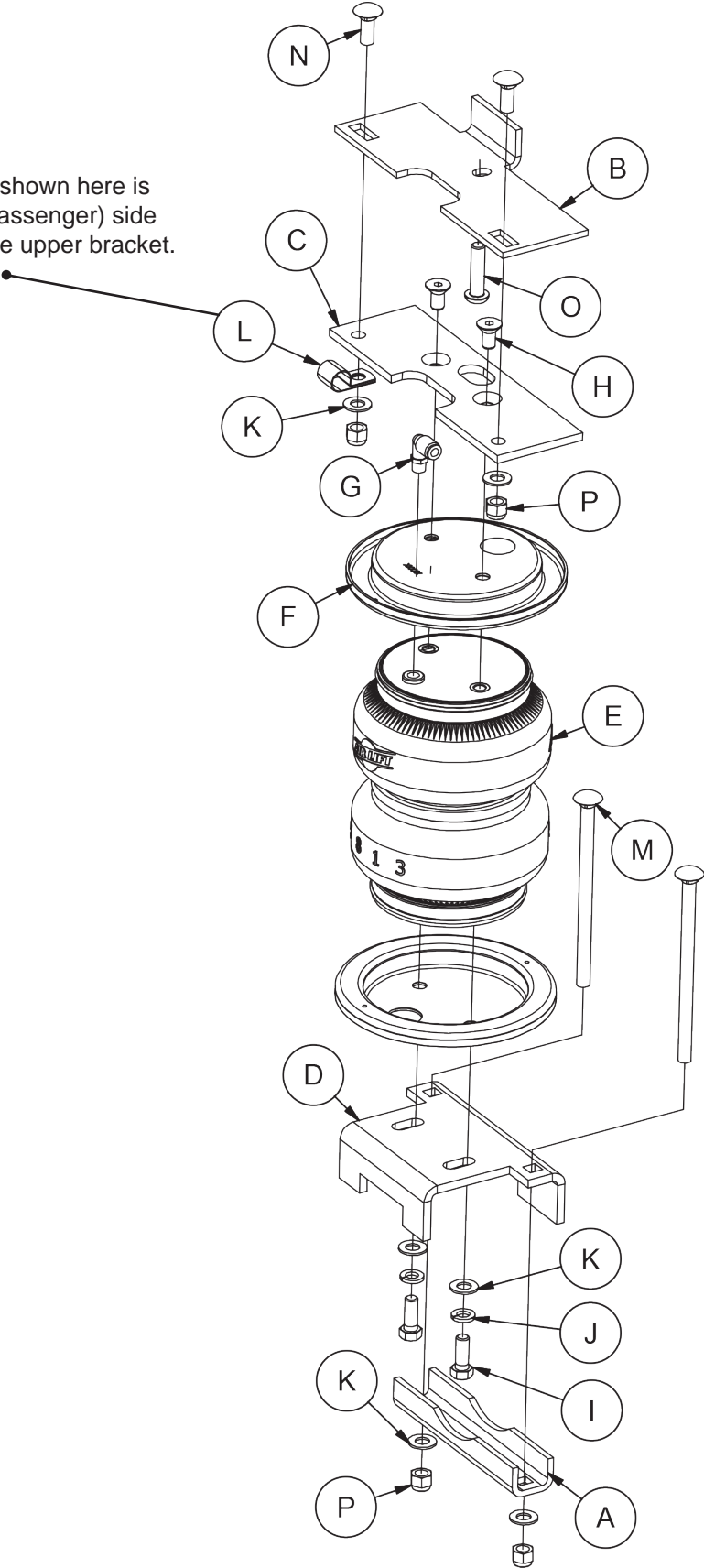

fig. 1

# Hardware and Tools Lists

## HARDWARE LIST

| Item | Part # | Description.....Qty                   | Item | Part # | Description.....Qty                   |
|------|--------|---------------------------------------|------|--------|---------------------------------------|
| A    | 01531  | Clamp bar .....2                      | M    | 17133  | 3/8"-16 x 6" Carriage Bolt.....4      |
| B    | 07954  | Frame bracket.....2                   | N    | 17361  | 3/8"-16 x 1.25" Carriage Bolt.....4   |
| C    | 07956  | Bellows bracket.....2                 | O    | 17366  | M10-150 X 35 button head screw .....2 |
| D    | 03906  | Lower bracket .....2                  | P    | 18435  | 3/8" nyloc nut .....8                 |
| E    | 58437  | Air spring.....2                      | AA*  | 20086  | Air line assembly.....1               |
| F    | 11951  | Roll plate .....4                     | BB*  | 10466  | Tie strap .....6                      |
| G    | 21848  | 90° swivel fitting .....2             | CC*  | 21230  | Valve cap .....2                      |
| H    | 17215  | 3/8"-24 x 7/8" flat head screw .....4 | DD*  | 18501  | 5/16" flat washer .....2              |
| I    | 17203  | 3/8"-24 x 7/8" hex cap screw.....4    | EE*  | 21234  | Rubber washer.....2                   |
| J    | 18427  | 3/8" lock washer.....4                | FF*  | 18401  | Star washer.....2                     |
| K    | 18444  | 3/8" flat washer .....12              | GG*  | 21233  | 5/16" hex nut.....4                   |
| L    | 10778  | P clamp.....2                         |      |        |                                       |

\*Not shown in fig. 1.

## TOOLS LIST

| Description..... Qty                    | Description..... Qty                               |
|---|--|
| Hoist or floor jacks ..... 1            | #6 allen wrench (socket if available)..... 1       |
| Safety stands..... 2                    | 7/32" allen wrench (socket if available) ..... 1   |
| Safety glasses ..... 1                  | 5/16" drill bit (very sharp)..... 1                |
| Torque wrench..... 1                    | Heavy duty drill..... 1                            |
| Standard open-end combo wrenches..... 1 | Hose cutter, razor blade, or sharp knife ..... 1   |
| Medium size crescent wrench ..... 1     | Air compressor or compressed air source..... 1     |
| Ratchet ..... 1                         | Spray bottle with dish soap/water solution ..... 1 |
| Metric and standard sockets..... 1      |  |

# Installing the LoadLifter 5000 System

## GETTING STARTED

**⚠ DANGER**

COMPRESSED AIR CAN CAUSE INJURY AND DAMAGE TO THE VEHICLE AND PARTS IF IT IS NOT HANDLED PROPERLY. FOR YOUR SAFETY, DO NOT TRY TO INFLATE THE AIR SPRINGS UNTIL THEY HAVE BEEN PROPERLY SECURED TO THE VEHICLE.

1. Raise the vehicle and support it, using jack stands or equivalent, so that the axle can be safely dropped away from the frame. This will need to be done in order for the air spring assembly to be positioned between the axle and frame. Figure 2 shows the frame being supported with the vehicle on a drive-on hoist.

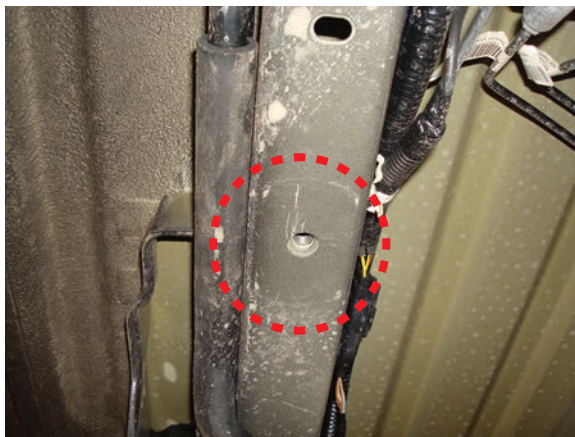

*fig. 2*

2. Unbolt and remove the stock jounce bumpers from under the frame rails on both sides (figs. 3 and 4). This is a necessary step to install the kit.



*fig. 3*



Driver side shown with jounce bumper removed.

*fig. 4*

1. Insert two 3/8-16 X 1.25" carriage bolts (N) through the frame bracket (B). The heads of the bolts should be on the flange side of the bracket (fig. 5).

fig. 5

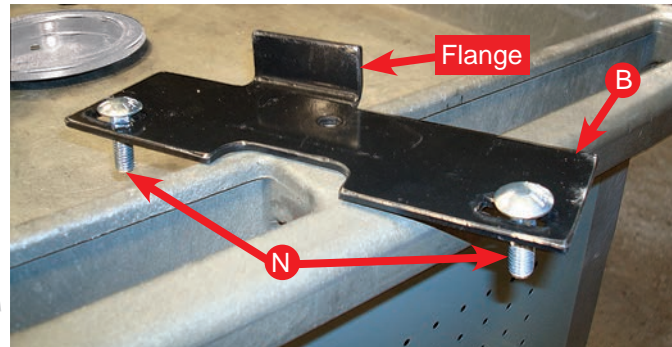

2. Install the upper frame bracket assembly onto the frame using the M10-150 X 35 button head screw (O) making sure the flange on the bracket is on the inside of the frame rail and pointing up (figs. 6 and 7). Push the flange on the bracket up against the frame and torque screw to 30 ft-lbs.

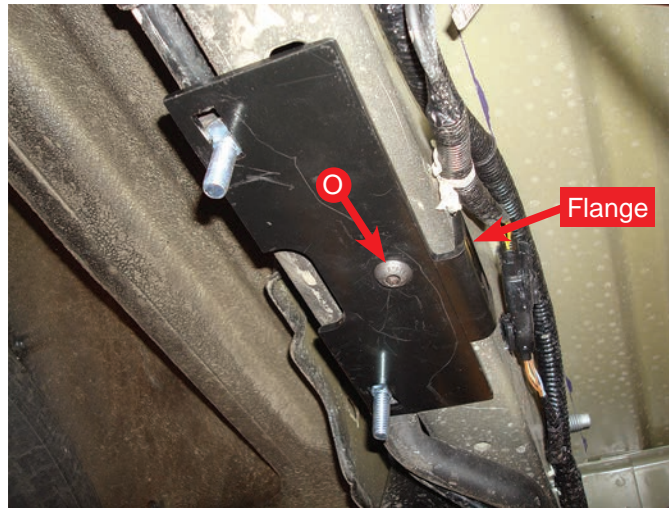

Left (driver) side shown.

fig. 6

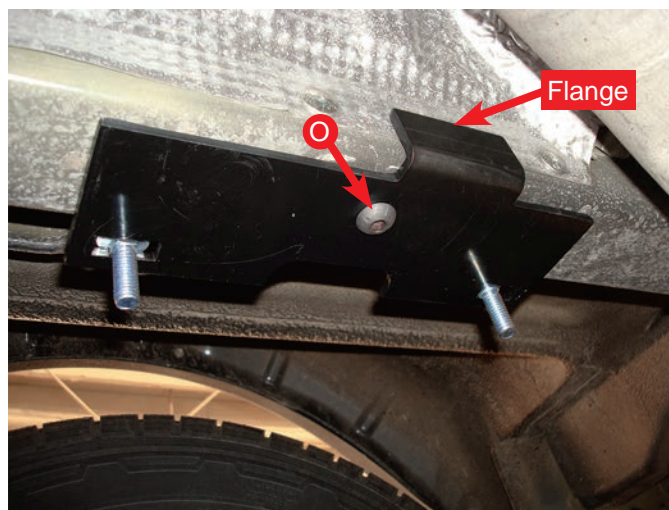

Right (passenger) side shown.

fig. 7

## ASSEMBLING THE AIR SPRINGS

1. Set a roll plate (F) over the top of the bellows (E) (fig. 8).

**NOTE**

*The radius (rounded) edge of the roll plate (F) will be towards the air spring, so that the air spring is seated inside both roll plates.*

2. Install the 90° swivel fitting (G) into the top of the bellows, finger-tight plus one and a half turns.

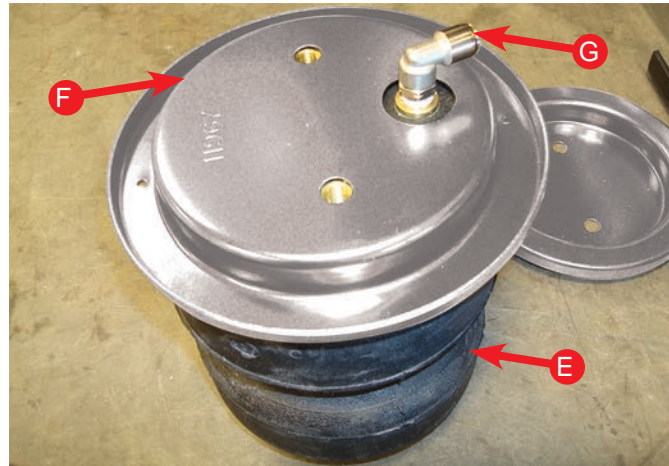

fig. 8

3. Set the bellows bracket (C) over the bellows and roll plate and attach with the 3/8-24 X 7/8" flat head screws (H) (fig. 9). Torque to no more than 20 ft-lbs. Repeat for the other bellows.

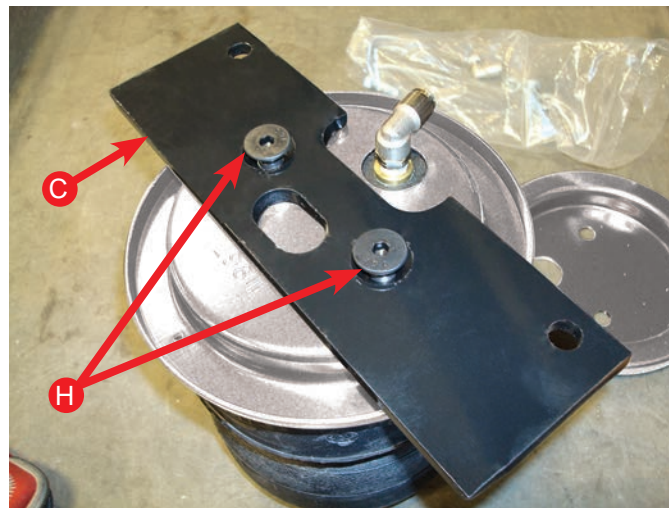
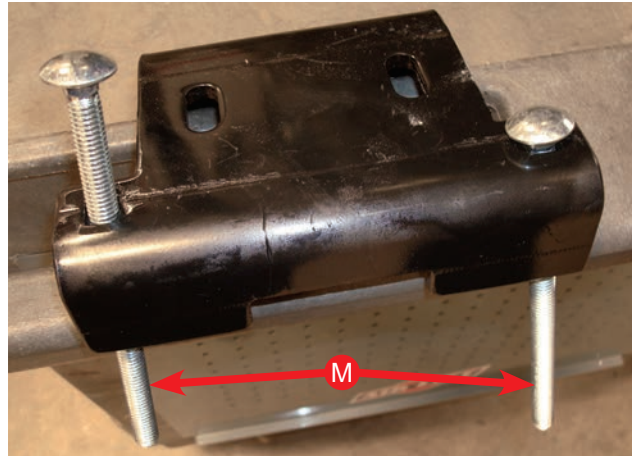

fig. 9



1. Insert two 3/8-13 X 6" carriage bolts (M) through the lower bracket (fig. 10). Assemble the lower bracket onto the air spring assembly so the carriage bolts are on the opposite side of the fittings (fig 11). Leave them loose at this time. Attach the lower bracket to the air spring assembly with two 3/8-24 X 7/8" hex cap screws (I), two 3/8" lock washers (J) and two 3/8" flat washers (K) (fig 12). Leave loose at this time.

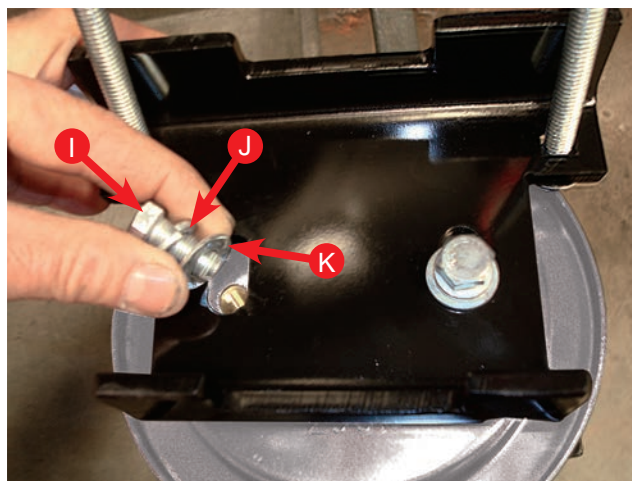

*fig. 10*



Attach the lower brackets so the carriage bolts are opposite of the fitting on the air spring assembly.

*fig. 11*



*fig. 12*

## INSTALLING THE AIR SPRING ASSEMBLIES

1. If not already done, lower the axle enough for clearance to install the assemblies into position.
2. Set the left (driver) and right (passenger) side assemblies into position making sure that the long carriage bolt in the rear of the lower bracket, fits between the brake/ABS lines and the axle (fig. 13).

### NOTE

*The lower bracket will be nested over the jounce bumper strike plate.*



Left side shown: set one of the assemblies into position making sure that the carriage bolt goes in between the brake/ABS lines and the axle as shown.

*fig. 13*

3. Raise the axle or lower the body of the vehicle making sure that the carriage bolts — previously installed in the frame bracket — nests into the holes of the bellows bracket (fig. 14). On the back carriage bolts only, it will be necessary to install the P clamps (L) on both sides of the assemblies (the left (driver) and right (passenger)). Cap all the carriage bolts with 3/8" flat washers (K) and a 3/8" nyloc nut (P). Leave them loose at this time.

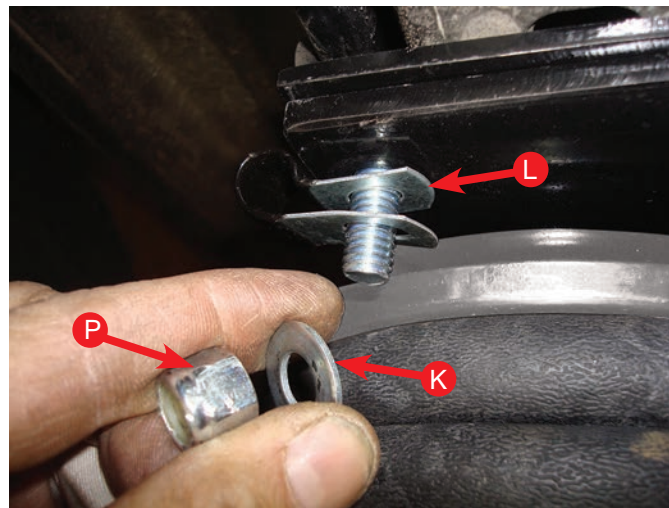

*fig. 14*

1. Set the axle clamp bar (A) over the long carriage bolts onto the lower bracket, under the axle and cap with two 3/8" flat washers (K) and a 3/8" nyloc nut (P) (fig. 15). Leave loose at this time.

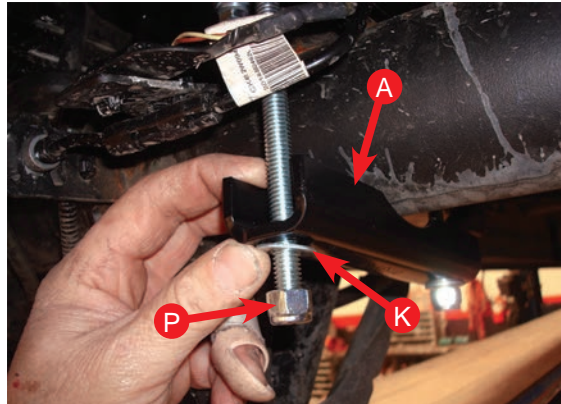

fig. 15

2. The bellows bracket is slotted so that it can be adjusted forward or rearward. Move the bellows assembly so that the bellows is parallel to the upper and lower bracket. Torque the upper hardware to 15 ft-lbs.
3. Once the lower bracket (D) is parallel to the upper bracket, the axle clamp bar (A) on the lower bracket can be torqued evenly to 10 ft-lbs (fig. 16).

## NOTE

*It may be necessary to pull the brake line away from the carriage bolt slightly on the right hand side to gain clearance so the line will not rub on the bolt.*

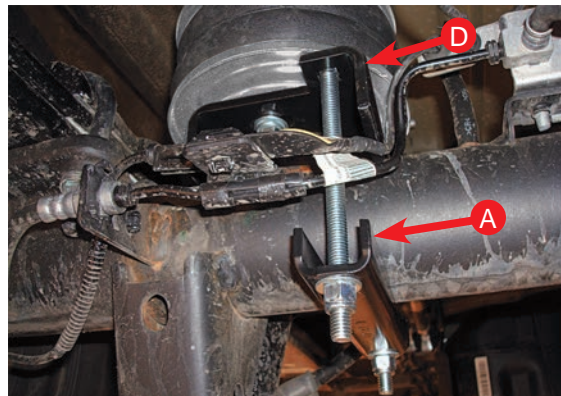

fig. 16

4. Once the upper and lower brackets are tight, it will be necessary to tighten the lower bellows mounting hardware on the lower brackets. Slide the bellows along the slots of the lower bracket for the final alignment of the air spring and torque the lower mounting hardware to no more than 20 ft-lbs (fig. 17).

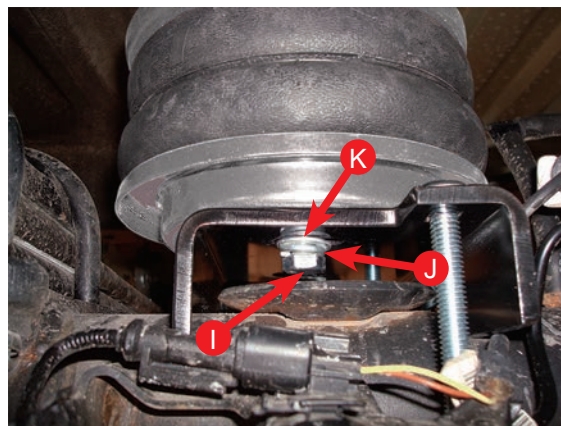
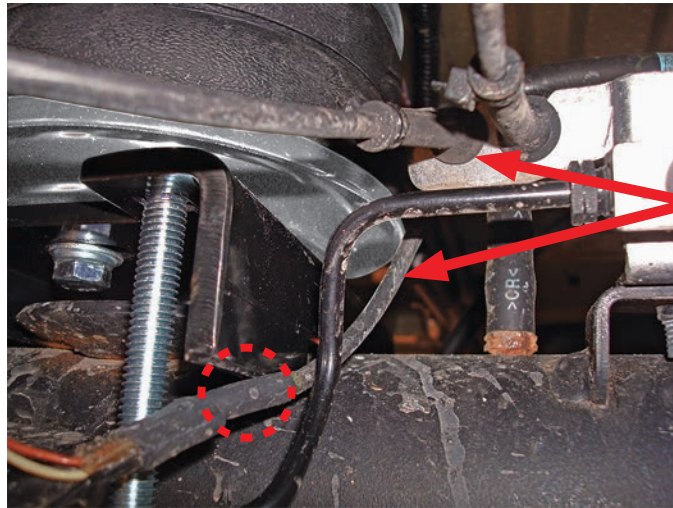

fig. 17

## ABS LINE ADJUSTMENT ON LEFT (DRIVER) SIDE

1. On the driver side behind the axle, the ABS line will need to be adjusted so that it will not rub on the lower bracket (fig. 18).



The ABS line on the left (driver) side will need to be moved so that it does not rub on the lower bracket.

*fig. 18*

2. To do this just pull the line out of the holder on the axle and rotate it 180°, then push it back into the holder (fig. 19). This will change the position of the line so that it will not come in contact with the lower bracket.

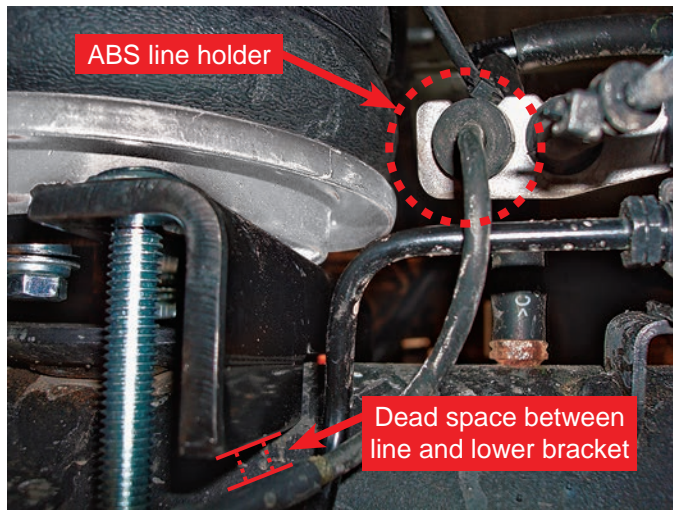

*fig. 19*

## INSTALLING THE AIR LINES

1. Choose a convenient location for mounting the inflation valves. Popular locations for the inflation valve are:
  - a. The wheel well flanges.
  - b. License plate recess in bumper.
  - c. Under the gas cap access door.
  - d. Through license plate itself.

### NOTE

*What ever the chosen location is, make sure there is enough clearance around the inflation valves for an air chuck.*

2. Drill a 5/16" hole to install the inflation valves.
3. Cut the air line assembly (AA) in two equal lengths.

### CAUTION

WHEN CUTTING OR TRIMMING THE AIR LINE, USE A HOSE CUTTER, A RAZOR BLADE OR A SHARP KNIFE. A CLEAN, SQUARE CUT WILL PREVENT LEAKS. DO NOT USE WIRE CUTTERS OR SCISSORS TO CUT THE AIR LINE. THESE TOOLS MAY FLATTEN OR CRIMP THE AIR LINE, CAUSING IT TO LEAK AROUND THE O-RING SEAL INSIDE THE ELBOW FITTING (FIG. 20).

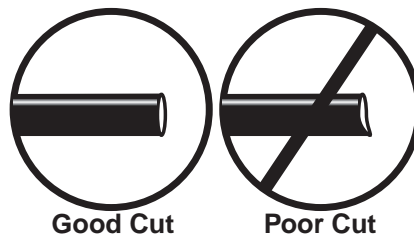

fig. 20

4. Place a 5/16" hex nut (GG) and a star washer (FF) on the air valve. Leave enough of the inflation valve in front of the nut to extend through the hole and have room for the rubber washer (EE), flat washer (DD), and 5/16" hex nut (GG) and valve cap (CC). There should be enough valve exposed after installation - approximately 1/2" - to easily apply a pressure gauge or an air chuck (fig. 21).
5. Push the inflation valve through the hole and use the rubber washer (EE), flat washer (DD), and another 5/16" hex nut (GG). Tighten the nuts to secure the assembly in place (fig. 32).

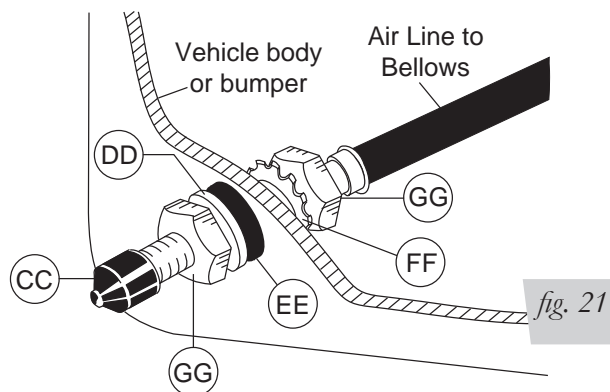

fig. 21

8. Route the air line along the frame to the air fitting on the air spring (fig. 22). Keep AT LEAST 6" of clearance between the air line and heat sources, such as the exhaust pipes, muffler, or catalytic converter. Avoid sharp bends and edges. Use the plastic tie straps (BB) to secure the air line to fixed, non-moving points along the chassis. Be sure that the tie straps are tight, but do not pinch the air line. Leave at least 2" of slack to allow for any movement that might pull on the air line.

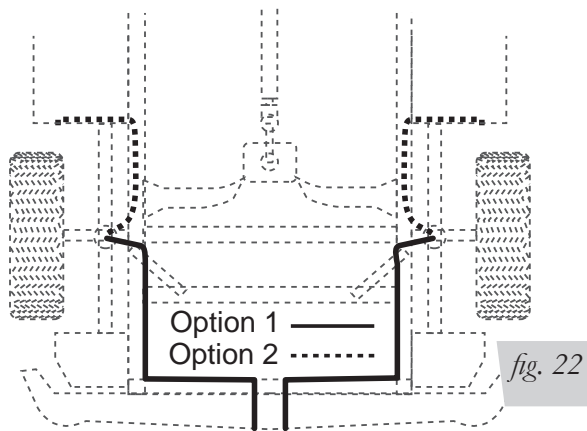
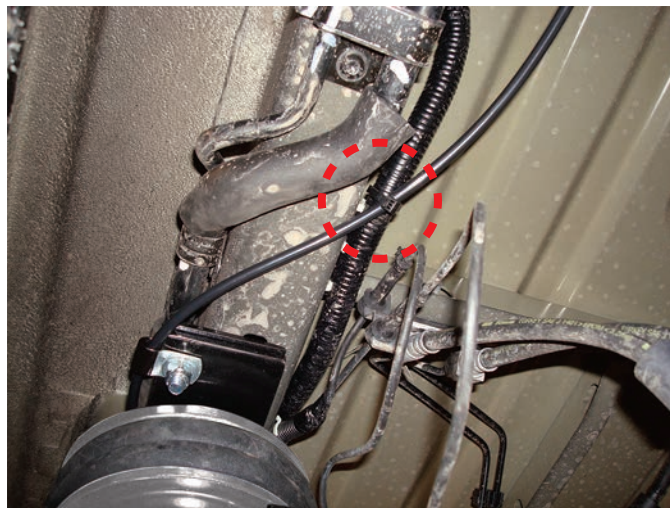

fig. 22

9. Cut off air line, leaving approximately 12" of extra air line. A clean square cut will ensure against leaks (see fig. 20). Route the hose through the P clamps previously installed, on both sides. This is especially important for the left (driver) side, to keep the airline away from the rear HVAC lines if equipped (figs. 23 and 24). Insert the airline into the fittings. This is a push-to-connect fitting. Simply push the air line into the 90° swivel fitting until it bottoms out (9/16" of air line should be in the fitting).



fig. 23



Tie off airline so as not to come in contact with HVAC lined if so equipped.

fig. 24

## INSTALLING THE HEAT SHIELD

**NOTE**

*Finished photo of heat shield installed on right-side (passenger) exhaust (fig. 25).*

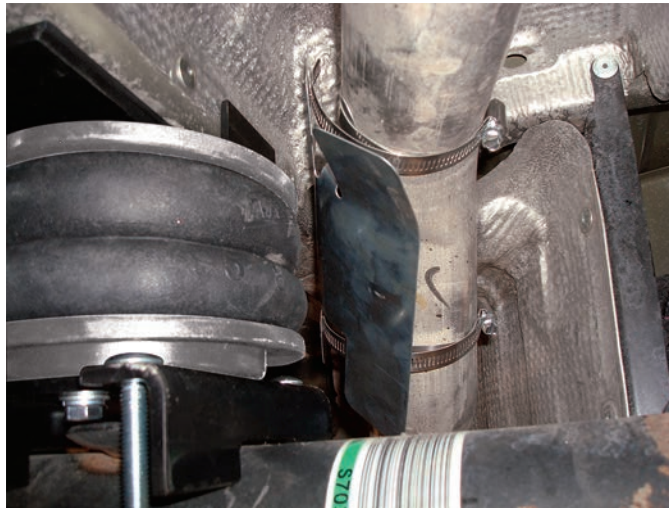

Forward view of the axle showing the heat shield in position on the exhaust.

*fig. 25*

1. Bend the tabs on the heat shield to provide a 1/2" dead air space between exhaust pipe and heat shield (fig. 26).

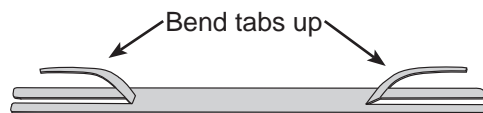

*fig. 26*

2. Attach the heat shield to the exhaust pipe using the clamps (fig. 27). Bend the heat shield for maximum clearance to the air spring.

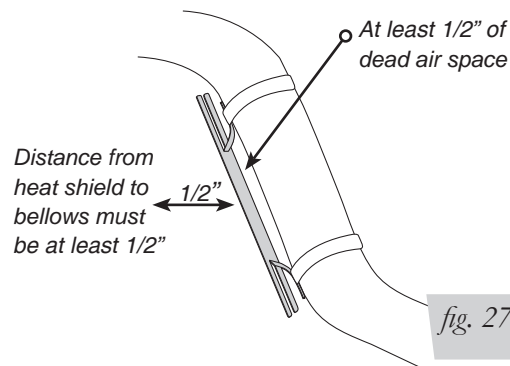

*fig. 27*

## CHECKING FOR LEAKS

1. Inflate the air spring to 30 PSI and spray all connections and the inflation valves with a solution of 1/5 liquid dish soap and 4/5 water to check for leaks. Spot leaks easily by looking for bubbles in the soapy water.
2. After the test, deflate the springs to the minimum pressure required to restore the normal ride height, no less than 5 PSI.
3. Check the air pressure again after 24 hours. A 2-4 PSI loss after initial installation is normal. Retest for leaks if the loss is more than 5 lbs.

## FIXING LEAKS

1. If there is a problem with the swivel fitting:
  - a. Check the air line connection by deflating the spring and removing the line by pulling the collar against the fitting and pulling firmly on the air line. Trim 1" off the end of the air line. Be sure the cut is clean and square (see fig. 20). Reinsert the air line into the push-to-connect fitting.
  - b. Check the threaded connection by tightening the swivel fitting another 1/2 turn. If it still leaks, deflate the air spring, remove the fitting, and re-coat the threads with thread sealant. Reinstall by hand tightening as much as possible, then use a wrench for an additional two turns.
2. If there is a problem with the inflation valve, then:
  - a. Check the valve core by tightening it with a valve core tool.
  - b. Check the air line connection by removing the air line from the barbed type fitting.



### CAUTION

DO NOT CUT THE AIR LINE COMPLETELY OFF AS THIS WILL NICK THE BARB AND RENDER THE FITTING USELESS.



## PHOTOS OF FINISHED ASSEMBLIES

1. Safely remove the jack stands by lowering or raising the vehicle.
2. Figure 28 shows the rear view of the left (driver side) completed installation.



*fig. 28*

3. Figure 29 shows the rear view of the right (passenger side) completed installation.



*fig. 29*

# Before Operating

## INSTALLATION CHECKLIST (To be completed by installer)

- Clearance test — Inflate the air springs to 60 PSI and ensure there is at least 1/2" clearance around each bellow, away from anything that might rub against them. Be sure to check the tire, brake drum, frame, shock absorbers and brake cables.
- Leak test before road test — Inflate the air springs to 60 PSI, check all connections for leaks with a soapy water solution. See the *Checking for Leaks* section for tips on how to spot leaks. All leaks must be eliminated before the vehicle is road tested.
- Heat test — Be sure there is sufficient clearance from any heat sources — at least 6" for air springs and air lines. If a heat shield was included in the kit, install it. If there is no heat shield, but one is required, call (800) 248-0892.
- Fastener test — Recheck all bolts for proper torque. Re-torque after 100 miles.
- Road test — The vehicle should be road tested after the preceding tests. Inflate the air springs to 25 PSI (50 PSI if the vehicle is loaded). Drive the vehicle 10 miles and recheck for clearance, loose fasteners and air leaks.
- Operating instructions — If professionally installed, the installer should review the *Product Use, Maintenance and Servicing* section with the owner. Be sure to provide the owner with all of the paperwork which came with the kit.

**Technician's Signature** \_\_\_\_\_

**Date** \_\_\_\_\_

## POST-INSTALLATION CHECKLIST

- Overnight leak down test — Recheck air pressure after the vehicle has been used for 24 hours. If the pressure has dropped more than 5 PSI, then there is a leak that must be fixed. Either fix the leak yourself or return to the installer for service.
- Air pressure requirements — Regardless of load, the air pressure should always be adjusted to maintain ride height at all times.
- Thirty day or 500 mile test — Recheck the air spring system after 30 days or 500 miles, whichever comes first. If any part shows signs of rubbing or abrasion, the source should be identified and moved, if possible. If it is not possible to relocate the cause of the abrasion, the air spring may need to be remounted. If professionally installed, the installer should be consulted. Check all fasteners for tightness.

# Product Use, Maintenance and Servicing

| Minimum Recommended Pressure | Maximum Air Pressure |
|------------------------------|----------------------|
| 5 PSI                        | 100 PSI              |

## MAINTENANCE GUIDELINES

### NOTE

*By following the steps below, vehicle owners will obtain the longest life and best results from their air springs.*

1. Check the air pressure weekly.
2. Always maintain normal ride height. Never inflate beyond 100 PSI.
3. If you develop an air leak in the system, use a soapy water solution (1/5 liquid dish soap and 4/5 water) to check all air line connections and the inflation valve core before deflating and removing the air spring.

### CAUTION

FOR YOUR SAFETY AND TO PREVENT POSSIBLE DAMAGE TO YOUR VEHICLE, DO NOT EXCEED MAXIMUM GROSS VEHICLE WEIGHT RATING (GVWR), AS INDICATED BY THE VEHICLE MANUFACTURER. ALTHOUGH YOUR AIR SPRINGS ARE RATED AT A MAXIMUM INFLATION PRESSURE OF 100 PSI, THE AIR PRESSURE ACTUALLY NEEDED IS DEPENDANT ON YOUR LOAD AND GVWR.

4. Loaded vehicles require at least 25 PSI or more. A “loaded vehicle” refers to a vehicle with a heavy bed load, a trailer, or both. As discussed above, never exceed GVWR, regardless of air spring, air pressure, or other load assist. The springs in this kit will support approximately 40 lbs. of load (combined on both springs) for each 1 PSI of pressure. The required air pressure will vary depending on the state of the original suspension. Operating the vehicle below the minimum air spring pressure will void the Air Lift warranty.
5. When increasing load, always adjust the air pressure to maintain the normal ride height. Increase or decrease pressure from the system as necessary to attain normal ride height for optimal ride and handling. Remember that loads carried behind the axle (including tongue loads) require more leveling force (pressure) than those carried directly over the axle.
6. Always add air to springs in small quantities, checking the pressure frequently.
7. Should it become necessary to raise the vehicle by the frame, make sure the system is at minimum pressure (5 PSI) to reduce the tension on the suspension/brake components. Use of on board leveling systems do not require deflation or disconnection.
8. Periodically check the air spring system fasteners for tightness. Also, check the air springs for any signs of rubbing. Realign if necessary.
9. On occasion, give the air springs a hard spray with a garden hose in order to remove mud, sand, gravel or other abrasive debris.

## TROUBLESHOOTING GUIDE

1. Leak test the air line connections, the threaded connection into the air spring, and all fittings in the control system.
2. Inspect the air lines to be sure none are pinched. Tie straps may be too tight. Loosen or replace the strap and replace leaking components.
3. Inspect the air line for holes and cracks. Replace as needed.
4. Look for a kink or fold in the air line. Reroute as needed.

## FREQUENTLY ASKED QUESTIONS

### Q. Will installing air springs increase the weight ratings of a vehicle?

No. Adding air springs will not change the weight ratings (GAWR, GCWR and/or GVWR) of a vehicle. Exceeding the GVWR is dangerous and voids the Air Lift warranty.

### Q. Is it necessary to keep air in the air springs at all times and how much pressure will they need?

For LoadLifter 5000 Ultimate, the recommended minimum air pressure is 5 PSI, but it can safely be run at zero air pressure.

### Q. Is it necessary to add a compressor system to the air springs?

No. Air pressure can be adjusted with any type of compressor as long as it can produce sufficient pressure to service the springs. Even a bicycle tire pump can be used, but it's a lot of work.

### Q. How long should air springs last?

If the air springs are properly installed and maintained they can last indefinitely.

### Q. Will raising the vehicle on a hoist for service work damage the air springs?

No. The vehicle can be lifted on a hoist for short-term service work such as tire rotation or oil changes. However, if the vehicle will be on the hoist for a prolonged period of time, support the axle with jack stands in order to take the tension off of the air springs.

## TUNING THE AIR PRESSURE

Pressure determination comes down to three things — level vehicle, ride comfort, and stability.

### 1. Level vehicle

If the vehicle's headlights are shining into the trees or the vehicle is leaning to one side, then it is not level (fig. 2.1). Raise the air pressure to correct either of these problems and level the vehicle.

### 2. Ride comfort

If the vehicle has a rough or harsh ride it may be due to either too much pressure or not enough (fig. 2.2). Try different pressures to determine the best ride comfort.

### 3. Stability

Stability translates into safety and should be the priority, meaning the driver may need to sacrifice a perfectly level and comfortable ride. Stability issues include roll control, bounce, dive during braking and sponginess (fig. 2.3). Tuning out these problems usually requires an increase in pressure.

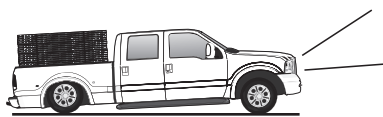

Bad headlight aim *fig. 2.1*



Rough ride *fig. 2.2*

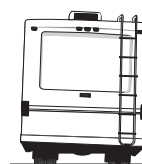

Sway and body roll *fig. 2.3*

## GUIDELINES FOR ADDING AIR

1. Start with the vehicle level or slightly above.
2. When in doubt, always add air.
3. If the front of the vehicle dives while braking, increase the pressure in the front air bags, if equipped.
4. If it is ever suspected that the air bags have bottomed out, increase the pressure (fig. 2.4).
5. Adjust the pressure up and down to find the best ride.
6. If the vehicle rocks and rolls, adjust the air pressure to reduce movement.
7. It may be necessary to maintain different pressures on each side of the vehicle. Loads such as water, fuel, and appliances will cause the vehicle to be heavier on one side (fig. 2.5). As much as a 50 PSI difference is not uncommon.

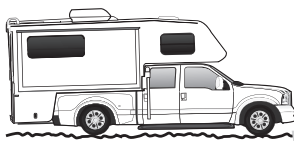

Bottoming out

*fig. 2.4*

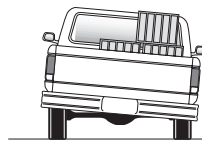

Unlevel

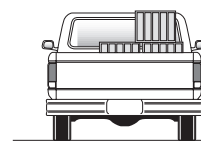

Level

*fig. 2.5*

# Choosing the Right On-Board Air Compressor System

**60 DAY** NO QUESTIONS ASKED, MONEY-BACK GUARANTEE

**TWO YEAR** COMPRESSOR SYSTEM WARRANTY

Add an on-board air compressor system to inflate and deflate your air springs with the touch of a button — from inside or outside of the vehicle.

- For convenient, on-the-go control of your air springs, add an Air Lift on-board air compressor system.
- Air Lift on-board air compressor systems eliminate the search for gas stations that have a working compressor, saving you time, energy and money.
- All systems include a compressor, controller and all parts needed for easy installation.

### 1. Choose single or dual path inflation (see illustrations at right)

#### 2. Choose wireless or analog control

- **Wireless:** Control your air springs from inside or outside the vehicle. Easiest installation - no wires to the cab.
- **Analog:** In-cab control of your air springs. Economically priced.

#### 3. Choose heavy or standard duty compressor

- **Standard duty:** A standard duty compressor will work well for most customers who use their system on an intermittent basis.
- **Heavy duty:** For daily use, consider the heavy duty compressor - it inflates faster and more quietly than the standard compressor.

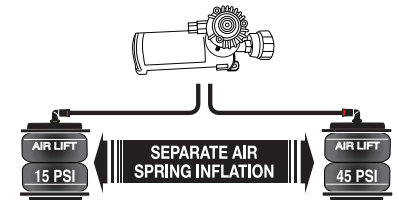

*Dual path systems* Air springs are controlled separately to allow for different air pressure from side-to-side. Perfect for uneven or top-heavy loads.

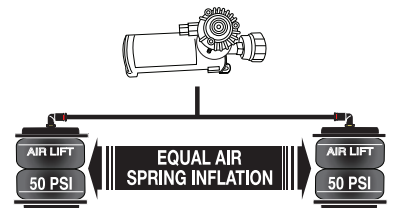

*Single path systems* Two springs will inflate at the same time. Good for loads that are evenly distributed from left-to-right or front-to-back.

## W I R E L E S S

## A N A L O G

DUAL PATH

### WirelessAIR™

**PATENTED!**

- Easy installation
- Includes heavy duty compressor



P/N 72000

### LoadCONTROLLER™

#### Dual

Compact, economically priced control.



P/N Standard Duty Compressor 25850; P/N Heavy Duty Compressor 25854

SINGLE PATH

### WirelessONE™

**PATENTED!**

- Easy installation
- Includes standard duty compressor



P/N 25870

### LoadCONTROLLER™

#### Single

Compact, economically priced control.

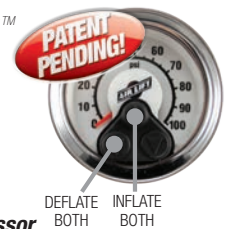

P/N Standard Duty Compressor 25852; P/N Heavy Duty Compressor 25856

---

# Replacement Information

- Parts are missing from the kit.
- Need technical assistance on installation or operation.
- Broken or defective parts in the kit.
- Wrong parts in the kit.
- Have a warranty claim or question.

**Contact the retailer where the kit was purchased:**

- If it is necessary to return or exchange the kit for any reason.
- If there is a problem with shipping if shipped from the retailer.
- If there is a problem with the price.